

RoHS MLE Varistor Series



Size Table

Metric	EIA
1005	0402
1608	0603
2012	0805
3216	1206

Applications

- Protection of components and circuits sensitive to ESD Transients occurring on power supplies, control and signal lines
- Suppression of ESD events such as specified in IEC-61000-4-2 or MIL-STD-883C Method-3015.7, for electromagnetic compliance (EMC)
- Used in mobile communications, computer/EDP products, medical products, hand held/portable devices, industrial equipment, including diagnostic port protection and I/O interfaces

Description

The MLE Series family of transient voltage suppression devices are based on the Littelfuse multilayer fabrication technology. These components are designed to suppress ESD events, including those specified in IEC 61000-4-2 or other standards used for Electromagnetic Compliance testing. The MLE Series is typically applied to protect integrated circuits and other components at the circuit board level operating at $18V_{DC}$ or less.

The fabrication method and materials of these devices result in capacitance characteristics suitable for high frequency attenuation/low-pass filter circuit functions, thereby providing suppression and filtering in a single device.

The MLE Series is manufactured from semiconducting ceramics and is supplied in a leadless, surface mount package. The MLE Series is compatible with modern reflow and wave soldering procedures.

Littelfuse Inc. manufactures other Multilayer Series products. See the ML Series data sheet for higher energy/peak current transient applications. See the AUML Series for automotive applications and the MLN Quad Array. For high-speed applications see the MHS Series.

Features

- AEC - Q200 compliant
- RoHS Compliant
- Rated for ESD (IEC-61000-4-2)
- Characterized for impedance and capacitance
- -55°C to $+125^{\circ}\text{C}$ operating temp. range
- Leadless 0402, 0603, 0805, and 1206 sizes
- Operating voltages up to $18V_{M(DC)}$
- Multilayer ceramic construction technology

Absolute Maximum Ratings

- For ratings of individual members of a series, see device ratings and specifications table.

Continuous	MLE Series	Units
Steady State Applied Voltage:		
DC Voltage Range ($V_{M(DC)}$)	≤ 18	V
Operating Ambient Temperature Range (T_A)	-55 to $+125$	$^{\circ}\text{C}$
Storage Temperature Range (T_{STG})	-55 to $+150$	C

Device Ratings and Specifications

Part Number	Max Continuous Working Voltage -55°C to 125°C	Performance Specifications (25°C)					
		Nominal Voltage		Maximum Clamping Voltage at Specified Current (8/20μs)	Maximum ESD Clamp Voltage (Note 2)		Typical Capacitance at 1MHz
		(Note 1) $V_{M(DC)}$ (V)	V_{NOM} at 1mA DC MIN (V) MAX (V)		8kV Contact (Note 3) (V)	15kV Air (Note 4) Clamp (V)	
V18MLE0402N	18	22	28	50 at 1A	<125	<110	<55
V18MLE0603N	18	22	28	50 at 1A	<75	<110	<125
V18MLE0603LN	18	22	28	50 at 1A	<100	<140	<100
V18MLE0805N	18	22	28	50 at 1A	<70	<75	<500
V18MLE0805LN	18	22	28	50 at 1A	<75	<135	<100
V18MLE1206N	18	22	28	50 at 1A	<65	<65	<1700

- NOTES:
- For applications of 18V_{DC} or less. Higher voltages available, contact your Littelfuse Sales Representative.
 - Tested with IEC-61000-4-2 Human Body Model (HBM) discharge test circuit.
 - Direct discharge to device terminals (IEC preferred test method).
 - Corona discharge through air (represents actual ESD event).
 - Capacitance may be customized, contact your Littelfuse Sales Representative.
 - Leakage current ratings are at 18V_{DC} and 25μA maximum.

Peak Current and Energy Derating Curve

For applications exceeding 125°C ambient temperature, the peak surge current and energy ratings must be reduced as shown below.

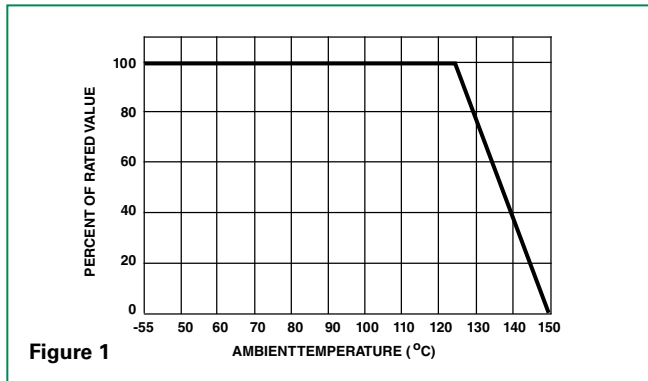

Nominal Voltage Stability to Multiple ESD Impulses (8kV Contact Discharges per IEC 61000-4-2)

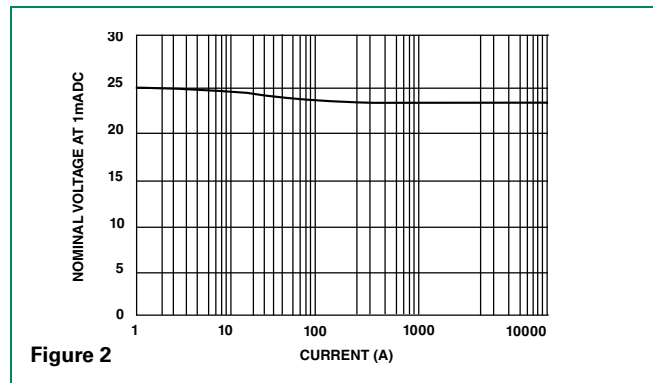

Standby Current at Normalized Varistor Voltage and Temperature

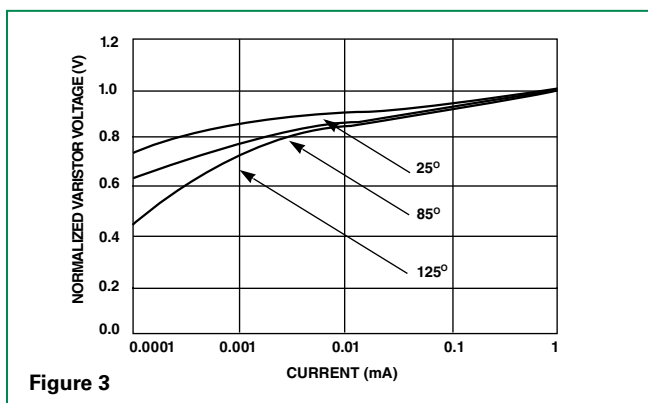

Impedance (Z) vs Frequency Typical Characteristic

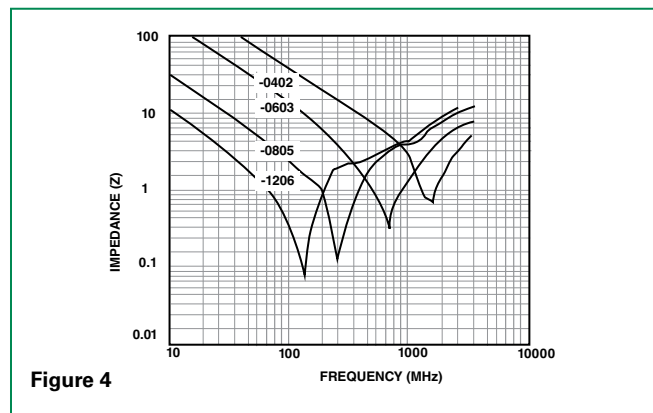

Device Characteristics

At low current levels, the V-I curve of the multilayer transient voltage suppressor approaches a linear (ohmic) relationship and shows a temperature dependent effect. At or below the maximum working voltage, the suppressor is in a high resistance model (approaching $10^6\Omega$ at its maximum rated working voltage). Leakage currents at maximum rated voltage are below $100\mu A$, typically $25\mu A$; for 0402 size below $20\mu A$, typically $5\mu A$.

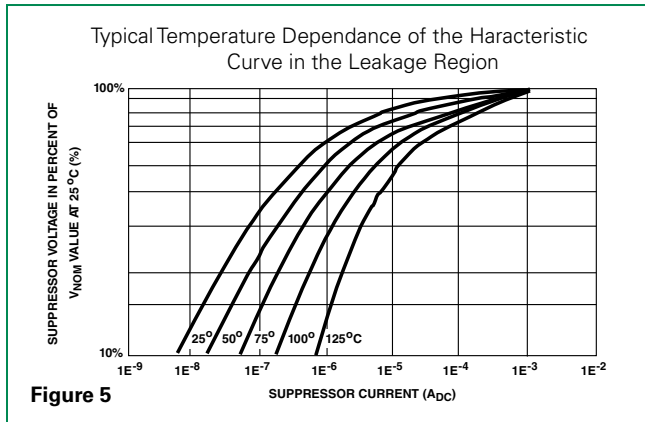

Figure 5

Speed of Response

The Multilayer Suppressor is a leadless device. Its response time is not limited by the parasitic lead inductances found in other surface mount packages. The response time of the $Z_{N}O$ dielectric material is less than 1ns and the MLE can clamp very fast dV/dT events such as ESD. Additionally, in "real world" applications, the associated circuit wiring is often the greatest factor effecting speed of response. Therefore, transient suppressor placement within a circuit can be considered important in certain instances.

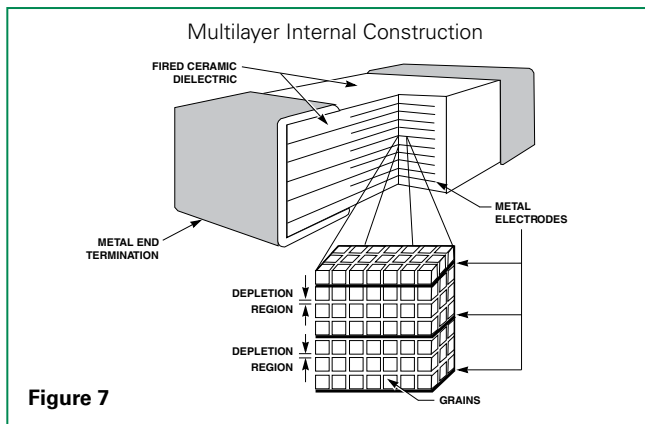

Figure 7

Clamping Voltage Over Temperature (V_c at 10A)

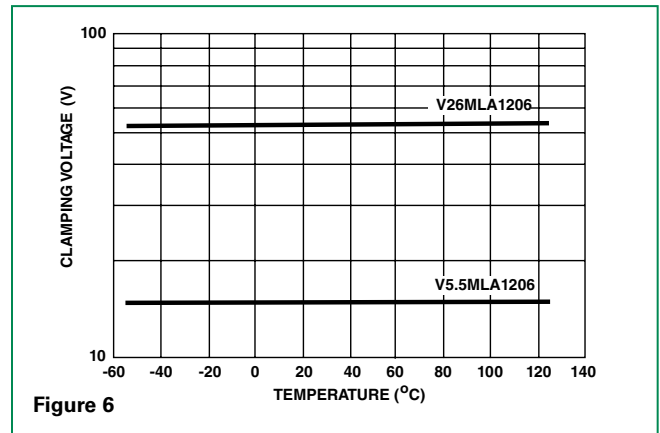

Figure 6

Energy Absorption/Peak Current Capability

Energy dissipated within the MLE is calculated by multiplying the clamping voltage, transient current and transient duration. An important advantage of the multilayer is its interdigitated electrode construction within the mass of dielectric material. This results in excellent current distribution and the peak temperature per energy absorbed is very low. The matrix of semiconducting grains combine to absorb and distribute transient energy (heat) (see Speed of Response). This dramatically reduces peak temperature; thermal stresses and enhances device reliability.

As a measure of the device capability in energy and peak current handling, the V26MLA1206A part was tested with multiple pulses at its peak current rating (150A, 8/20 μs). At the end of the test, 10,000 pulses later, the device voltage characteristics are still well within specification.

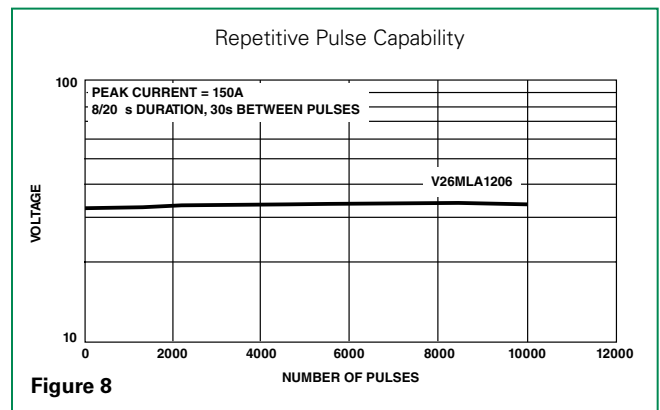

Figure 8

Lead (Pb) Soldering Recommendations

The principal techniques used for the soldering of components in surface mount technology are IR Re-flow and Wave soldering. Typical profiles are shown on the right.

The recommended solder for the MLE suppressor is a 62/36/2 (Sn/Pb/Ag), 60/40 (Sn/Pb) or 63/37 (Sn/Pb). Littelfuse also recommends an RMA solder flux.

Wave soldering is the most strenuous of the processes. To avoid the possibility of generating stresses due to thermal shock, a preheat stage in the soldering process is recommended, and the peak temperature of the solder process should be rigidly controlled.

When using a reflow process, care should be taken to ensure that the MLE chip is not subjected to a thermal gradient steeper than 4 degrees per second; the ideal gradient being 2 degrees per second. During the soldering process, preheating to within 100 degrees of the solder's peak temperature is essential to minimize thermal shock.

Once the soldering process has been completed, it is still necessary to ensure that any further thermal shocks are avoided. One possible cause of thermal shock is hot printed circuit boards being removed from the solder process and subjected to cleaning solvents at room temperature. The boards must be allowed to cool gradually to less than 50°C before cleaning.

Reflow Solder Profile

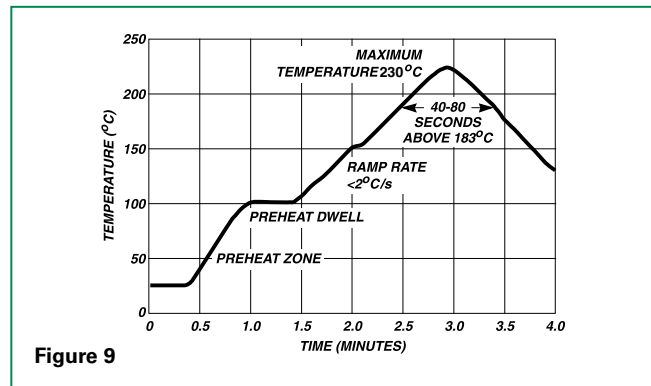

Figure 9

Wave Solder Profile

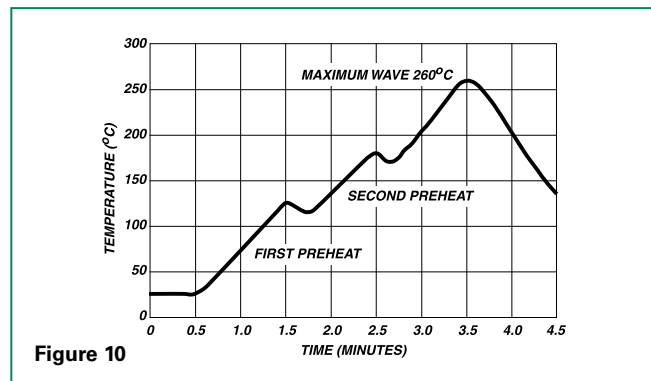

Figure 10

Lead-free (Pb-free) Soldering Recommendations

Littelfuse offers the Nickel Barrier Termination finish for the optimum Lead-free solder performance.

The preferred solder is 96.5/3.0/0.5 (SnAgCu) with an RMA flux, but there is a wide selection of pastes and fluxes available with which the Nickel Barrier parts should be compatible.

The reflow profile must be constrained by the maximums in the Lead-free Reflow Profile. For Lead-free Wave soldering, the Wave Solder Profile still applies.

Note: the Lead-free paste, flux and profile were used for evaluation purposes by Littelfuse, based upon industry standards and practices. There are multiple choices of all three available, it is advised that the customer explores the optimum combination for their process as processes vary considerably from site to site.

Lead-free Re-flow Profile

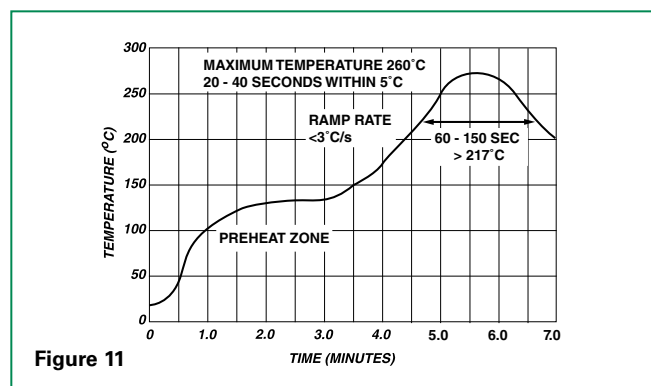
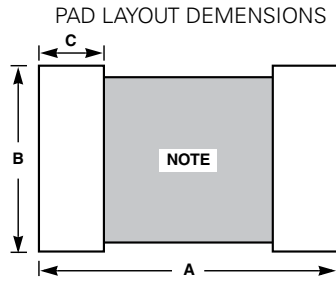
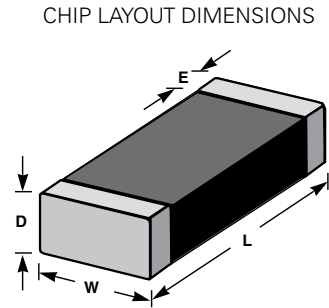

Figure 11

Product Dimensions (mm)



NOTE: Avoid metal runs in this area.
 Note: Avoid metal runs in this area, parts are not recommended for use in applications using Silver (Ag) epoxy paste.



Dimension	1206 Size		0805 Size		0603 Size		0402 Size	
	IN	MM	IN	MM	IN	MM	IN	MM
A	0.160	4.06	0.120	3.05	0.100	2.54	0.067	1.70
B	0.065	1.65	0.050	1.27	0.030	0.76	0.020	0.51
C	0.040	1.02	0.040	1.02	0.035	0.89	0.024	0.61
D (max.)	0.071	1.80	0.043	1.10	0.040	1.00	0.024	0.60
E	0.02 +/- 0.01	0.50 +/- 0.25	0.02 +/- 0.01	0.50 +/- 0.25	0.015 +/- 0.008	0.4 +/- 0.2	0.010 +/- 0.006	0.25 +/- 0.15
L	0.125 +/- 0.012	3.20 +/- 0.03	0.079 +/- 0.008	2.01 +/- 0.2	0.063 +/- 0.006	1.6 +/- 0.15	0.039 +/- 0.004	1.0 +/- 0.1
W	0.06 +/- 0.011	1.60 +/- 0.28	0.049 +/- 0.008	1.25 +/- 0.2	0.032 +/- 0.006	0.8 +/- 0.15	0.020 +/- 0.004	0.5 +/- 0.1

MLE Series

Part Numbering System

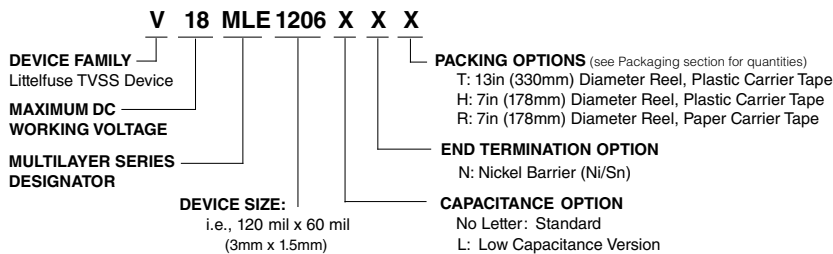

Packaging*

Device Size	Quantity			
	13" Inch Reel ('T' Option)	7" Inch Reel ('H' Option)	7" Inch Reel ('R' Option)	Bulk Pack ('A' Option)
1206	10,000	2,500	N/A	2500
0805	10,000	2,500	N/A	2500
0603	10,000	2,500	4,000	2500
0402	N/A	N/A	10,000	N/A

*(Packaging) It is recommended that parts be kept in the sealed bag provided and that parts be used as soon as possible when removed from bags.

Tape and Reel Specifications

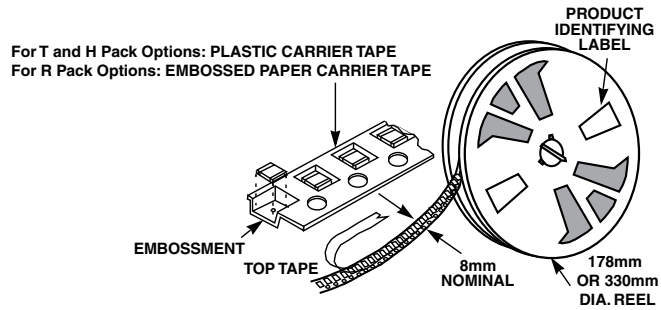
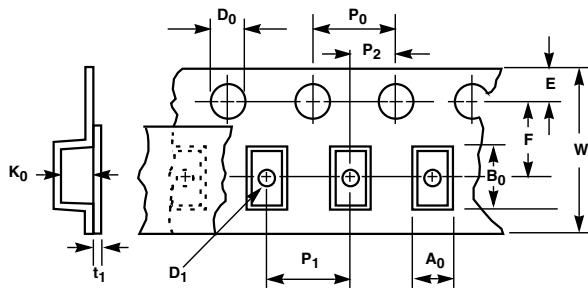

Symbol	Description	Dimensions in Millimeters	
		0402 Size	0603, 0805 & 1206 Sizes
A_0	Width of Cavity	Dependent on Chip Size to Minimize Rotation.	
B_0	Length of Cavity	Dependent on Chip Size to Minimize Rotation.	
K_0	Depth of Cavity	Dependent on Chip Size to Minimize Rotation.	
W	Width of Tape	8 +/- 0.2	8 +/- 0.3
F	Distance Between Drive Hole Centers and Cavity Centers	3.5 +/- 0.05	3.5 +/- 0.05
E	Distance Between Drive Hole Centers and Tape Edge	1.75 +/- 0.1	1.75 +/- 0.1
P_1	Distance Between Cavity Centers	2 +/- 0.05	4 +/- 0.1
P_2	Axial Drive Distance Between Drive Hole Centers & Cavity Centers	2 +/- 0.1	2 +/- 0.1
P_0	Axial Drive Distance Between Drive Hole Centers	4 +/- 0.1	4 +/- 0.1
D_0	Drive Hole Diameter	1.55 +/- 0.05	1.55 +/- 0.05
D_1	Diameter of Cavity Piercing	N/A	1.05 +/- 0.05
T_1	Top Tape Thickness	0.1 Max	0.1 Max

Notes :

- Conforms to EIA-481-1, Revision A
- Can be supplied to IEC publication 286-3