

# Interface and switching (60V, 115mA)

## RK7002

### ●Features

- 1) Low on-resistance.
- 2) Fast switching speed.
- 3) Low-voltage drive.
- 4) Easily designed drive circuits.
- 5) Easy to parallel.

### ●Structure

Silicon N-channel  
MOSFET

### ●External dimensions (Units: mm)

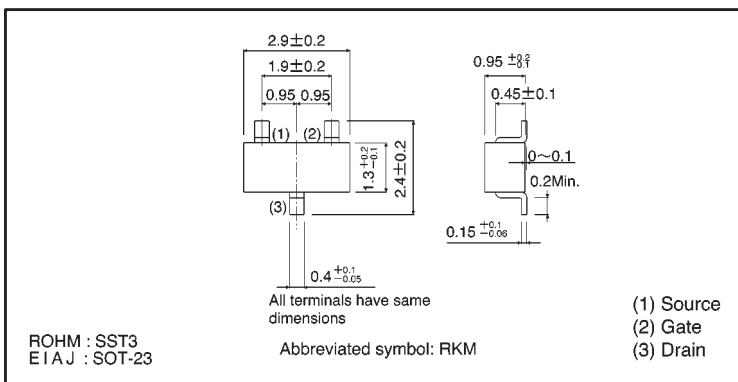

### ●Absolute maximum ratings (Ta = 25°C)

Parameter	Symbol	Limits	Unit
Drain-source voltage	$V_{DS}$	60	V
Gate-source voltage	$V_{GS}$	$\pm 20$	V
Drain current	Continuous	$I_D$	115 mA
	Pulsed	$I_{DP}^{*1}$	800 mA
Reverse drain current	Continuous	$I_{DR}$	115 mA
	Pulsed	$I_{DRP}^{*1}$	800 mA
Total power dissipation	$P_D^{*2}$	225	mW
Channel temperature	$T_{ch}$	150	°C
Storage temperature	$T_{stg}$	-55~+150	°C

\*1  $P_w \leq 10 \mu s$ , Duty cycle  $\leq 1\%$

\*2 When mounted on a  $1 \times 0.75 \times 0.062$  inch glass epoxy board.

### ●Equivalent circuit

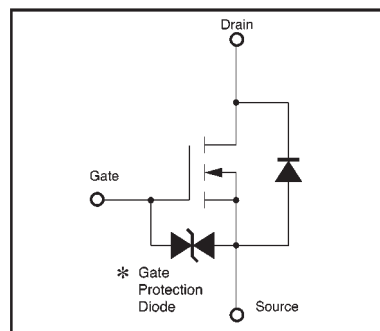

\* A protection diode has been built in between the gate and the source to protect against static electricity when the product is in use. Use the protection circuit when fixed voltages are exceeded.

●Electrical characteristics (Ta = 25°C)

Parameter	Symbol	Min.	Typ.	Max.	Unit	Test Conditions
Gate-source leakage	$I_{GSS}$	—	—	$\pm 10$	$\mu A$	$V_{GS} = \pm 20V, V_{DS} = 0V$
Drain-source breakdown voltage	$V_{(BR) DSS}$	60	—	—	V	$I_D = 10 \mu A, V_{GS} = 0V$
Zero gate voltage drain current	$I_{DSS}$	—	—	1.0	$\mu A$	$V_{DS} = 60V, V_{GS} = 0V$
Gate threshold voltage	$V_{GS(th)}$	1.0	1.85	2.5	V	$V_{DS} = 10V, I_D = 1mA$
Static drain-source on-state resistance	$R_{DS(on)*}$	—	—	7.5	$\Omega$	$I_D = 0.5A, V_{GS} = 10V$
		—	—	7.5		$I_D = 0.05A, V_{GS} = 5V$
Forward transfer admittance	$ Y_{fs} ^{*}$	80	—	—	mS	$I_D = 0.2A, V_{DS} = 10V$
Input capacitance	$C_{iss}$	—	25	50	pF	$V_{DS} = 25V$
Output capacitance	$C_{oss}$	—	10	25	pF	$V_{GS} = 0V$
Reverse transfer capacitance	$C_{rss}$	—	3.0	5.0	pF	$f = 1MHz$
Turn-on delay time	$t_{d(on)}^{*}$	—	12	20	ns	$I_D = 0.2A, V_{DD} = 30V, V_{GS} = 10V,$
Turn-off delay time	$t_{d(off)}^{*}$	—	20	30	ns	$R_L = 150\Omega, R_G = 10\Omega$

\*  $P_w \leq 300 \mu s, \text{Duty cycle} \leq 1\%$

●Packaging specifications

Type	Package	Taping
	Code	T116
	Basic ordering unit (pieces)	3000
RK7002		○

●Electrical characteristic curves

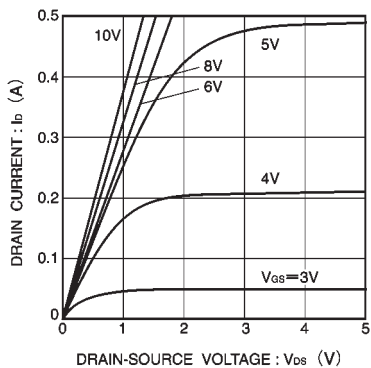

Fig.1 Typical output characteristics

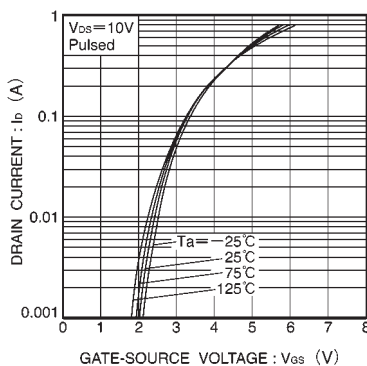

Fig.2 Typical transfer characteristics

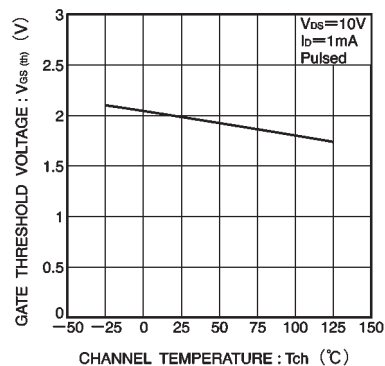

Fig.3 Gate threshold voltage vs. channel temperature

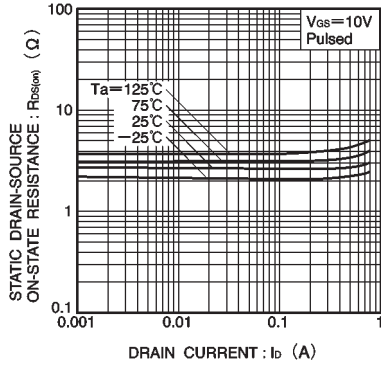

Fig. 4 Static drain-source on-state resistance vs. drain current ( I )

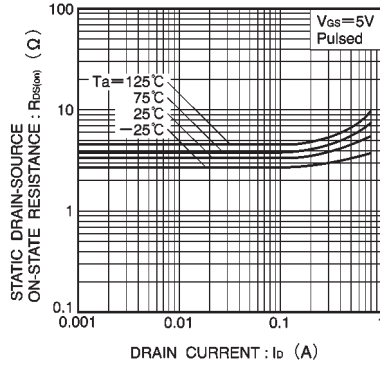

Fig. 5 Static drain-source on-state resistance vs. drain current ( II )

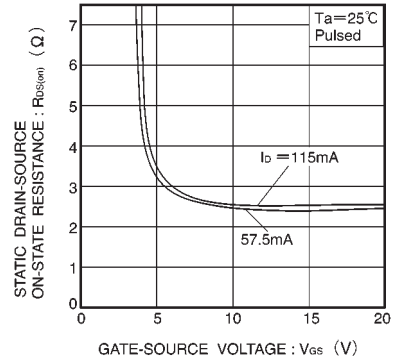

Fig. 6 Static drain-source on-state resistance vs. gate-source voltage

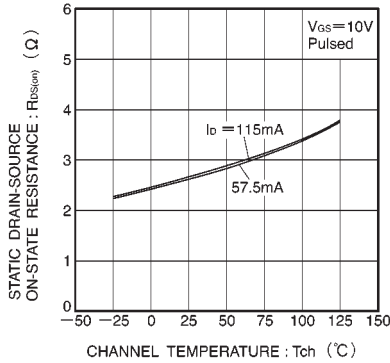

Fig. 7 Static drain-source on-state resistance vs. channel temperature

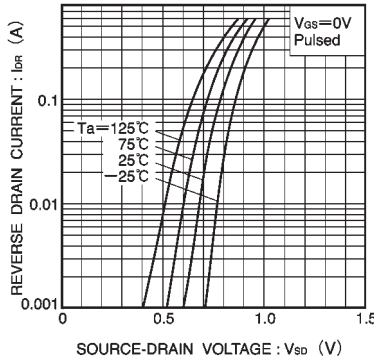

Fig. 8 Reverse drain current vs. source-drain voltage ( I )

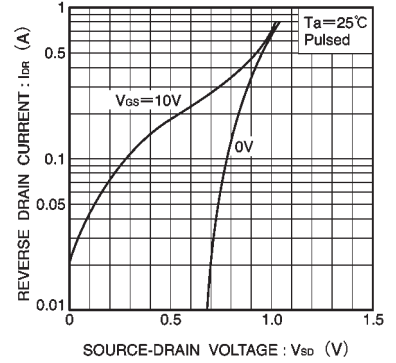

Fig. 9 Reverse drain current vs. source-drain voltage ( II )

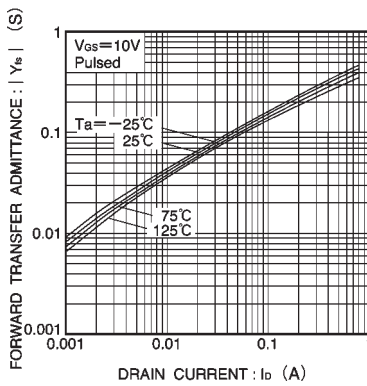

Fig. 10 Forward transfer admittance vs. drain current

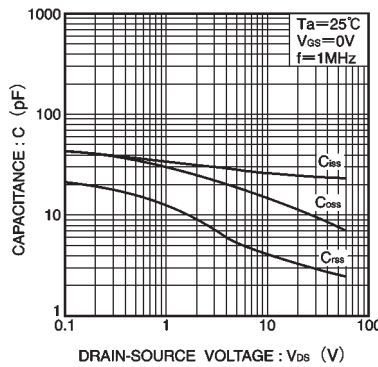

Fig. 11 Typical capacitance vs. drain-source voltage

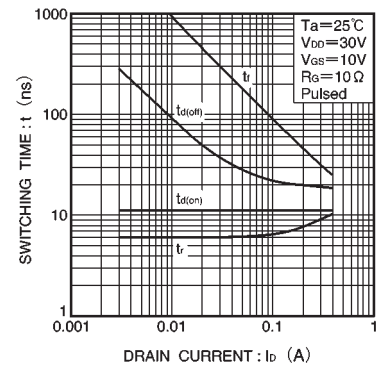

Fig. 12 Switching characteristics  
(See Figures 13 and 14 for the measurement circuit and resultant waveforms)

● Switching characteristics measurement circuit

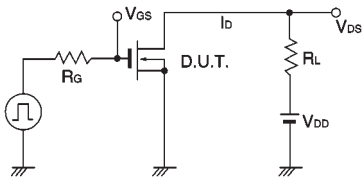

Fig.13 Switching time measurement circuit

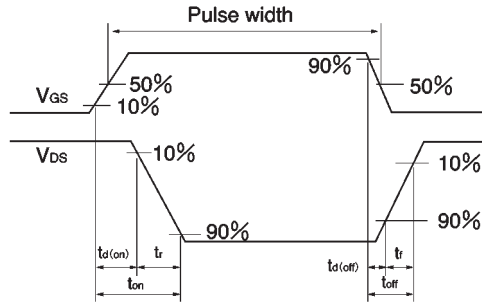

Fig.14 Switching time waveforms