



Reflective Interrupter

MODEL NO : _____ ITR9909 _____

■ Features :

- Fast response time
- High analytic
- Cut-off visible wavelength $\lambda_p=840\text{nm}$
- High sensitivity
- Pb free

■ Description :

The **ITR9909** consist of an infrared emitting diode and an NPN silicon phototransistor, encased side-by-side on converging optical axis in a black thermoplastic housing. The phototransistor receives radiation from the IRED only. This is the normal situation. But when an object is in between, phototransistor could not receives the radiation. For additional component information, please refer to **IR1254-R8** and **PT1254-6B**.

■ Applications :

- Mouse Copier
- Switch Scanner
- Non-contact Switching
- For Direct PC Board

PART NO.	CHIP	LENS COLOR
	MATERIAL	
IR	GaAlAs	Blue
PT	Silicon	Black



DEVICE NUMBER : DRX-909-104
ECN : _____

REV : 1.0
PAGE : 2/7

Reflective Interrupter

MODEL NO : ITR9909

Package Dimension :

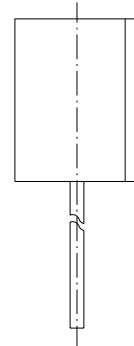
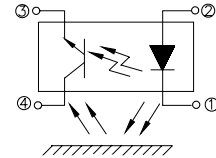
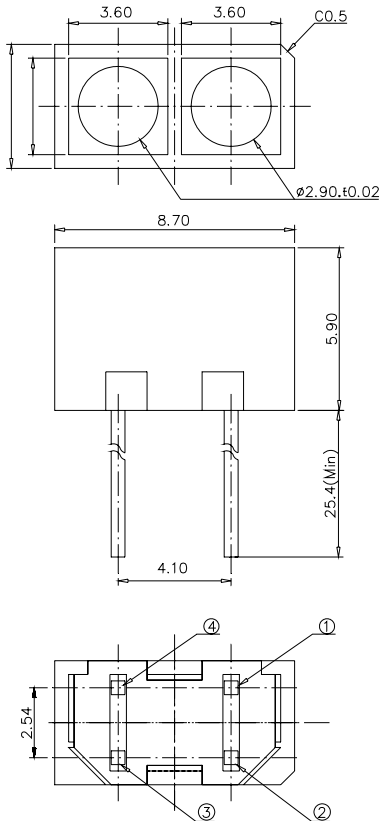

①: Cathode
②: Anode
③: Emitter
④: Collector

Notes :

1. All dimensions are in millimeter.
2. General tolerance: ± 0.2 mm
3. Lead spacing is measured where the lead emerge from the package.
4. Above specification may be changed without notice. EVERLIGHT will reserve authority on material change for above specification.
5. These specification sheets include materials protected under copyright of EVERLIGHT corporation . Please don't reproduce or cause anyone to reproduce them without EVERLIGHT's consent.
6. When using this product , please observe the absolute maximum ratings and the instructions for use outlined in these specification sheets. EVERIGHT assumes no responsibility for any damage resulting from use of the product which does not comply with the absolute maximum ratings and the instructions included in these specification sheets.



EVERLIGHT ELECTRONICS CO., LTD.

DEVICE NUMBER : DRX-909-104 REV : 1.0
 ECN : _____ PAGE : 3/7

Reflective Interrupter

MODEL NO : _____ ITR9909 _____

■ Absolute Maximum Ratings at T_A = 25°C

Parameter		Symbol	Rating	Unit
Input	Power Dissipation	P _D	100	mW
	Reverse Voltage	V _R	5	V
	Forward Current	I _F	50	mA
	Peak Forward Current(*1)	I _{FP}	1	A
Output	Collect Power Dissipation	P _C	75	mW
	Collect Current	I _C	20	mA
	Collector-Emitter Voltage	V _{CE}	30	V
	Emitter-Collector Voltage	V _{EC}	5	V
Operating Temperature		Topr	-25~+85	°C
Storage Temperature		Tstg	-40~+85	°C
Soldering Temperature(*2)		Tsol	260	°C

(*1) Pause width= 100 μs, Duty Cycle=1% (*2) t=5 secs

■ Electronic Optical Characteristics at T_A = 25°C:

Parameter		Symbol	Min.	Typ.	Max.	Unit	Condition
Input	Forward Voltage	V _{F1}	-	1.2	1.5	V	I _F =20mA
		V _{F2}	-	1.4	1.85		I _F =100mA, tp=100 μs, tp/T=0.01
		V _{F3}	-	2.6	4.0		I _F =1A, tp=100 μs, tp/T=0.01
	Reverse Current	I _R	-	-	10	μA	V _R =5V
	Peak Wavelength	λ _P	-	940	-	nm	I _F =20mA
View Angle		2θ 1/2	-	35	-	Deg	I _F =20mA
Output	Dark Current	I _{CEO}	-	-	100	nA	V _{CE} =20V, Ee=0mW/cm ²
	C-E Saturation Voltage	V _{CE(sat)}	-	-	0.4	V	I _C =2mA, Ee=1mW/cm ²
Collect Current		I _{C(ON)}	0.2	-	-	mA	V _{CE} =5V, I _F =20mA
Leakage Current		I _{CEO}	-	-	1	μA	
Response Time	Rise Time	t _R	-	15	-	μs	V _{CE} =5V, I _C =1mA, R _L =1KΩ
	Fall Time	t _F	-	15	-	μs	



EVERLIGHT ELECTRONICS CO., LTD.

DEVICE NUMBER : DRX-909-104 REV : 1.0
ECN : _____ PAGE : 4/7

Reflective Interrupter

MODEL NO : ITR9909

■ Typical Electrical/Optical/Characteristics Curves For IR

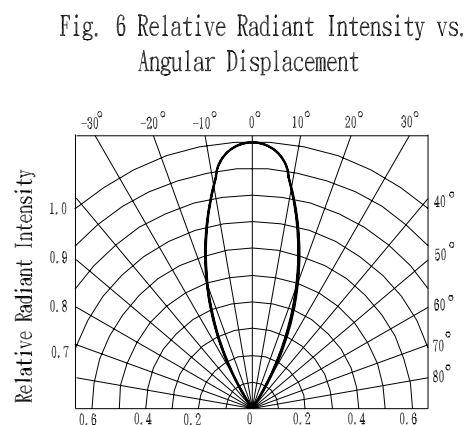
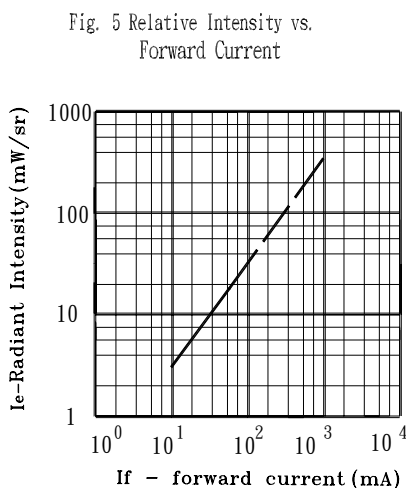
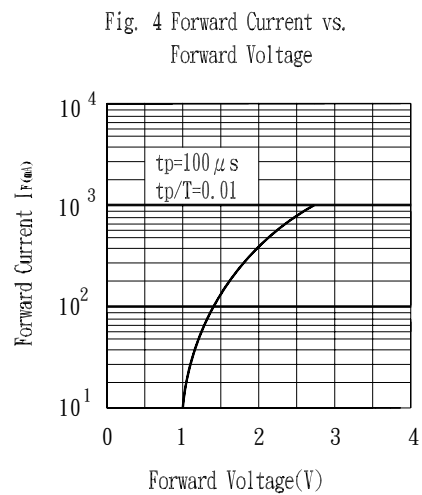
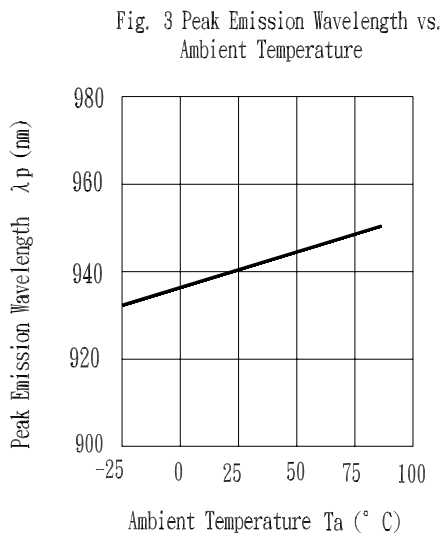
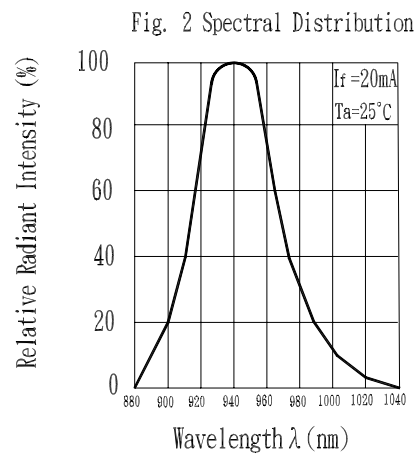
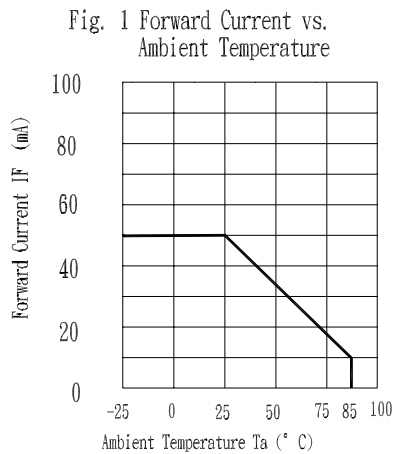



Reflective Interrupter

MODEL NO : ITR9909

Typical Electrical/Optical/Characteristics Curves For PT

Fig.1 Collector Power Dissipation vs. Ambient Temperature

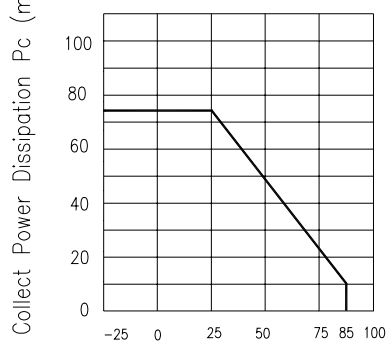

Ambient Temperature T_a (°C)

Fig.2 Collector Dark Current vs. Ambient Temperature

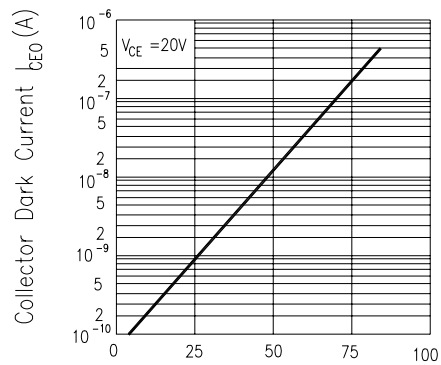

Ambient Temperature T_a (°C)

Fig. 3 Relative Collector Current vs. Ambient Temperature

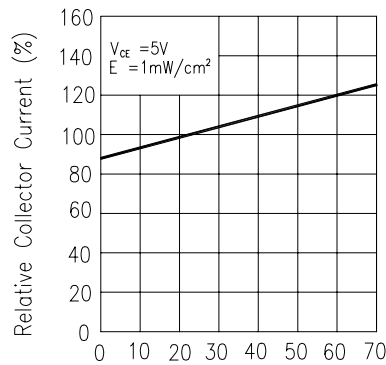

Ambient Temperature T_a (°C)

Fig.4 Collector Current vs. Irradiance

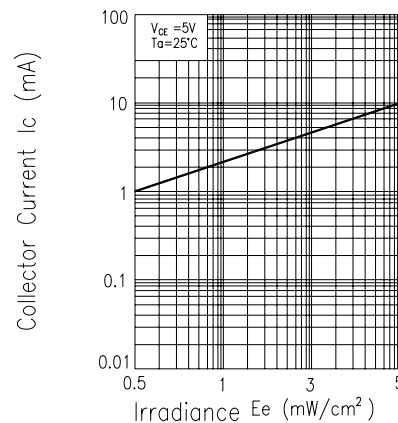

Irradiance E_e (mW/cm²)

Fig.5 Spectral Sensitivity

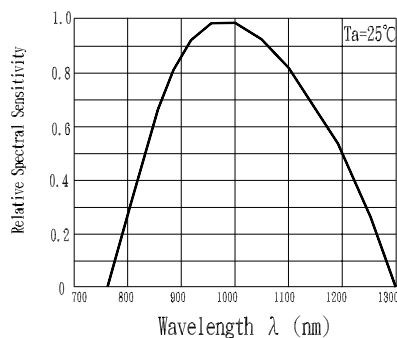

Wavelength λ (nm)

Fig.6 Collector Current vs. Collector-Emitter Voltage

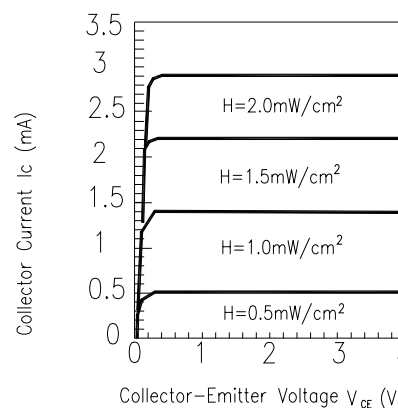

Collector-Emitter Voltage V_{CE} (V)



EVERLIGHT ELECTRONICS CO., LTD.

DEVICE NUMBER : DRX-909-104 REV : 1.0ECN : _____ PAGE : 6/7

Reflective Interrupter

MODEL NO : ITR9909

■ Reliability Test Item And Condition

The reliability of products shall be satisfied with items listed below.

Confidence level:90%

LTPD:10%

NO.	Item	Test Conditions	Test Hours/ Cycle	Sample Size	Failure Judgement Criteria	Ac/Re
1	Solder Heat	TEMP : 260°C ± 5 °C	5 secs	22 pcs	$I_{c(on)} \leq L \times 0.8$ L :Lower specification limit	0/1
2	Temperature Cycle	H : +85°C 30 mins \updownarrow 5 mins \updownarrow L : -55°C 30 mins	50 cycles	22 pcs		0/1
3	Thermal Shock	H : +100°C 5 mins \updownarrow 10 secs \updownarrow L : -10°C 5 mins	50 cycles	22 pcs		0/1
4	High Temperature Storage	TEMP. : +100°C	1000 hrs	22 pcs		0/1
5	Low Temperature Storage	TEMP. : -55°C	1000 hrs	22 pcs		0/1
6	DC Operating Life	$V_{CE}=5V$ $I_F=20mA$	1000 hrs	22 pcs		0/1
7	High Temperature / High Humidity	85°C / 85% R.H.	1000 hrs	22 pcs		0/1



EVERLIGHT ELECTRONICS CO., LTD.

DEVICE NUMBER : DRX-909-104 REV : 1.0
ECN : _____ PAGE : 7/7

Reflective Interrupter

MODEL NO : ITR9909

■ Packing Specifications

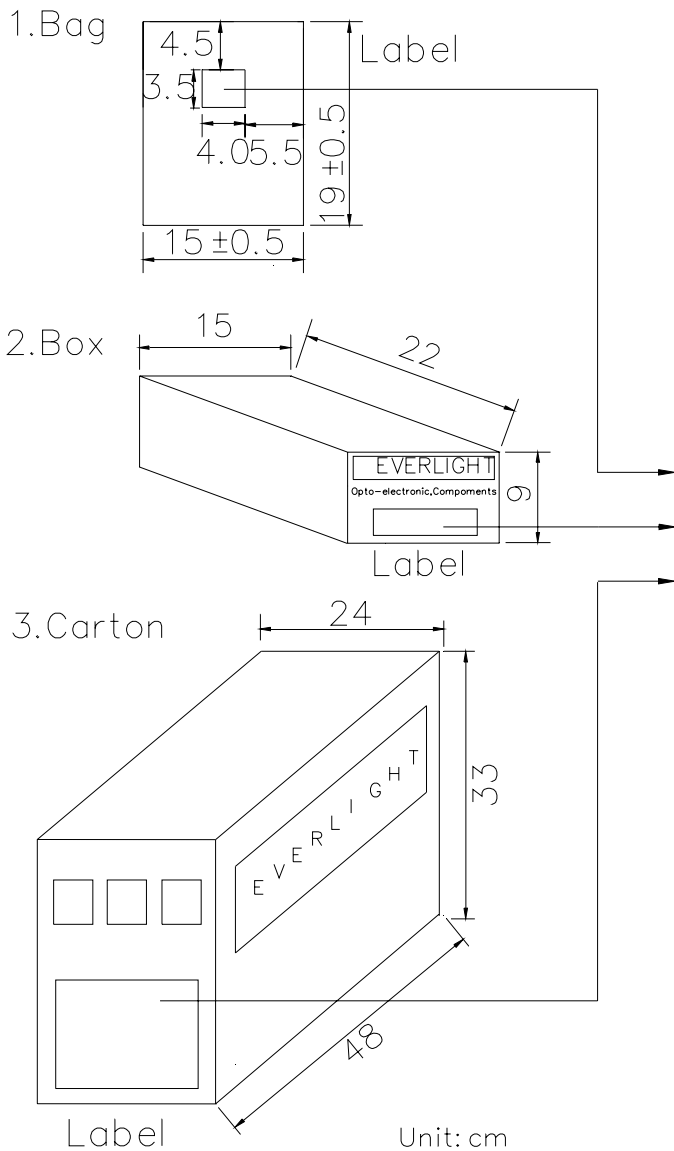

CPN:

P/N:



ITR9909

QTY:

CAT:



HUE:

REF:

LOT NO:

MADE IN TAIWAN

CPN : Customer's Production Number

P/N : Production Number

QTY : Packing Quantity

CAT : Ranks

HUE : Peak Wavelength

REF : Reference

LOT NO : Lot Number

MADE IN TAIWAN : Production place

■ **Packing Quantity Specification**

1.200Pcs/1Bag

2.6Bags/1Box

3.10Boxes/1Carton
