



## General

- Fast acting, Inrush withstand capability
- Surface mount high current fuse
- Available in ratings of 20 to 60 Amperes
- Higher voltage rating up to 100VDC
- 10.25mm×3.20mm square shape surface mount
- -55°C ~125°C Operating temperature
- Excellent environmental integrity
- Enhanced thermal cycling endurance
- RoHS compliant
- Halogen Free

## Agency / Certificate Information

Agency	File Number	Ampere Range
	E319512	20A~60A
	E319512	

## Application

- Storage system power
- Cooling fan system for PC server
- Voltage regulator module
- Base station power supply
- Voltage regulator module for PC server
- High end servers / Blade computing
- Battery Management System

## Electrical Specifications

Part Number	Current Rating (A)	Voltage Rating (V)	Interrupting Rating	Typical Cold DCR* (mΩ)	Nominal I <sup>2</sup> T** (A <sup>2</sup> s)
S1032-F-20A	20	100	100VDC 300A 72VDC 500A 32VDC 1000A	3.08	264
S1032-F-25A	25	100		2.15	413
S1032-F-30A	30	100		2.08	594
S1032-F-40A	40	72	72VDC 180A 60VDC 600A	1.23	1024
S1032-F-50A	50	72		1.00	1650
S1032-F-60A	60	72		0.88	2376

\* Measured at ≤10% rated current and 25°C

\*\* Melting I<sup>2</sup>T at 10 times of rated current

### Part Number Information

**S1032-F-40A**

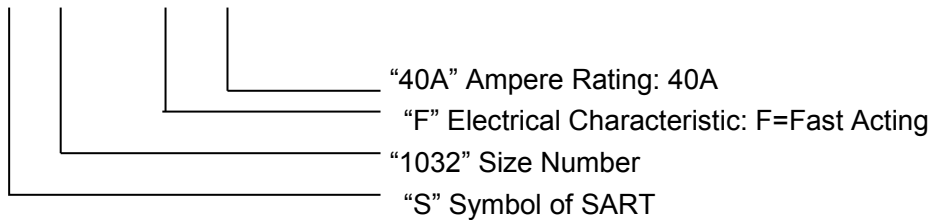

### Dimensions

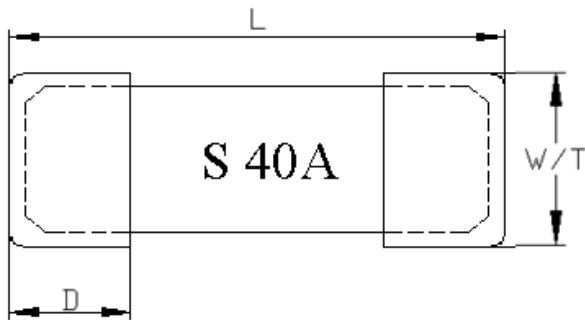

Type	L (mm)	W/T (mm)	D (mm)
S1032	10.25±0.20	3.20±0.15	1.75±0.15

### Recommended Land Patterns

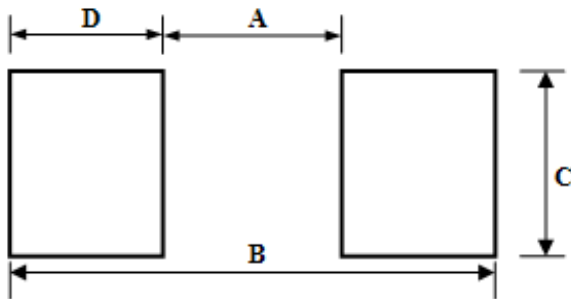

### Materials

Components	Material
Body	Ceramic
Terminations	Au Plated Brass Cap
Element	Tin Plated Copper

Dimensions	A(mm)	B (mm)	C(mm)	D(mm)
Spec	5.72±0.30	12.60±0.30	3.43±0.30	3.25±0.30

### Dimensions of Standard Test Board

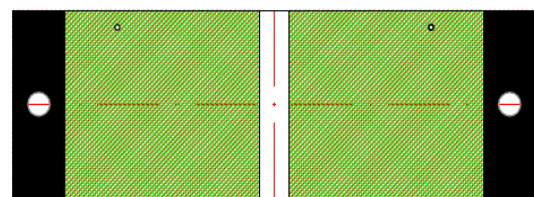
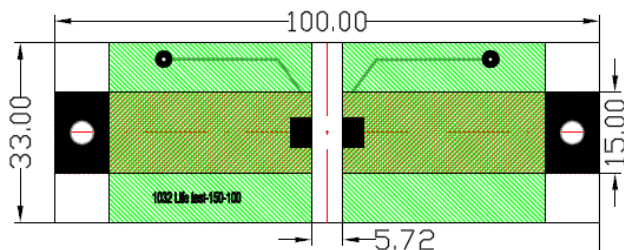

Glass epoxy body on double side;

Board thickness: 1.6mm; Thickness of Copper layer: ≥100µm;

Width of Copper trace: One side 15mm and the other side 33mm

### Time Current Curve

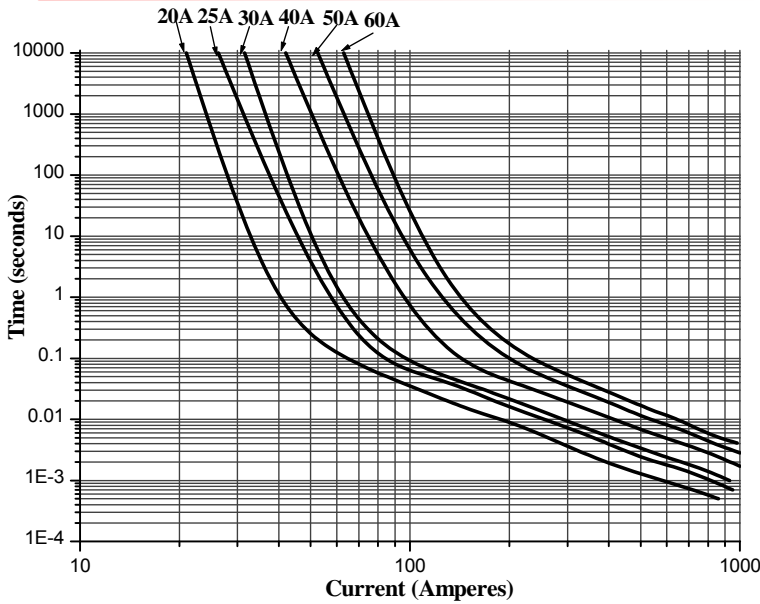

### I<sup>2</sup>T VS Time Curve

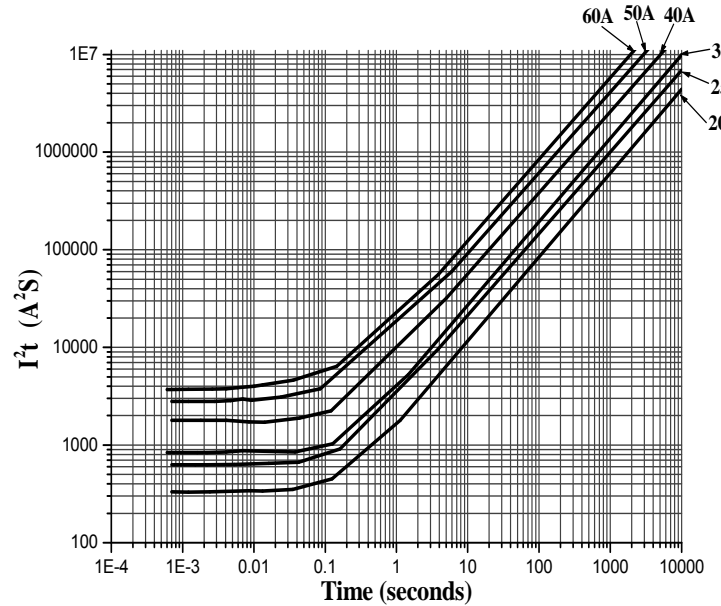

### Electrical Characteristics

Type	Ampere Rating	% of Current Rating	Opening Time
S1032	20A~60A	100	Min.4hours
	20A~60A	200	Max.60sec
	20A~60A	1000	Min. 1ms

### Temperature Derating Curve

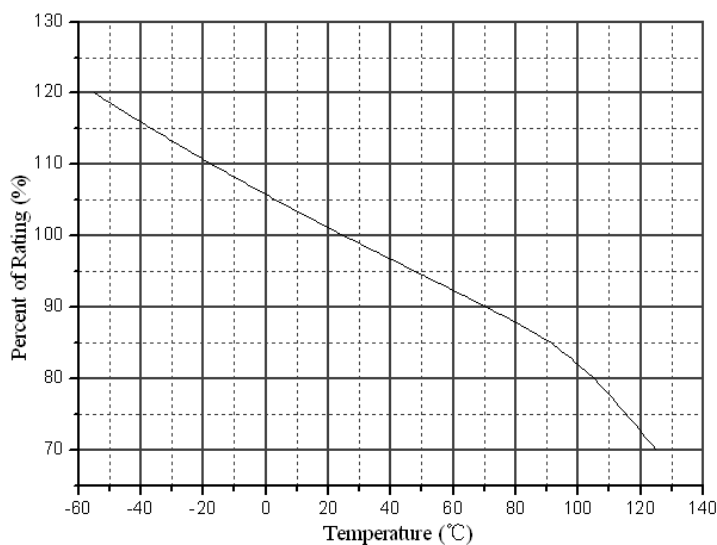

## Product Characteristics

Item	Test condition/ Methods		Performance	Standard
Time/Current	100% of current rating		No Fusing; 4hr Min.	UL248-14
	200% of current rating		60sec Max.	SART SPEC
	1000%of current rating		1ms Min.	SART SPEC
Endurance Test	100% of rating current for 4 hours and testing Temperature rise at the last 5min.		No fusing; 20A~40A: <90℃ 50A~60A: <105℃	UL248-14
Interrupting Ability	20A~30A	100VDC 300A 72VDC 500A 32VDC 1000A	without permanent arcing, ignition and bursting of fuse link	UL248-14 IEC60127-4
	40A~60A	72VDC 180A 60VDC 600A		
Solder ability	240℃±5℃, 3sec±0.5sec		95% coverage Min.	IEC60127-4 IEC60068-2-20; MIL-STD-202
Resistance to soldering	260℃±5℃, 10sec±0.5sec		No Breaking	MIL-STD-202 Method 210
Moisture resistance	Temperature Humidity, T: 85℃ ±3℃, RH: 85%±5%, Duration: 1000 hours		ΔR : <10% No mechanical damage	MIL-STD-202 Method 106
Low Temperature Storage	T=-55℃±3℃, 1000hours		ΔR : <10%	IEC60068-2-1
High Temperature Storage	T=125℃±2℃, 1000hours		ΔR : <10%	IEC60068-2-2
Salt Spray	5%±1% salt solution , 48hours		ΔR : <10%	MIL-STD-202 Method 101
Thermal Shock	100 cycles, -55℃ to +125℃, 30 minutes @ each extreme		ΔR : <10%	IEC 60068-2-14
Vibration	Amplitude 10Hz~55Hz in 1 min. 2 hours each XYZ, total 6 hours		ΔR : <10% No mechanical damage	MIL-STD-202F Method 201
Mechanical shock	100G's peak amplitude, saw tooth wave 6ms duration, 3 cycles XYZ+xyz = 18		ΔR : <10% No mechanical damage	MIL-STD-202 Method 213

## Recommended Solder Curve

- Infrared Reflow:
  - Temperature: 260°C
  - Time: 5sec Max.
  - Recommend Reflow profile

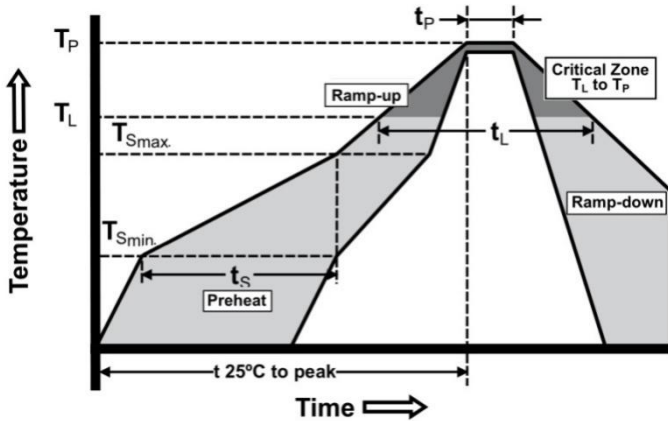

Profile Feature	Pb-Free Assembly
Average Ramp-Up Rate( $T_{Smax}$ to $T_p$ )	3°C/sec Max.
Preheat Temperature Min( $T_{Smin}$ ) Temperature Max( $T_{Smax}$ ) Time( $T_{Smin}$ to $T_{Smax}$ )	150°C 200°C 60sec ~ 120sec
Peak Temperature( $T_p$ )	260°C
Time within 5°C of actual Peak Temperature( $T_p$ )	5sec
Melting tin time( $T_L$ )	20sec ~ 40sec
Ramp-Down Rate	6°C/sec Max.
Time 25°C to Peak Temperature	8 min Max.

- Wave soldering
  - Reservoir Temperature: 260°C
  - Time in Reservoir: 10sec Max

- Hand Soldering
  - Temperature: 350°C
  - Time: 3sec Max.
  - Avoid Soldering iron touch with Brass Cap.

## Packaging

- 2000 pieces of fuses on 24mm tape-and-reel on 13 inch (330mm) reel

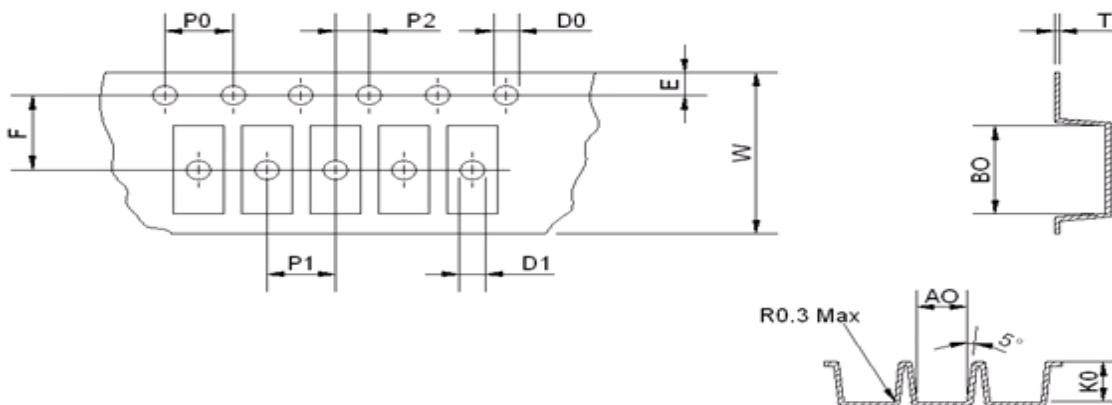

Type	A0(mm)	B0(mm)	E(mm)	F(mm)	W(mm)	K0(mm)
Spec	3.50±0.10	10.60±0.15	1.75±0.10	11.50±0.10	24.00±0.30	3.50±0.10
Type	P0(mm)	P1(mm)	P2(mm)	D0(mm)	D1(mm)	T(mm)
Spec	4.00±0.10	8.00±0.10	2.00±0.10	150 <sup>+0.10</sup> <sub>-0</sub>	150 <sup>+0.10</sup> <sub>-0</sub>	0.35±0.05

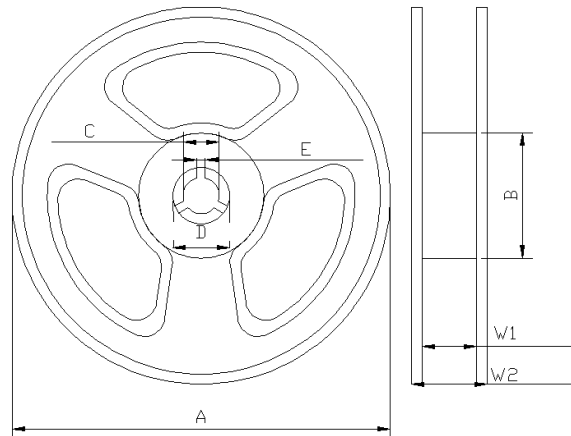

Type	A(mm)	B(mm)	C(mm)	D(mm)	E(mm)	W1(mm)	W2(mm)
Spec	330.0±2.0	100.0±1.5	13.0±0.5	21.0±0.5	2.2±0.2	24.5±1.5	28.5±2.0

## Storage

- The ambient temperature recommended for storage shall be between 5°C~30°C.
- The relative humidity recommended for storage shall be between 25%RH~60%RH.
- Sealed plastic bags with desiccant shall be used to reduce the oxidation of the termination and shall only be opened prior to use.
- The products shall not be stored in areas where harmful gases containing sulfur or chlorine are present.