

PRELIMINARY SPEC

**Features**

- 3.2mmx1.6mm SMT LED, 0.75mm THICKNESS.
- LOW POWER CONSUMPTION.
- WIDE VIEWING ANGLE.
- IDEAL FOR BACKLIGHT AND INDICATOR.
- VARIOUS COLORS AND LENS TYPES AVAILABLE.
- PACKAGE : 2000PCS / REEL.
- MOISTURE SENSITIVITY LEVEL : LEVEL 3.
- RoHS COMPLIANT.

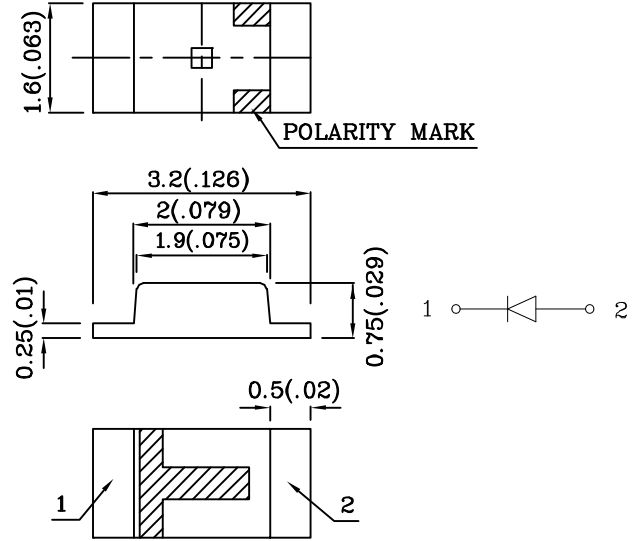

Notes:

1. All dimensions are in millimeters (inches).
2. Tolerance is  $\pm 0.2(0.008)$ " unless otherwise noted.
3. Specifications are subject to change without notice.

Absolute Maximum Ratings (TA=25°C)		M2BG (InGaN)	Unit
Reverse Voltage	VR	5	V
Forward Current	IF	30	mA
Forward Current (peak) 1/10 Duty Cycle 0.1ms Pulse Width	iFS	100	mA
Power Dissipation	PT	111	mW
Operating Temperature	TA	-40 ~ +85	°C
Storage Temperature	Tstg	-40 ~ +85	
Electrostatic Discharge Threshold (HBM)		1000	V

Operating Characteristics (TA=25°C)		M2BG (InGaN)	Unit
Forward Voltage (Typ.) (IF=20mA)	VF	3.2	V
Forward Voltage (Max.) (IF=20mA)	VF	3.7	V
Reverse Current (Max.) (VR=5V)	IR	10	uA
Wavelength Of Peak Emission (Typ.) (IF=20mA)	$\lambda P$	525	nm
Wavelength Of Dominant Emission (Typ.) (IF=20mA)	$\lambda D$	535	nm
Spectral Line Full Width At Half-Maximum (Typ.) (IF=20mA)	$\Delta\lambda$	39	nm
Capacitance (Typ.) (VF=0V, f=1MHz)	C	65	pF

Part Number	Emitting Color	Emitting Material	Lens-color	Luminous Intensity (IF=20mA)		Wavelength nm $\lambda P$	Viewing Angle 2 $\theta$ 1/2
				min.	typ.		
ZM2BG55W-1	Green	InGaN	Water Clear	380	795	525	120°

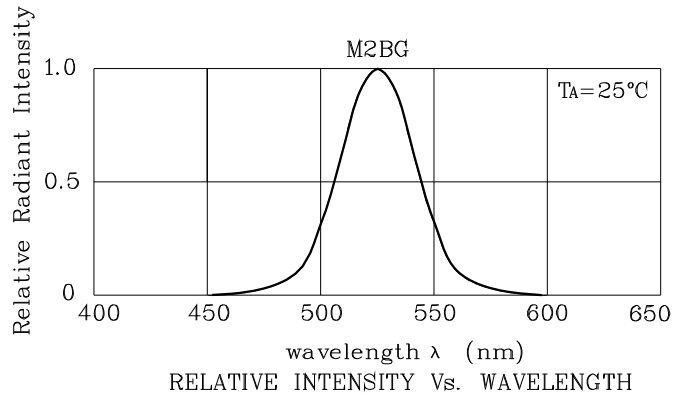

❖ M2BG

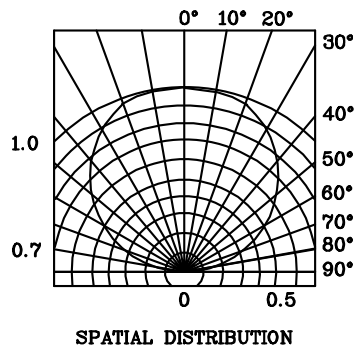
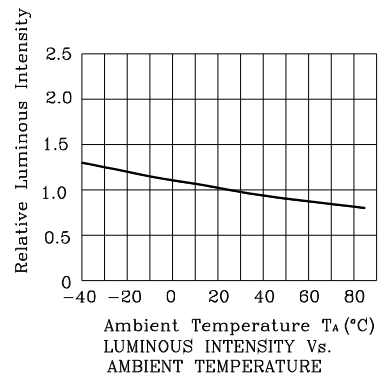
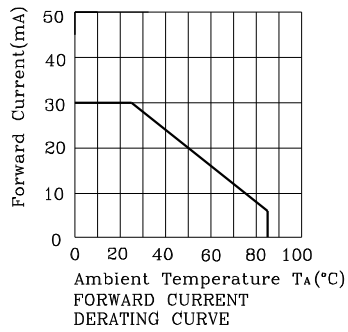
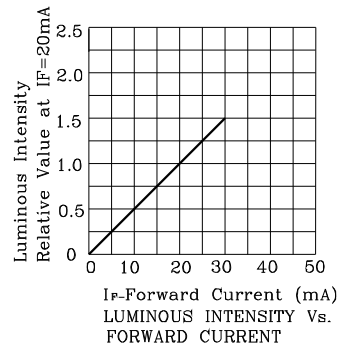
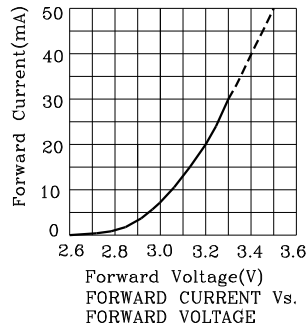

Reflow Soldering Profile For Lead-free SMT Process.

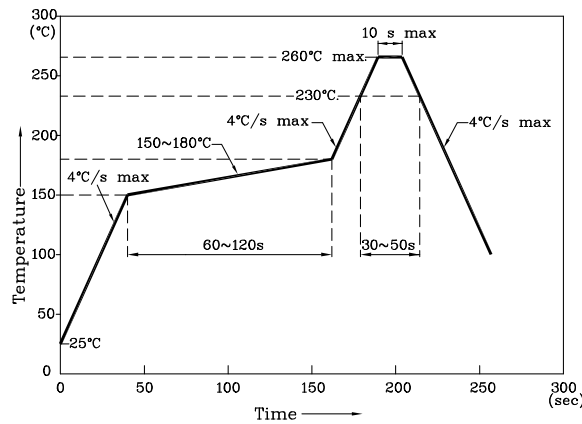

NOTES:

1. Maximum soldering temperature should not exceed 260°C.
2. Recommended reflow temperature: 145°C–260°C.
3. Do not put stress to the epoxy resin during high temperatures conditions.

❖ Recommended Soldering Pattern  
(Units : mm; Tolerance: ± 0.1)

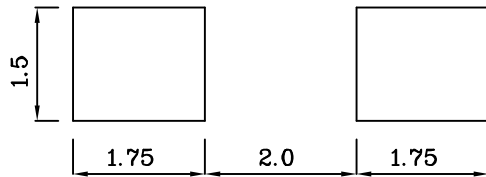

❖ The device has a single mounting surface. The device must be mounted according to the specifications.

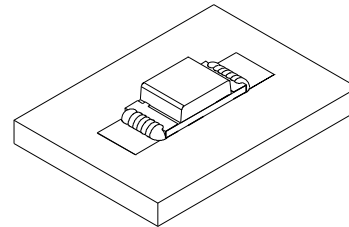

❖ Tape Specification (Units : mm)

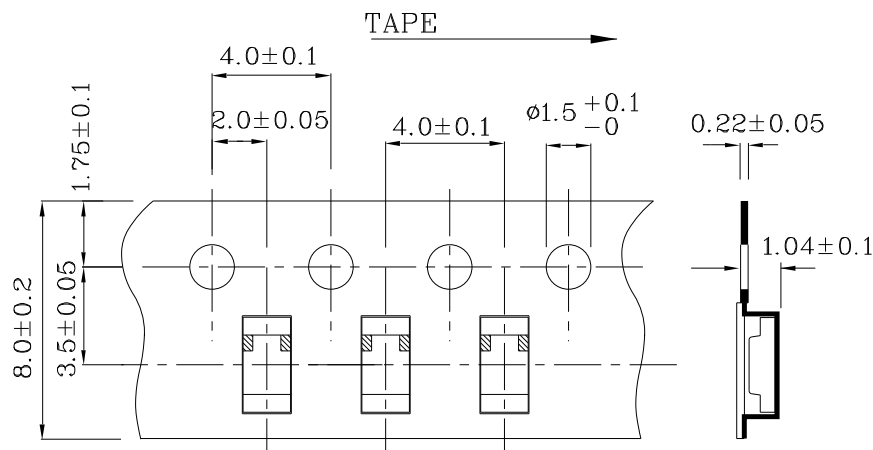

Remarks:



If special sorting is required (e.g. binning based on forward voltage, Luminous intensity / luminous flux, or wavelength), the typical accuracy of the sorting process is as follows:



1. Wavelength: +/-1nm
2. Luminous Intensity / Luminous Flux: +/-15%
3. Forward Voltage: +/-0.1V

Note: Accuracy may depend on the sorting parameters.

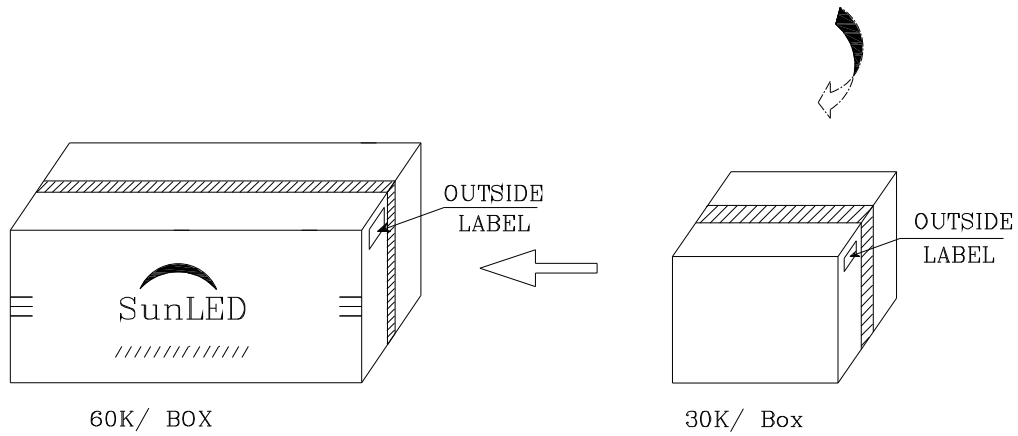
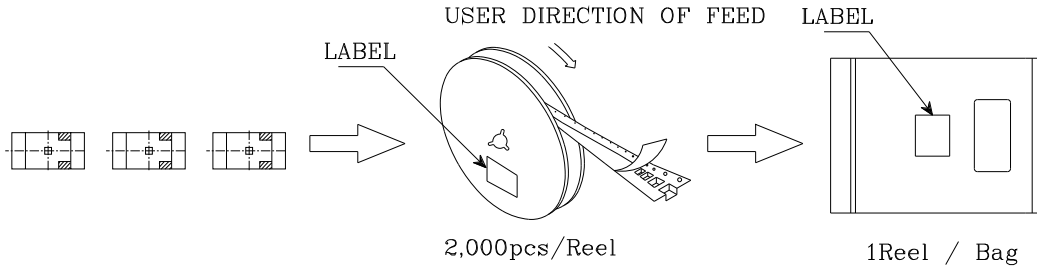
**PACKING & LABEL SPECIFICATIONS**

**ZM2BG55W-1**

	
P/NO : Zxxx55x-1	
QTY : 2,000 pcs	CODE: XXX
S/N : XX	
LOT NO:	
 xxxxxxxxxxxxxxxxxxxxxxxxx	
RoHS Compliant	