

## Data sheet | Item number: 792-801

Surge suppression module for signal technology; Nominal voltage: 24 VDC;  
for 2 signal paths with common surge arrester; for symmetric interfaces;  
Two-stage; Width: 6 mm; 2,50 mm<sup>2</sup>

[www.wago.com/792-801](http://www.wago.com/792-801)

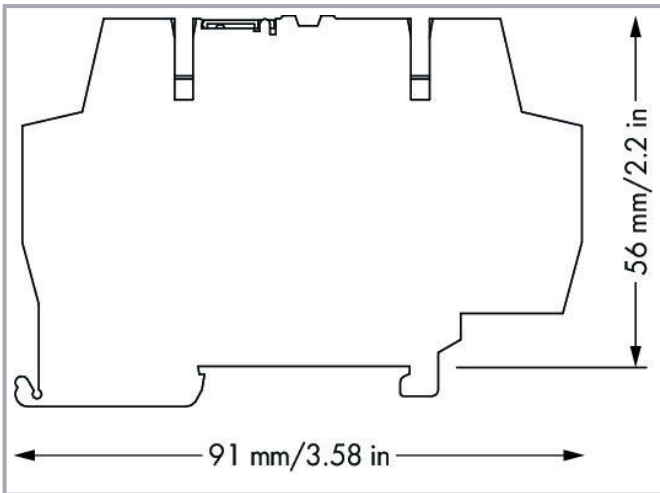
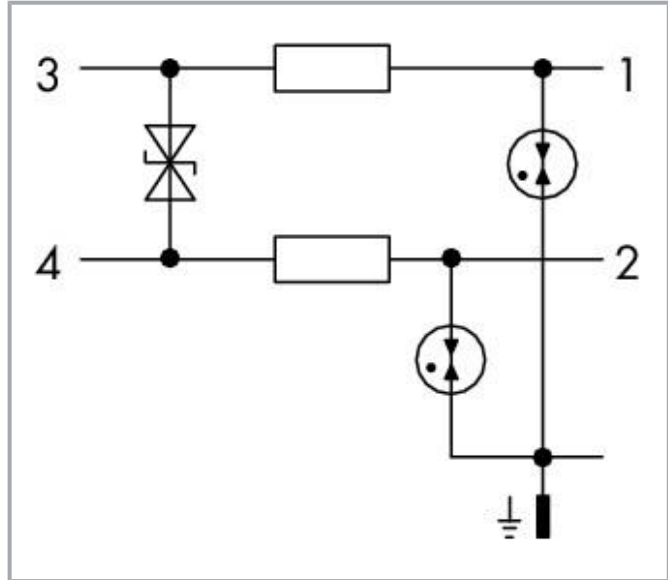
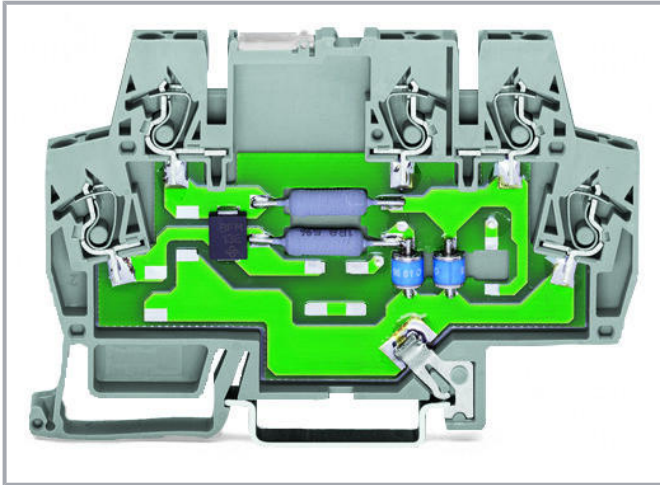

### Item description

#### Short description:

Provides surge protection for IT systems and devices in the voltage range up to 60 V (except custom solutions, e.g., telephone systems with ringing voltage).

Subject to changes. Please also observe the further product documentation!

WAGO GmbH & Co. KG  
Hansastr. 27  
32423 Minden  
Phone: +49571 887-0 | Fax: +49571 887-169  
Email: [info.de@wago.com](mailto:info.de@wago.com) | Web: [www.wago.com](http://www.wago.com)

Do you have any questions about our products?  
We are always happy to take your call at +49 (571) 887-44222.

Overvoltage protection is also possible for DIN-35 rail-mount terminal blocks. Multi-stage surge arresters in rail-mount terminal blocks (792-80x Series) of just 6 mm width ensure cost-effective protection for control and bus technology (e.g., LON<sup>®</sup> network, PROFIBUS network, binary signals).

#### Features:

- Protect your system against overvoltage
- Slim, space-saving design
- Control operational costs by preventing expensive, unplanned downtime
- High operational reliability and system uptime

#### Data

#### Notes

Note	The coordination characteristics of the surge arrester provide information about its discharge capacity and protection capability.
------	--

#### Electrical data

Nominal operating voltage	DC 24 V
Continuous operating voltage (max.)	AC 23 V / DC 33 V
Nominal current	0.5 A
Nominal discharge current (8/20 $\mu$ s), line	5 kA
Nominal discharge current (8/20 $\mu$ s) (total)	10 kA
Protection level (line/line) (cat. C2 at $I_N$ )	$\leq 50$ V
Protection level (line/protected ground) (cat. C2 at $I_N$ )	$\leq 750$ V
Protection level (line/line) (cat. C3 at $I_N$ )	$\leq 45$ V
Protection level (line/protected ground) (cat. C3 at $I_N$ )	$\leq 650$ V
Response time (line/line)	$\leq$
Response time (line/protected ground)	$\leq 100$ ns
Limit frequency (line/line)	6 MHz
Limit frequency (line/protected ground)	6 MHz
Impedance	1.8 $\Omega$
Capacitance (line/line)	$\leq 10$ nF
Capacitance (line/protected ground)	$\leq 5$ pF

Subject to changes. Please also observe the further product documentation!



## Safety and protection

Protection type	IP00
Protection class with end and intermediate plate	IP20

## Connection data

Connection points (number)	5
Connection technology	CAGE CLAMP®
Solid conductor	0.08 ... 2.5 mm <sup>2</sup> / 28 ... 14 AWG
Fine-stranded conductor	0.08 ... 2.5 mm <sup>2</sup> / 28 ... 14 AWG
Strip length	5 ... 6 mm / 0.2 ... 0.24 inch

## Physical data

Width	6 mm / 0.236 inch
Height from upper-edge of DIN-rail	56 mm / 2.205 inch
Depth	91 mm / 3.583 inch

## Mechanical data

Mounting type	DIN-35 rail
---------------	-------------

## Material data

Weight	38.7 g
--------	--------

## Environmental requirements

Surrounding air temperature (operation)	-40 ... 80 °C
Surrounding air temperature (storage)	-40 ... 80 °C

## Standards and specifications

Standards/Specifications	IEC 61643-21
--------------------------	--------------

## Commercial data

Product Group	21 (Special Products Electronic)
PU (SPU)	1 Stück
Packaging type	box
Country of origin	DE

Subject to changes. Please also observe the further product documentation!

GTIN	4017332780742
Customs tariff number	85363010900

## Optional accessories









### Tool

Operating tool		
	<b>Item no.: 210-720</b> Operating tool; Blade: 3.5 x 0.5 mm; with a partially insulated shaft; multicoloured	<a href="http://www.wago.com/210-720">www.wago.com/210-720</a>

### End plate

Intermediate plate		
	<b>Item no.: 859-525</b> End and intermediate plate; 1 mm thick; gray	<a href="http://www.wago.com/859-525">www.wago.com/859-525</a>

### Jumpers

Jumper		
	<b>Item no.: 859-408</b> Jumper; for jumper slot; 8-way; insulated; light gray	<a href="http://www.wago.com/859-408">www.wago.com/859-408</a>
	<b>Item no.: 859-404/000-005</b> Jumper; for jumper slot; 4-way; insulated; red	<a href="http://www.wago.com/859-404/000-005">www.wago.com/859-404/000-005</a>
	<b>Item no.: 859-404/000-006</b> Jumper; for jumper slot; 4-way; insulated; blue	<a href="http://www.wago.com/859-404/000-006">www.wago.com/859-404/000-006</a>
	<b>Item no.: 859-405/000-005</b> Jumper; for jumper slot; 5-way; insulated; red	<a href="http://www.wago.com/859-405/000-005">www.wago.com/859-405/000-005</a>
	<b>Item no.: 859-405/000-029</b> Jumper; for jumper slot; 5-way; insulated; yellow	<a href="http://www.wago.com/859-405/000-029">www.wago.com/859-405/000-029</a>
	<b>Item no.: 859-405</b> Jumper; for jumper slot; 5-way; insulated; light gray	<a href="http://www.wago.com/859-405">www.wago.com/859-405</a>
	<b>Item no.: 859-404/000-029</b> Jumper; for jumper slot; 4-way; insulated; yellow	<a href="http://www.wago.com/859-404/000-029">www.wago.com/859-404/000-029</a>
	<b>Item no.: 859-406</b> Jumper; for jumper slot; 6-way; insulated; light gray	<a href="http://www.wago.com/859-406">www.wago.com/859-406</a>

Subject to changes. Please also observe the further product documentation!



**Item no.: 859-405/000-006**  
Jumper; for jumper slot; 5-way; insulated; blue

[www.wago.com/859-405/000-006](http://www.wago.com/859-405/000-006)



**Item no.: 859-406/000-005**  
Jumper; for jumper slot; 6-way; insulated; red

[www.wago.com/859-406/000-005](http://www.wago.com/859-406/000-005)



**Item no.: 859-409/000-029**  
Jumper; for jumper slot; 9-way; insulated; yellow

[www.wago.com/859-409/000-029](http://www.wago.com/859-409/000-029)



**Item no.: 859-410/000-005**  
Jumper; for jumper slot; 10-way; insulated; red

[www.wago.com/859-410/000-005](http://www.wago.com/859-410/000-005)



**Item no.: 859-410/000-029**  
Jumper; for jumper slot; 10-way; insulated; yellow

[www.wago.com/859-410/000-029](http://www.wago.com/859-410/000-029)



**Item no.: 859-410**  
Jumper; for jumper slot; 10-way; insulated; light gray

[www.wago.com/859-410](http://www.wago.com/859-410)

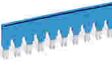

**Item no.: 859-410/000-006**  
Jumper; for jumper slot; 10-way; insulated; blue

[www.wago.com/859-410/000-006](http://www.wago.com/859-410/000-006)



**Item no.: 859-403/000-005**  
Jumper; for jumper slot; 3-way; insulated; red

[www.wago.com/859-403/000-005](http://www.wago.com/859-403/000-005)



**Item no.: 859-402/000-029**  
Jumper; for jumper slot; 2-way; insulated; yellow

[www.wago.com/859-402/000-029](http://www.wago.com/859-402/000-029)



**Item no.: 859-403/000-029**  
Jumper; for jumper slot; 3-way; insulated; yellow

[www.wago.com/859-403/000-029](http://www.wago.com/859-403/000-029)



**Item no.: 859-403/000-006**  
Jumper; for jumper slot; 3-way; insulated; blue

[www.wago.com/859-403/000-006](http://www.wago.com/859-403/000-006)



**Item no.: 859-408/000-005**  
Jumper; for jumper slot; 8-way; insulated; red

[www.wago.com/859-408/000-005](http://www.wago.com/859-408/000-005)



**Item no.: 859-408/000-029**  
Jumper; for jumper slot; 8-way; insulated; yellow















[www.wago.com/859-408/000-029](http://www.wago.com/859-408/000-029)



**Item no.: 859-409**  
Jumper; for jumper slot; 9-way; insulated; light gray











[www.wago.com/859-409](http://www.wago.com/859-409)

Subject to changes. Please also observe the further product documentation!

	<b>Item no.: 859-408/000-006</b> Jumper; for jumper slot; 8-way; insulated; blue	<a href="http://www.wago.com/859-408/000-006">www.wago.com/859-408/000-006</a>
	<b>Item no.: 859-403</b> Jumper; for jumper slot; 3-way; insulated; light gray	<a href="http://www.wago.com/859-403">www.wago.com/859-403</a>
	<b>Item no.: 859-409/000-005</b> Jumper; for jumper slot; 9-way; insulated; red	<a href="http://www.wago.com/859-409/000-005">www.wago.com/859-409/000-005</a>
	<b>Item no.: 859-404</b> Jumper; for jumper slot; 4-way; insulated; light gray	<a href="http://www.wago.com/859-404">www.wago.com/859-404</a>
	<b>Item no.: 859-409/000-006</b> Jumper; for jumper slot; 9-way; insulated; blue	<a href="http://www.wago.com/859-409/000-006">www.wago.com/859-409/000-006</a>
	<b>Item no.: 859-402/000-006</b> Jumper; for jumper slot; 2-way; insulated; blue	<a href="http://www.wago.com/859-402/000-006">www.wago.com/859-402/000-006</a>
	<b>Item no.: 859-402</b> Jumper; for jumper slot; 2-way; insulated; light gray	<a href="http://www.wago.com/859-402">www.wago.com/859-402</a>
	<b>Item no.: 859-402/000-005</b> Jumper; for jumper slot; 2-way; insulated; red	<a href="http://www.wago.com/859-402/000-005">www.wago.com/859-402/000-005</a>
	<b>Item no.: 859-406/000-006</b> Jumper; for jumper slot; 6-way; insulated; blue	<a href="http://www.wago.com/859-406/000-006">www.wago.com/859-406/000-006</a>
	<b>Item no.: 859-406/000-029</b> Jumper; for jumper slot; 6-way; insulated; signal yellow	<a href="http://www.wago.com/859-406/000-029">www.wago.com/859-406/000-029</a>
	<b>Item no.: 859-407/000-006</b> Jumper; for jumper slot; 7-way; insulated; blue	<a href="http://www.wago.com/859-407/000-006">www.wago.com/859-407/000-006</a>
	<b>Item no.: 859-407/000-005</b> Jumper; for jumper slot; 7-way; insulated; red	<a href="http://www.wago.com/859-407/000-005">www.wago.com/859-407/000-005</a>
	<b>Item no.: 859-407/000-029</b> Jumper; for jumper slot; 7-way; insulated; yellow	<a href="http://www.wago.com/859-407/000-029">www.wago.com/859-407/000-029</a>
	<b>Item no.: 859-407</b> Jumper; for jumper slot; 7-way; insulated; light gray	<a href="http://www.wago.com/859-407">www.wago.com/859-407</a>

Subject to changes. Please also observe the further product documentation!

## Marking accessories

Marking device		
	<b>Item no.: 210-110</b> Fiber-tip pen	<a href="http://www.wago.com/210-110">www.wago.com/210-110</a>
Marker		
	<b>Item no.: 2009-145</b> Mini-WSB Inline; for Smart Printer; 1700 pieces on roll; stretchable 5 - 5.2 mm; plain; snap-on type; white	<a href="http://www.wago.com/2009-145">www.wago.com/2009-145</a>
	<b>Item no.: 248-451</b> Mini-WSB marking card; as card; MARKED; K11 - K20 (10x); not stretchable; Horizontal marking; snap-on type; white	<a href="http://www.wago.com/248-451">www.wago.com/248-451</a>
	<b>Item no.: 248-455</b> Mini-WSB marking card; as card; MARKED; U 100 (10x); not stretchable; Horizontal marking; snap-on type; white	<a href="http://www.wago.com/248-455">www.wago.com/248-455</a>
	<b>Item no.: 248-450</b> Mini-WSB marking card; as card; MARKED; K1 - K10 (10x); not stretchable; Horizontal marking; snap-on type; white	<a href="http://www.wago.com/248-450">www.wago.com/248-450</a>
	<b>Item no.: 248-452</b> Mini-WSB marking card; as card; MARKED; K (100x); not stretchable; Horizontal marking; snap-on type; white	<a href="http://www.wago.com/248-452">www.wago.com/248-452</a>
	<b>Item no.: 248-453</b> Mini-WSB marking card; as card; MARKED; U1, ... U10 (10x); not stretchable; Horizontal marking; snap-on type; white	<a href="http://www.wago.com/248-453">www.wago.com/248-453</a>
	<b>Item no.: 248-454</b> Mini-WSB marking card; as card; MARKED; U11 - U20 (10x); not stretchable; Horizontal marking; snap-on type; white	<a href="http://www.wago.com/248-454">www.wago.com/248-454</a>
	<b>Item no.: 248-566</b> Mini-WSB marking card; as card; MARKED; 1 ... 50 (2x); not stretchable; Horizontal marking; snap-on type; white	<a href="http://www.wago.com/248-566">www.wago.com/248-566</a>
	<b>Item no.: 248-501</b> Mini-WSB marking card; as card; not stretchable; plain; snap-on type; white	<a href="http://www.wago.com/248-501">www.wago.com/248-501</a>
	<b>Item no.: 248-504</b> Mini-WSB marking card; as card; MARKED; 21 ... 30 (10x); not stretchable; Horizontal marking; snap-on type; white	<a href="http://www.wago.com/248-504">www.wago.com/248-504</a>

## Downloads

### Documentation

#### Bid Text

792-801	2019. 2. 19.	xml	Download
X81 - Datei		4.6 kB	
792-801	2015. 2. 11.	doc	Download

Subject to changes. Please also observe the further product documentation!

WAGO GmbH & Co. KG  
 Hansastr. 27  
 32423 Minden  
 Phone: +49571 887-0 | Fax: +49571 887-169  
 Email: [info.de@wago.com](mailto:info.de@wago.com) | Web: [www.wago.com](http://www.wago.com)

Do you have any questions about our products?  
 We are always happy to take your call at +49 (571) 887-44222.



doc - Datei

27.1 kB

#### Additional Information

Disposal; Electrical and electronic equipment, Packaging

V 1.0.0

pdf  
265.8 kB

Download

#### CAD/CAE-Data

##### CAE data

EPLAN Data Portal 792-801

URL

Download

WSCAD Universe 792-801

URL

Download

ZUKEN Portal 792-801

URL

Download

##### CAD data

2D/3D Models 792-801

URL

Download

#### Environmental Product Compliance

##### Compliance Search

Environmental Product Compliance 792-801

URL

Download

Surge suppression module for signal technology; Nominal voltage: 24 VDC; for 2 signal paths with common surge arrester; for symmetric interfaces; Two-stage; Width: 6 mm; 2,50 mm<sup>2</sup>

#### Installation Notes

Subject to changes. Please also observe the further product documentation!

WAGO GmbH & Co. KG

Hansastr. 27

32423 Minden

Phone: +49571 887-0 | Fax: +49571 887-169

Email: [info.de@wago.com](mailto:info.de@wago.com) | Web: [www.wago.com](http://www.wago.com)

Do you have any questions about our products?

We are always happy to take your call at +49 (571) 887-44222.