

# PAA50F

PAA 50 F -5 -□

① ② ③ ④ ⑤

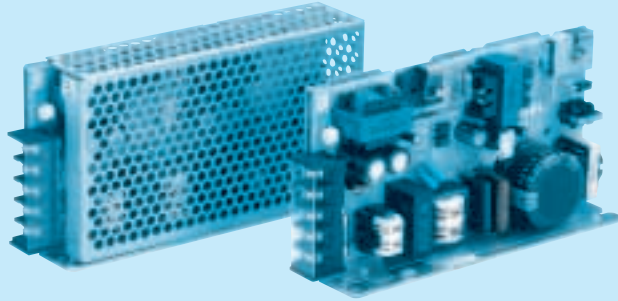

Recommended EMI/EMC Filter  
NAC-06-472



High voltage pulse noise type : NAP series  
Low leakage current type : NAM series  
\*The EMI/EMC Filter is recommended to connect with several devices.

- ① Series name
- ② Output wattage
- ③ Universal input
- ④ Output voltage
- ⑤ Optional \*4
- C :with Coating
- G :Low leakage current
- J :Connector type
- N :with Cover
- R :with Remote ON/OFF

MODEL	PAA50F-3	PAA50F-5	PAA50F-12	PAA50F-15	PAA50F-24	PAA50F-48
MAX OUTPUT WATTAGE[W]	30	50	51.6	52.5	52.8	52.8
DC OUTPUT	3V 10A	5V 10A	12V 4.3A	15V 3.5A	24V 2.2A	48V 1.1A

## SPECIFICATIONS

	MODEL	PAA50F-3	PAA50F-5	PAA50F-12	PAA50F-15	PAA50F-24	PAA50F-48	
INPUT	VOLTAGE[V]	AC85 - 264 1 φ						
	CURRENT[A]	ACIN 100V	0.5typ	0.8typ				
		ACIN 200V	0.25typ	0.4typ				
	FREQUENCY[Hz]	50/60 (47 - 63)						
	EFFICIENCY[%]	67typ	74typ	77typ	78typ	80typ	80typ	
	POWER FACTOR	ACIN 100V	0.95typ (Io=100%)					
		ACIN 200V	15typ (Io=100%)					
	INRUSH CURRENT[A]	ACIN 100V	15typ (Io=100%)					
ACIN 200V		15typ (Io=100%)						
LEAKAGE CURRENT[ma]	0.75max (60Hz, According to UL, CSA, VDE and DEN-AN)							
OUTPUT	VOLTAGE[V]	3	5	12	15	24	48	
	CURRENT[A]	10	10	4.3	3.5	2.2	1.1	
	LINE REGULATION[mV]	20max	20max	48max	60max	96max	192max	
	LOAD REGULATION[mV]	40max	40max	100max	120max	150max	240max	
	RIPPLE[mVp-p]	0 to +50°C *1	80max	80max	120max	120max	120max	150max
		-10 - 0°C *1	140max	140max	160max	160max	160max	200max
	RIPPLE NOISE[mVp-p]	0 to +50°C *1	120max	120max	150max	150max	150max	250max
		-10 - 0°C *1	160max	160max	180max	180max	180max	300max
	TEMPERATURE REGULATION[mV]	0 to +50°C	50max	50max	120max	150max	240max	480max
		-10 to +50°C	60max	60max	150max	180max	290max	600max
	DRIFT[mV]	20max	20max	48max	60max	96max	192max	
START-UP TIME[ms]	500max (ACIN 85V, Io=100%)							
HOLD-UP TIME[ms]	10typ (ACIN 85V, Io=100%) 20typ (ACIN 100V, Io=100%) 100typ (ACIN 200V, Io=100%)							
OUTPUT VOLTAGE ADJUSTMENT RANGE[V]	2.85 - 3.6	±10%						
PROTECTION CIRCUIT AND OTHERS	OVERCURRENT PROTECTION	Works over 105% of rating and recovers automatically						
	OVERVOLTAGE PROTECTION	4.00 - 5.25V	Works at 115 - 140% of rating					
	OPERATING INDICATION	LED (Green)						
	REMOTE ON/OFF	Optional (Refer to Instruction Manual)						
ISOLATION	INPUT-OUTPUT · RC	*3 AC3.000V 1minute, Cutoff current = 10mA, DC500V 50MΩ min (At Room Temperature)						
	INPUT-FG	AC2.000V 1minute, Cutoff current = 10mA, DC500V 50MΩ min (At Room Temperature)						
	OUTPUT · RC-FG	*3 AC500V 1minute, Cutoff current = 100mA, DC500V 50MΩ min (At Room Temperature)						
	OUTPUT-RC	*3 AC100V 1minute, Cutoff current = 100mA, DC100V 10MΩ min (At Room Temperature)						
ENVIRONMENT	OPERATING TEMP., HUMID. AND ALTITUDE	-10 to +65°C, 20 - 90%RH (Non condensing) (Refer to DERATING CURVE), 3,000m (10,000feet) max						
	STORAGE TEMP., HUMID. AND ALTITUDE	-20 to +75°C, 20 - 90%RH (Non condensing), 9,000m (30,000feet) max						
	VIBRATION	10 - 55Hz, 19.6m/s <sup>2</sup> (2G), 3minutes period, 60minutes each along X, Y and Z axis						
	IMPACT	196.1m/s <sup>2</sup> (20G), 11ms, once each X, Y and Z axis						
SAFETY AND NOISE REGULATIONS	AGENCY APPROVALS	UL60950-1, EN60950-1, EN50178, CSA C22.2 No.60950-1 Complies with DEN-AN and IEC60950-1						
	CONDUCTED NOISE	Complies with FCC-B, CISPR22-B, EN55022-B, VCCI-B						
	HARMONIC ATTENUATOR	Complies with IEC61000-3-2						
OTHERS	CASE SIZE/WEIGHT	37×85×159mm (without terminal block) (W×H×D) /400g max (without cover)						
	COOLING METHOD	Convection						

\*1 According to 20MHz oscilloscope or Ripple-Noise meter (equivalent to KEISOKU-GIKEN : RM101).  
 \*2 Drift is change in DC output for an eight hour period after a half-hour warm-up at 25°C, with the input voltage held constant at the rated input/output.  
 \*3 Applicable when Remote ON/OFF (optional) is added.  
 \*4 Please contact us about safety approvals for the model with option.  
 \* Derating is required when operated with case cover.

External view

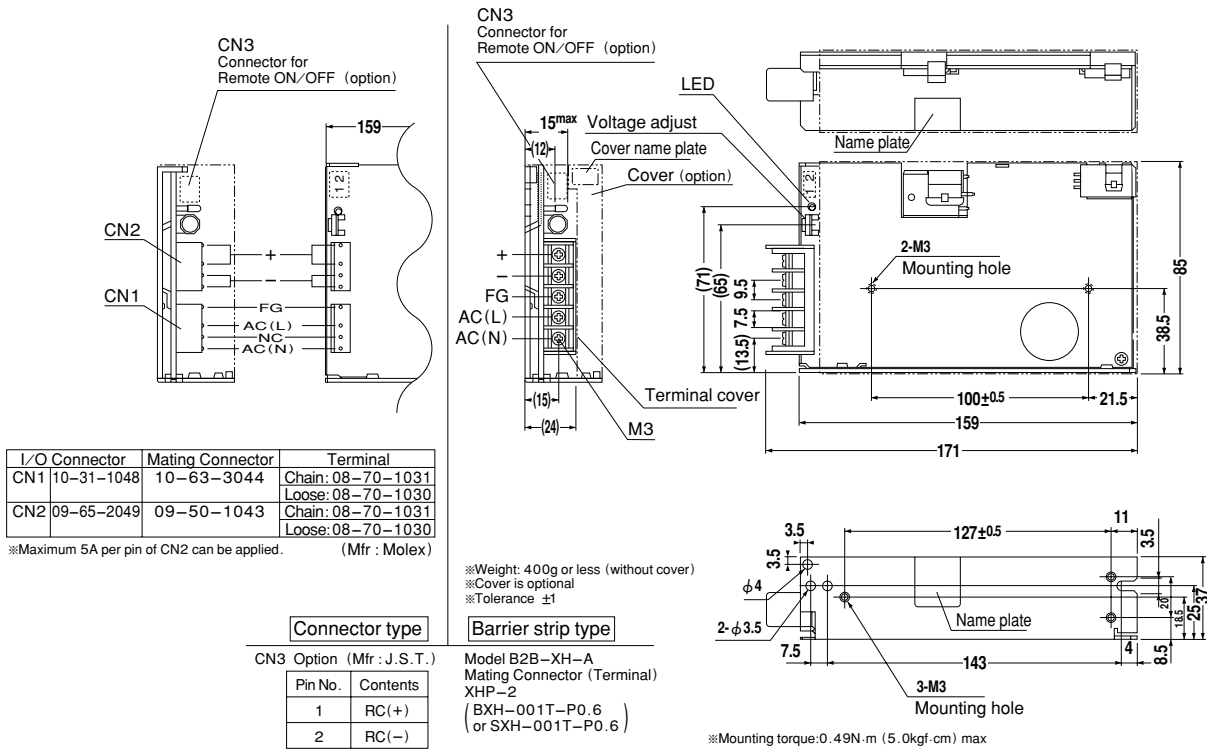

Performance data

RISE TIME & FALL TIME (PAA50F-5)

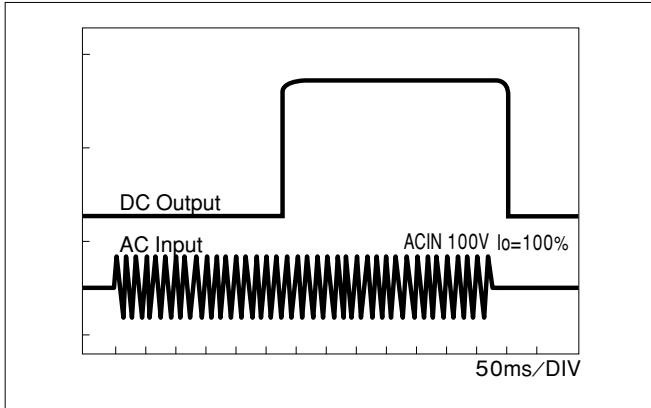

EFFICIENCY (PAA50F-5)

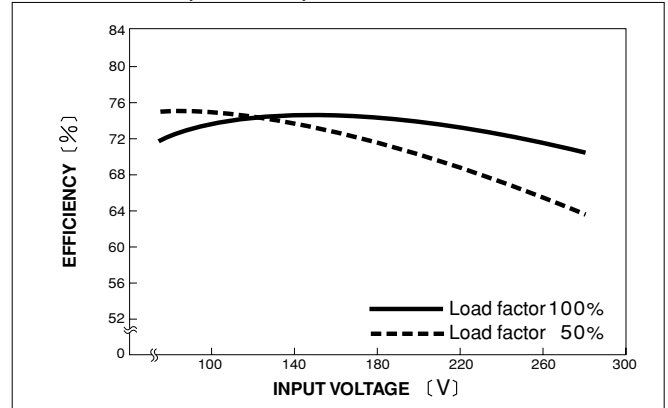

HARMONIC CURRENT (PAA50F-5)

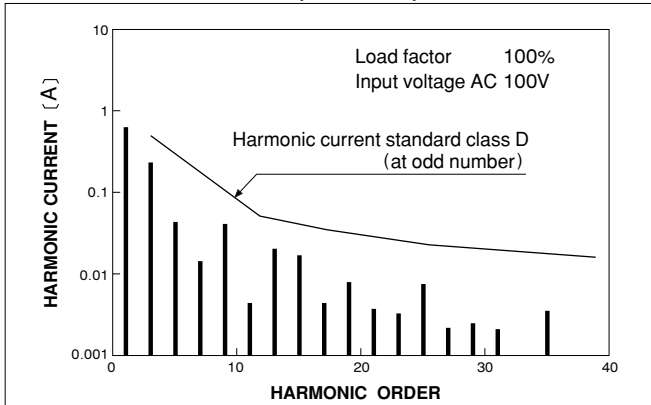

HARMONIC CURRENT (PAA50F-5)

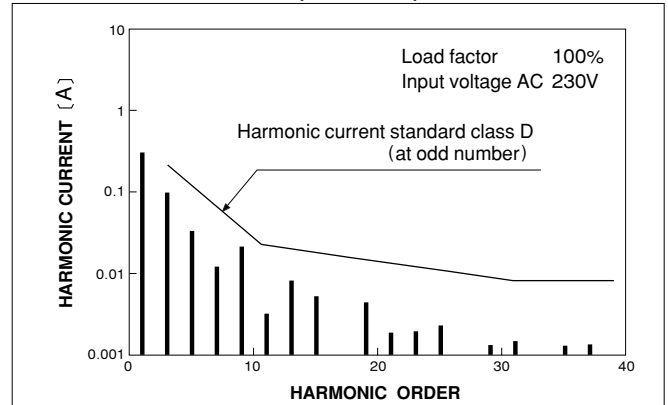

# PAA75F

PAA 75 F -5 -□

① ② ③ ④ ⑤

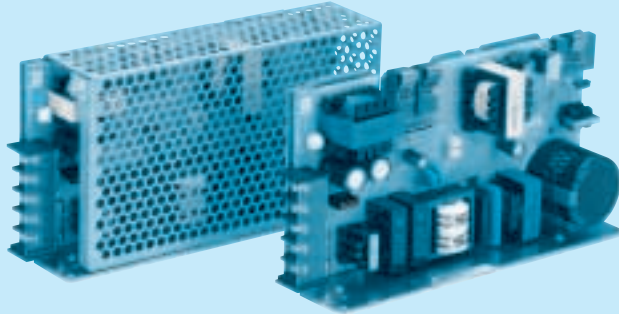

Recommended EMI/EMC Filter  
NAC-06-472



High voltage pulse noise type : NAP series  
Low leakage current type : NAM series  
\*The EMI/EMC Filter is recommended to connect with several devices.

- ① Series name
- ② Output wattage
- ③ Universal input
- ④ Output voltage
- ⑤ Optional \*4
- C :with Coating
- G :Low leakage current
- J :Connector type
- N :with Cover
- R :with Remote ON/OFF

MODEL	PAA75F-3	PAA75F-5	PAA75F-12	PAA75F-15	PAA75F-24	PAA75F-48
MAX OUTPUT WATTAGE[W]	45	75	75.6	75	76.8	76.8
DC OUTPUT	3V 15A	5V 15A	12V 6.3A	15V 5A	24V 3.2A	48V 1.6A

## SPECIFICATIONS

	MODEL	PAA75F-3	PAA75F-5	PAA75F-12	PAA75F-15	PAA75F-24	PAA75F-48	
INPUT	VOLTAGE[V]	AC85 - 264 1 φ						
	CURRENT[A]	ACIN 100V	0.7typ	1.2typ				
		ACIN 200V	0.35typ	0.6typ				
	FREQUENCY[Hz]	50/60 (47 - 63)						
	EFFICIENCY[%]	67typ	74typ	77typ	78typ	80typ	80typ	
	POWER FACTOR	ACIN 100V	0.95typ (Io=100%)					
		ACIN 200V	15typ (Io=100%)					
	INRUSH CURRENT[A]	ACIN 100V	15typ (Io=100%)					
ACIN 200V		15typ (Io=100%)						
LEAKAGE CURRENT[ma]	0.75max (60Hz, According to UL, CSA, VDE and DEN-AN)							
OUTPUT	VOLTAGE[V]	3	5	12	15	24	48	
	CURRENT[A]	15	15	6.3	5	3.2	1.6	
	LINE REGULATION[mV]	20max	20max	48max	60max	96max	192max	
	LOAD REGULATION[mV]	40max	40max	100max	120max	150max	240max	
	RIPPLE[mVp-p]	0 to +50°C *1	80max	80max	120max	120max	120max	150max
		-10 - 0°C *1	140max	140max	160max	160max	160max	200max
	RIPPLE NOISE[mVp-p]	0 to +50°C *1	120max	120max	150max	150max	150max	250max
		-10 - 0°C *1	160max	160max	180max	180max	180max	300max
	TEMPERATURE REGULATION[mV]	0 to +50°C	50max	50max	120max	150max	240max	480max
		-10 to +50°C	60max	60max	150max	180max	290max	600max
	DRIFT[mV]	20max	20max	48max	60max	96max	192max	
START-UP TIME[ms]	500max (ACIN 85V, Io=100%)							
HOLD-UP TIME[ms]	10typ (ACIN 85V, Io=100%) 20typ (ACIN 100V, Io=100%) 100typ (ACIN 200V, Io=100%)							
OUTPUT VOLTAGE ADJUSTMENT RANGE[V]	2.85 - 3.6	±10%						
PROTECTION CIRCUIT AND OTHERS	OVERCURRENT PROTECTION	Works over 105% of rating and recovers automatically						
	OVERVOLTAGE PROTECTION	4.00 - 5.25V	Works at 115 - 140% of rating					
	OPERATING INDICATION	LED (Green)						
	REMOTE ON/OFF	Optional (Refer to Instruction Manual)						
ISOLATION	INPUT-OUTPUT · RC	*3 AC3.000V 1minute, Cutoff current = 10mA, DC500V 50MΩ min (At Room Temperature)						
	INPUT-FG	AC2.000V 1minute, Cutoff current = 10mA, DC500V 50MΩ min (At Room Temperature)						
	OUTPUT · RC-FG	*3 AC500V 1minute, Cutoff current = 100mA, DC500V 50MΩ min (At Room Temperature)						
	OUTPUT-RC	*3 AC100V 1minute, Cutoff current = 100mA, DC100V 10MΩ min (At Room Temperature)						
ENVIRONMENT	OPERATING TEMP., HUMID. AND ALTITUDE	-10 to +65°C, 20 - 90%RH (Non condensing) (Refer to DERATING CURVE), 3,000m (10,000feet) max						
	STORAGE TEMP., HUMID. AND ALTITUDE	-20 to +75°C, 20 - 90%RH (Non condensing), 9,000m (30,000feet) max						
	VIBRATION	10 - 55Hz, 19.6m/s <sup>2</sup> (2G), 3minutes period, 60minutes each along X, Y and Z axis						
	IMPACT	196.1m/s <sup>2</sup> (20G), 11ms, once each X, Y and Z axis						
SAFETY AND NOISE REGULATIONS	AGENCY APPROVALS	UL60950-1, EN60950-1, EN50178, CSA C22.2 No.60950-1 Complies with DEN-AN and IEC60950-1						
	CONDUCTED NOISE	Complies with FCC-B, CISPR22-B, EN55022-B, VCCI-B						
	HARMONIC ATTENUATOR	Complies with IEC61000-3-2						
OTHERS	CASE SIZE/WEIGHT	42×93×175mm (without terminal block) (W×H×D) /550g max (without cover)						
	COOLING METHOD	Convection						

\*1 According to 20MHz oscilloscope or Ripple-Noise meter (equivalent to KEISOKU-GIKEN : RM101).

\*2 Drift is change in DC output for an eight hour period after a half-hour warm-up at 25°C, with the input voltage held constant at the rated input/output.

\*3 Applicable when Remote ON/OFF (optional) is added.

\*4 Please contact us about safety approvals for the model with option.

\* Derating is required when operated with case cover.

External view

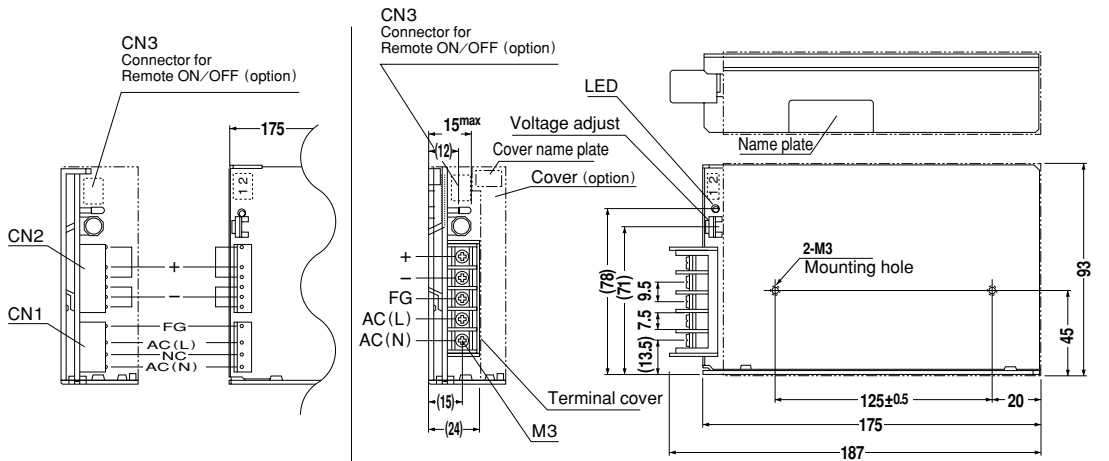

I/O Connector	Mating Connector	Terminal
CN1 10-31-1048	10-63-3044	Chain: 08-70-1031 Loose: 08-70-1030
CN2 09-65-2069	09-50-1063	Chain: 08-70-1031 Loose: 08-70-1030

※Maximum 5A per pin of CN2 can be applied. (Mfr : Molex)

※Weight: 500g or less (without cover)  
※Cover is optional  
※Tolerance± 1

Connector type

CN3 Option (Mfr : J.S.T.)

Pin No.	Contents
1	RC(+)
2	RC(-)

Barrier strip type

Model B2B-XH-A  
Mating Connector (Terminal)  
XHP-2  
(BXH-001T-P0.6  
or SXH-001T-P0.6)

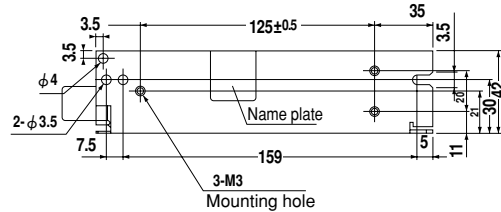

※Mounting torque: 0.49N·m (5.0kgf·cm) max

Performance data

RISE TIME & FALL TIME (PAA75F-5)

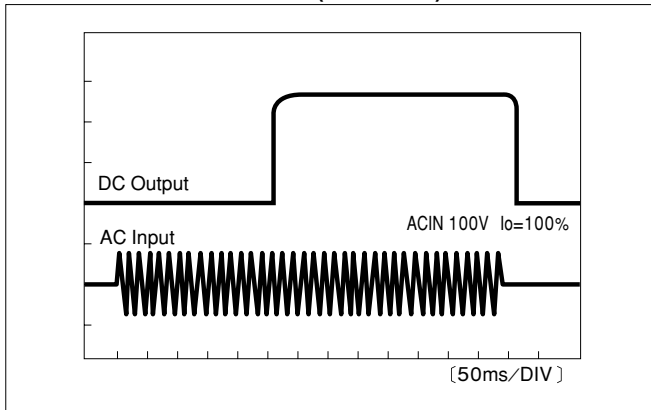

EFFICIENCY (PAA75F-5)

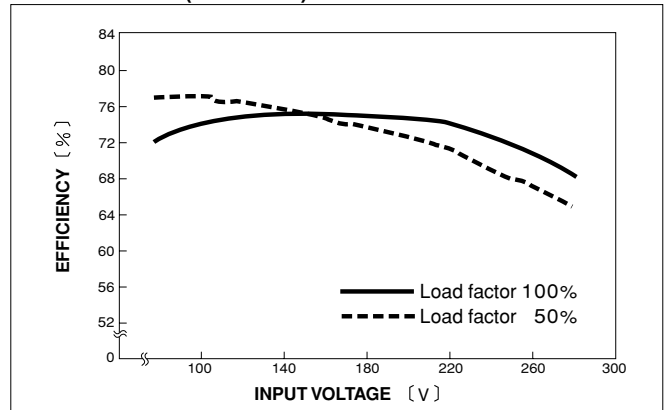

HARMONIC CURRENT (PAA75F-5)

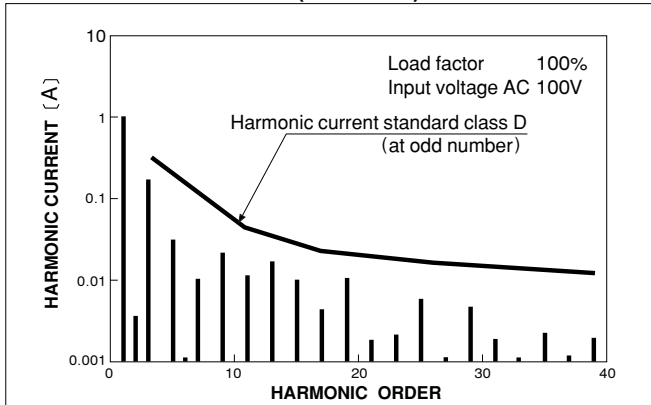

HARMONIC CURRENT (PAA75F-5)

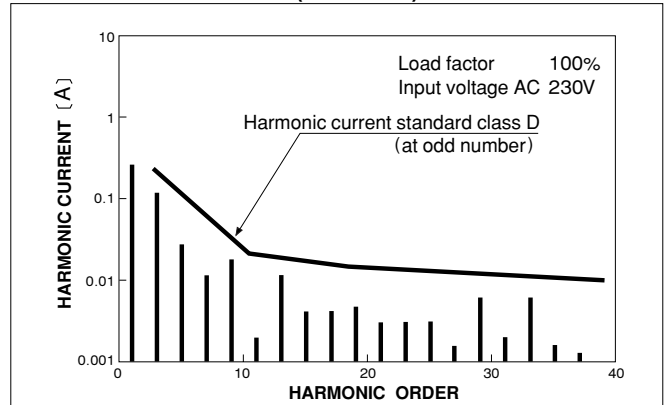

# PAA100F

PAA 100 F -5 -□

① ② ③ ④ ⑤

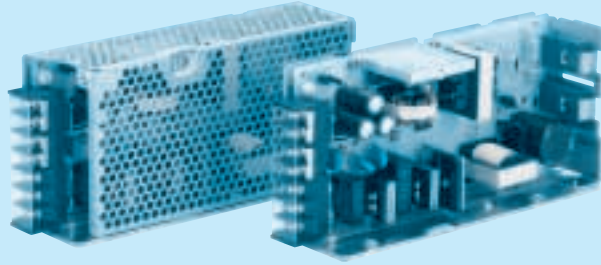

Recommended EMI/EMC Filter  
NAC-06-472



High voltage pulse noise type : NAP series  
Low leakage current type : NAM series  
\*The EMI/EMC Filter is recommended to connect with several devices.

- ① Series name
- ② Output wattage
- ③ Universal input
- ④ Output voltage
- ⑤ Optional \*4
- C :with Coating
- G :Low leakage current
- N :with Cover
- R :with Remote ON/OFF

MODEL	PAA100F-3	PAA100F-5	PAA100F-12	PAA100F-15	PAA100F-24	PAA100F-48
MAX OUTPUT WATTAGE[W]	60	100	102	105	108	100.8
DC OUTPUT	3V 20A	5V 20A	12V 8.5A	15V 7A	24V 4.5A	48V 2.1A

## SPECIFICATIONS

	MODEL	PAA100F-3	PAA100F-5	PAA100F-12	PAA100F-15	PAA100F-24	PAA100F-48	
INPUT	VOLTAGE[V]	AC85 - 264 1 φ or DC120 - 340						
	CURRENT[A]	ACIN 100V	0.9typ	1.4typ				
		ACIN 200V	0.45typ	0.7typ				
	FREQUENCY[Hz]	50/60 (47 - 63)						
	EFFICIENCY[%]	65typ	74typ	76typ	77typ	79typ	79typ	
	POWER FACTOR	ACIN 100V	0.99typ (Io=100%)					
		ACIN 200V	0.95typ (Io=100%)					
	INRUSH CURRENT[A]	ACIN 100V	20typ (Io=100%) (At cold start)					
ACIN 200V		40typ (Io=100%) (At cold start)						
LEAKAGE CURRENT[ma]	0.75max (60Hz, According to UL, CSA, VDE and DEN-AN)							
OUTPUT	VOLTAGE[V]	3	5	12	15	24	48	
	CURRENT[A]	20	20	8.5	7	4.5	2.1	
	LINE REGULATION[mV]	20max	20max	48max	60max	96max	192max	
	LOAD REGULATION[mV]	40max	40max	100max	120max	150max	240max	
	RIPPLE[mVp-p]	0 to +50°C *1	80max	80max	120max	120max	120max	150max
		-10 - 0°C *1	140max	140max	160max	160max	160max	200max
	RIPPLE NOISE[mVp-p]	0 to +50°C *1	120max	120max	150max	150max	150max	400max
		-10 - 0°C *1	160max	160max	180max	180max	180max	600max
	TEMPERATURE REGULATION[mV]	0 to +50°C	50max	50max	120max	150max	240max	480max
		-10 to +50°C	60max	60max	150max	180max	290max	600max
	DRIFT[mV]	*2	20max	20max	48max	60max	96max	192max
START-UP TIME[ms]	500max (ACIN 85V, Io=100%)							
HOLD-UP TIME[ms]	20typ (Io=100%)							
OUTPUT VOLTAGE ADJUSTMENT RANGE[V]	2.85 - 3.6	±10%						
PROTECTION CIRCUIT AND OTHERS	OVERCURRENT PROTECTION	Works over 105% of rating and recovers automatically						
	OVERVOLTAGE PROTECTION	4.00 - 5.25V	Works at 115 - 140% of rating					
	OPERATING INDICATION	LED (Green)						
	REMOTE SENSING	Provided						
REMOTE ON/OFF	Optional (Refer to Instruction Manual)							
ISOLATION	INPUT-OUTPUT · RC	*3	AC3.000V 1minute, Cutoff current = 10mA, DC500V 50MΩ min (At Room Temperature)					
	INPUT-FG		AC2.000V 1minute, Cutoff current = 10mA, DC500V 50MΩ min (At Room Temperature)					
	OUTPUT · RC-FG	*3	AC500V 1minute, Cutoff current = 100mA, DC500V 50MΩ min (At Room Temperature)					
	OUTPUT-RC	*3	AC100V 1minute, Cutoff current = 100mA, DC100V 10MΩ min (At Room Temperature)					
ENVIRONMENT	OPERATING TEMP., HUMID. AND ALTITUDE	-10 to +65°C, 20 - 90%RH (Non condensing) (Refer to DERATING CURVE), 3,000m (10,000feet) max						
	STORAGE TEMP., HUMID. AND ALTITUDE	-20 to +75°C, 20 - 90%RH (Non condensing), 9,000m (30,000feet) max						
	VIBRATION	10 - 55Hz, 19.6m/s <sup>2</sup> (2G), 3minutes period, 60minutes each along X, Y and Z axis						
	IMPACT	196.1m/s <sup>2</sup> (20G), 11ms, once each X, Y and Z axis						
SAFETY AND NOISE REGULATIONS	AGENCY APPROVALS	UL60950-1, EN60950-1, EN50178, CSA C22.2 No.60950-1 Complies with DEN-AN and IEC60950-1						
	CONDUCTED NOISE	Complies with FCC-B, CISPR22-B, EN55022-B, VCCI-B						
	HARMONIC ATTENUATOR	Complies with IEC61000-3-2						
OTHERS	CASE SIZE/WEIGHT	50×93×189mm (without terminal block) (W×H×D) /700g max (without cover)						
	COOLING METHOD	Convection						

\*1 According to 20MHz oscilloscope or Ripple-Noise meter (equivalent to KEISOKU-GIKEN : RM101).  
 \*2 Drift is change in DC output for an eight hour period after a half-hour warm-up at 25°C, with the input voltage held constant at the rated input/output.  
 \*3 Applicable when Remote ON/OFF (optional) is added.  
 \*4 Please contact us about safety approvals for the model with option.  
 \* Derating is required when operated with cover.

## External view

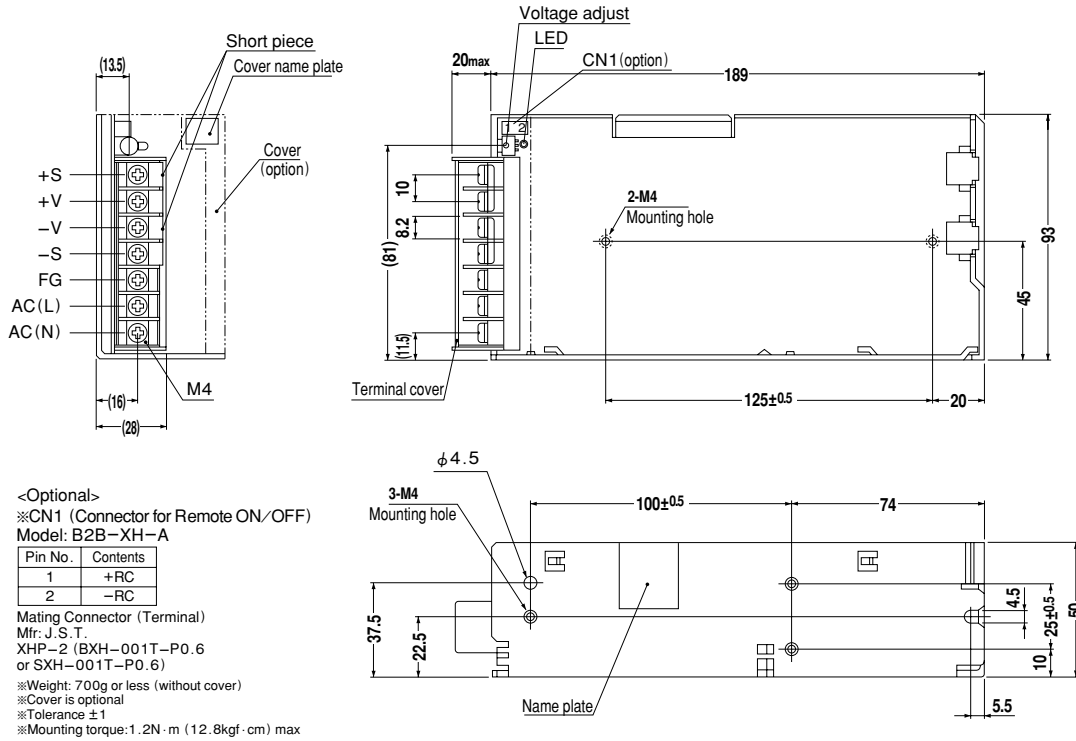

## Performance data

### RISE TIME & FALL TIME (PAA100F-5)

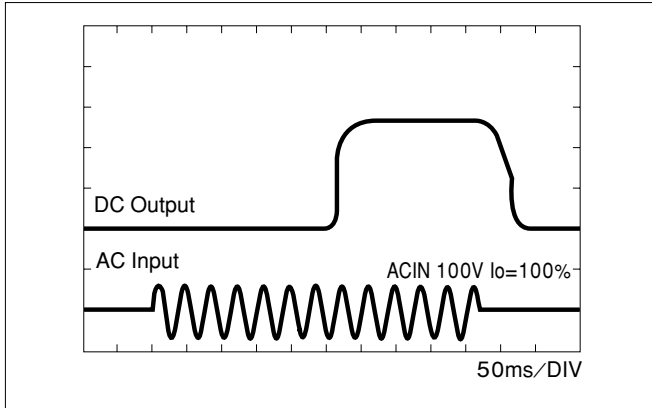

### EFFICIENCY (PAA100F-5)

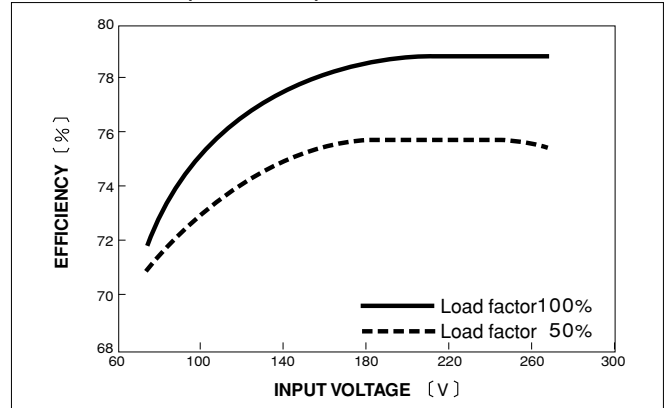

### HARMONIC CURRENT (PAA100F-5)

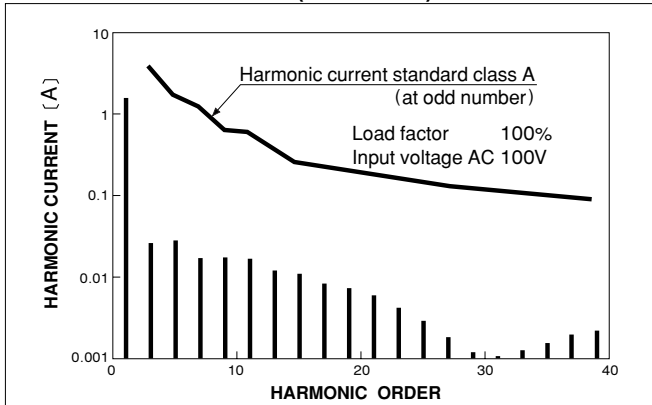

### HARMONIC CURRENT (PAA100F-5)

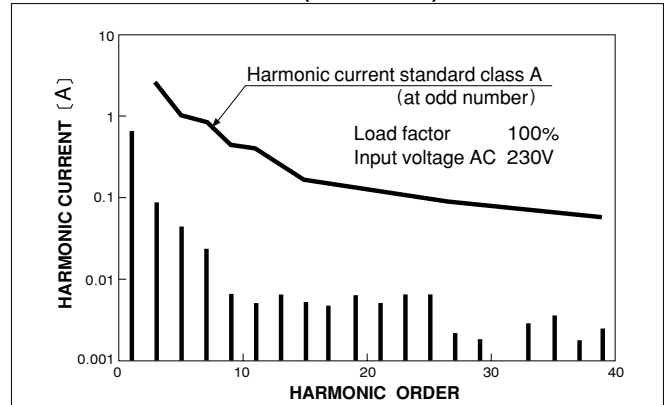

# PAA150F

PAA 150 F -5 -□

① ② ③ ④ ⑤

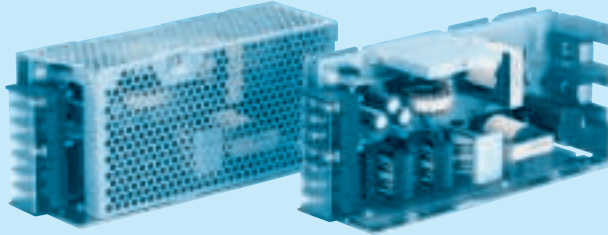

Recommended EMI/EMC Filter  
NAC-06-472



High voltage pulse noise type : NAP series  
Low leakage current type : NAM series  
\*The EMI/EMC Filter is recommended to connect with several devices.

- ① Series name
- ② Output wattage
- ③ Universal input
- ④ Output voltage
- ⑤ Optional \*4
- C :with Coating
- G :Low leakage current
- N :with Cover
- R :with Remote ON/OFF

MODEL	PAA150F-3	PAA150F-5	PAA150F-12	PAA150F-15	PAA150F-24	PAA150F-48
MAX OUTPUT WATTAGE[W]	90	150	156	150	156	158.4
DC OUTPUT	3V 30A	5V 30A	12V 13A	15V 10A	24V 6.5A	48V 3.3A

## SPECIFICATIONS

	MODEL	PAA150F-3	PAA150F-5	PAA150F-12	PAA150F-15	PAA150F-24	PAA150F-48	
INPUT	VOLTAGE[V]	AC85 - 264 1 φ or DC120 - 340						
	CURRENT[A]	ACIN 100V	1.4typ	2.0typ				
		ACIN 200V	0.7typ	1.0typ				
	FREQUENCY[Hz]	50/60 (47 - 63)						
	EFFICIENCY[%]	67typ	75typ	78typ	80typ	81typ	81typ	
	POWER FACTOR	ACIN 100V	0.99typ (Io=100%)					
		ACIN 200V	0.95typ (Io=100%)					
	INRUSH CURRENT[A]	ACIN 100V	20typ (Io=100%) (At cold start)					
ACIN 200V		40typ (Io=100%) (At cold start)						
LEAKAGE CURRENT[ma]	0.75max (60Hz, According to UL, CSA, VDE and DEN-AN)							
OUTPUT	VOLTAGE[V]	3	5	12	15	24	48	
	CURRENT[A]	30	30	13	10	6.5	3.3	
	LINE REGULATION[mV]	20max	20max	48max	60max	96max	192max	
	LOAD REGULATION[mV]	40max	40max	100max	120max	150max	240max	
	RIPPLE[mVp-p]	0 to +50°C *1	80max	80max	120max	120max	120max	150max
		-10 - 0°C *1	140max	140max	160max	160max	160max	200max
	RIPPLE NOISE[mVp-p]	0 to +50°C *1	120max	120max	150max	150max	150max	400max
		-10 - 0°C *1	160max	160max	180max	180max	180max	600max
	TEMPERATURE REGULATION[mV]	0 to +50°C	50max	50max	120max	150max	240max	480max
		-10 to +50°C	60max	60max	150max	180max	290max	600max
	DRIFT[mV]	*2	20max	20max	48max	60max	96max	192max
START-UP TIME[ms]	500max (ACIN 85V, Io=100%)							
HOLD-UP TIME[ms]	20typ (Io=100%)							
OUTPUT VOLTAGE ADJUSTMENT RANGE[V]	2.85 - 3.6	±10%						
PROTECTION CIRCUIT AND OTHERS	OVERCURRENT PROTECTION	Works over 105% of rating and recovers automatically						
	OVERVOLTAGE PROTECTION	4.00 - 5.25V	Works at 115 - 140% of rating					
	OPERATING INDICATION	LED (Green)						
	REMOTE SENSING	Provided						
REMOTE ON/OFF	Optional (Refer to Instruction Manual)							
ISOLATION	INPUT-OUTPUT · RC	*3	AC3.000V 1minute, Cutoff current = 10mA, DC500V 50MΩ min (At Room Temperature)					
	INPUT-FG		AC2.000V 1minute, Cutoff current = 10mA, DC500V 50MΩ min (At Room Temperature)					
	OUTPUT · RC-FG	*3	AC500V 1minute, Cutoff current = 100mA, DC500V 50MΩ min (At Room Temperature)					
	OUTPUT-RC	*3	AC100V 1minute, Cutoff current = 100mA, DC100V 10MΩ min (At Room Temperature)					
ENVIRONMENT	OPERATING TEMP., HUMID. AND ALTITUDE	-10 to +65°C, 10 - 90%RH (Non condensing) (Refer to DERATING CURVE), 3,000m (10,000feet) max						
	STORAGE TEMP., HUMID. AND ALTITUDE	-20 to +75°C, 10 - 90%RH (Non condensing), 9,000m (30,000feet) max						
	VIBRATION	10 - 55Hz, 19.6m/s <sup>2</sup> (2G), 3minutes period, 60minutes each along X, Y and Z axis						
	IMPACT	196.1m/s <sup>2</sup> (20G), 11ms, once each X, Y and Z axis						
SAFETY AND NOISE REGULATIONS	AGENCY APPROVALS	UL60950-1, EN60950-1, EN50178, CSA C22.2 No.60950-1 Complies with DEN-AN and IEC60950-1						
	CONDUCTED NOISE	Complies with FCC-B, CISPR22-B, EN55022-B, VCCI-B						
	HARMONIC ATTENUATOR	Complies with IEC61000-3-2						
OTHERS	CASE SIZE/WEIGHT	65×93×199mm (without terminal block) (W×H×D) /900g max (without cover)						
	COOLING METHOD	Convection						

\*1 According to 20MHz oscilloscope or Ripple-Noise meter (equivalent to KEISOKU-GIKEN : RM101).

\*2 Drift is change in DC output for an eight hour period after a half-hour warm-up at 25°C, with the input voltage held constant at the rated input/output.

\*3 Applicable when Remote ON/OFF (optional) is added.

\*4 Please contact us about safety approvals for the model with option.

\* Derating is required when operated with cover.

External view

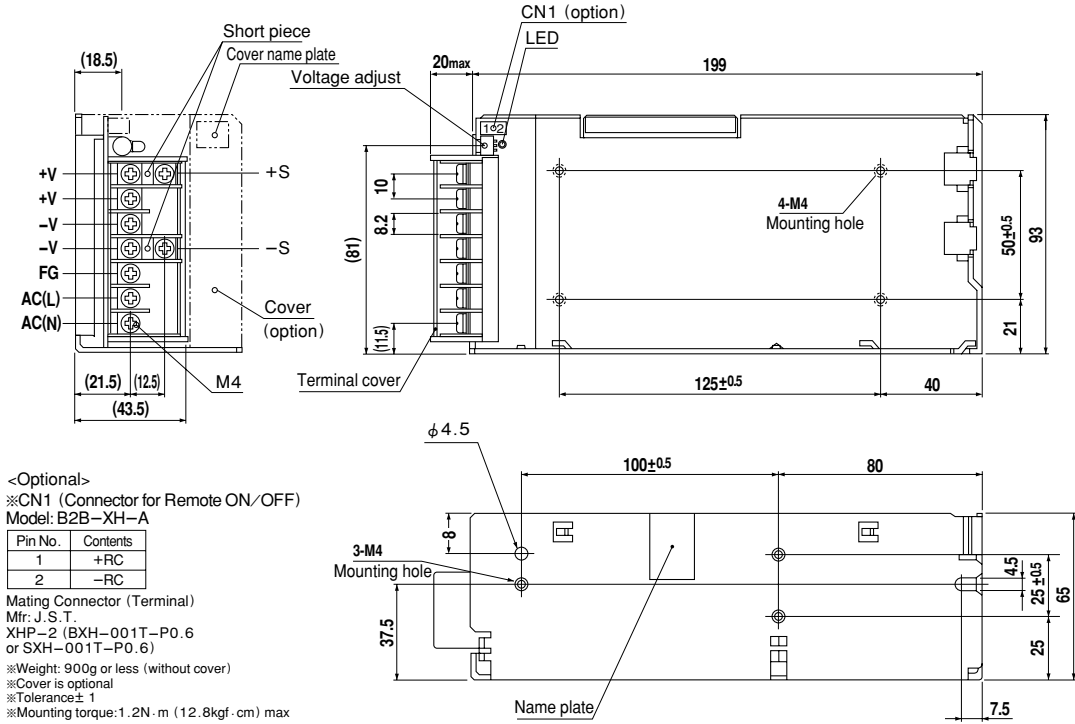

Performance data

RISE TIME & FALL TIME (PAA150F-5)

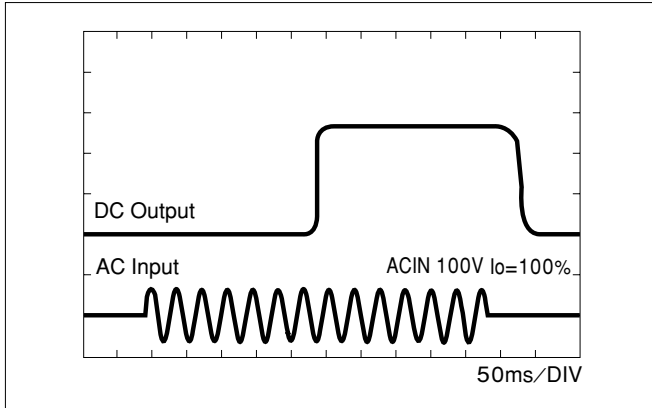

EFFICIENCY (PAA150F-5)

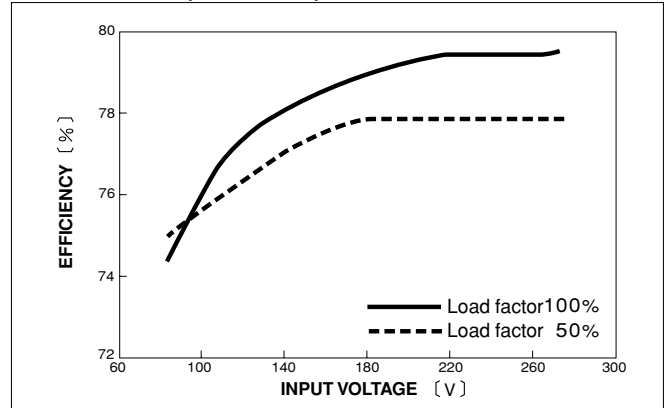

HARMONIC CURRENT (PAA150F-5)

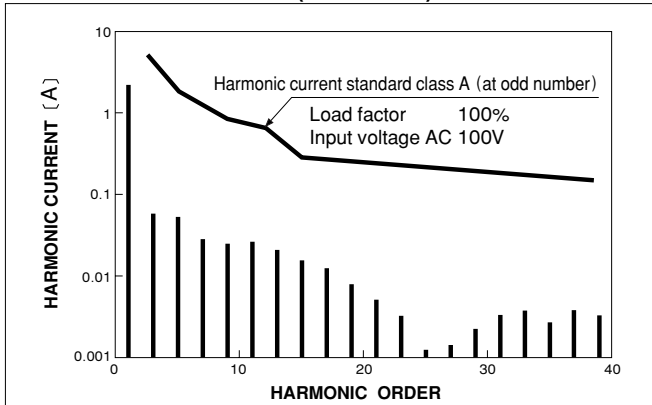

INPUT HARMONIC CURRENT (PAA150F-5)

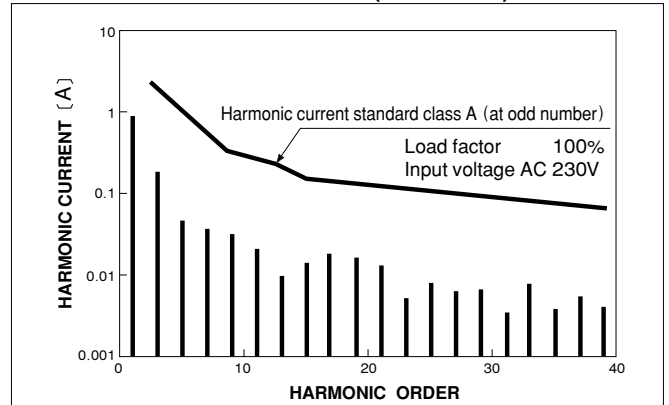



# PAA300F

PAA 300 F -5 -□

① ② ③ ④ ⑤



Recommended EMI/EMC Filter  
NAC-10-472



High voltage pulse noise type : NAP series  
Low leakage current type : NAM series  
\*The EMI/EMC Filter is recommended to connect with several devices.

- ① Series name
- ② Output wattage
- ③ Universal input
- ④ Output voltage
- ⑤ Optional \*3
- C :with Coating
- G :Low leakage current
- R :Positive logic control
- W :with Alarm signal

MODEL	PAA300F-3	PAA300F-5	PAA300F-12	PAA300F-15	PAA300F-24	PAA300F-48
MAX OUTPUT WATTAGE[W]	180	300	324	330	336	336
DC OUTPUT	3V 60A	5V 60A	12V 27A	15V 22A	24V 14A	48V 7A

## SPECIFICATIONS

	MODEL	PAA300F-3	PAA300F-5	PAA300F-12	PAA300F-15	PAA300F-24	PAA300F-48	
INPUT	VOLTAGE[V]	AC85 - 264 1 φ or DC120 - 340						
	CURRENT[A]	ACIN 100V	2.6typ	4.4typ				
		ACIN 200V	1.3typ	2.2typ				
	FREQUENCY[Hz]	50/60 (47 - 63)						
	EFFICIENCY[%]	68typ	74typ	78typ	80typ	81typ	81typ	
	POWER FACTOR	ACIN 100V	0.99typ (Io=100%)					
		ACIN 200V	0.95typ (Io=100%)					
	INRUSH CURRENT[A]	ACIN 100V	20typ (Io=100%)					
ACIN 200V		40typ (Io=100%)						
LEAKAGE CURRENT[ma]	0.75max (60Hz, According to UL, CSA, VDE and DEN-AN)							
OUTPUT	VOLTAGE[V]	3	5	12	15	24	48	
	CURRENT[A]	60	60	27	22	14	7	
	LINE REGULATION[mV]	20max	20max	48max	60max	96max	192max	
	LOAD REGULATION[mV]	40max	40max	100max	120max	150max	300max	
	RIPPLE[mVp-p]	0 to +50°C *1	80max	80max	120max	120max	120max	150max
		-10 - 0°C *1	140max	140max	160max	160max	160max	200max
	RIPPLE NOISE[mVp-p]	0 to +50°C *1	120max	120max	150max	150max	150max	200max
		-10 - 0°C *1	160max	160max	180max	180max	180max	300max
	TEMPERATURE REGULATION[mV]	0 to +50°C	40max	50max	120max	150max	240max	480max
		-10 to +50°C	50max	60max	150max	180max	290max	580max
	DRIFT[mV]	*2	12max	20max	48max	60max	96max	192max
	START-UP TIME[ms]	500max (ACIN 85V, Io=100%)						
HOLD-UP TIME[ms]	20typ (Io=100%)							
OUTPUT VOLTAGE ADJUSTMENT RANGE[V]	2.85 - 3.45	±10%						
PROTECTION CIRCUIT AND OTHERS	OVERCURRENT PROTECTION	Works over 105% of rating and recovers automatically						
	OVERVOLTAGE PROTECTION	4.00 - 5.25V	Works at 115 - 140% of rating					
	OPERATING INDICATION	LED (Green)						
	REMOTE SENSING	Provided						
REMOTE ON/OFF	Provided							
ISOLATION	INPUT-OUTPUT · RC	AC3,000V 1minute, Cutoff current = 10mA, DC500V 50MΩ min (At Room Temperature)						
	INPUT-FG	AC2,000V 1minute, Cutoff current = 10mA, DC500V 50MΩ min (At Room Temperature)						
	OUTPUT · RC-FG	AC500V 1minute, Cutoff current = 100mA, DC500V 50MΩ min (At Room Temperature)						
	OUTPUT-RC	AC100V 1minute, Cutoff current = 100mA, DC100V 50MΩ min (At Room Temperature)						
ENVIRONMENT	OPERATING TEMP.,HUMID.AND ALTITUDE	-10 to +65°C, 20 - 90%RH (Non condensing) (Refer to DERATING CURVE), 3,000m (10,000feet) max						
	STORAGE TEMP.,HUMID.AND ALTITUDE	-20 to +75°C, 20 - 90%RH (Non condensing), 9,000m (30,000feet) max						
	VIBRATION	10 - 55Hz, 19.6m/s <sup>2</sup> (2G), 3minutes period, 60minutes each along X, Y and Z axis						
	IMPACT	196.1m/s <sup>2</sup> (20G), 11ms, once each X, Y and Z axis						
SAFETY AND NOISE REGULATIONS	AGENCY APPROVALS	UL60950-1, EN60950-1, EN50178, CSA C22.2 No.60950-1 Complies with DEN-AN and IEC60950-1						
	CONDUCTED NOISE	Complies with FCC-B, CISPR22-B, EN55022-B, VCCI-B						
	HARMONIC ATTENUATOR	Complies with IEC61000-3-2						
OTHERS	CASE SIZE/WEIGHT	120×92×190mm (without terminal block and screw) (W×H×D) /2.2kg max						
	COOLING METHOD	Forced cooling (internal fan)						

\*1 According to 20MHz oscilloscope or Ripple-Noise meter(equivalent to KEISOKU-GIKEN : RM101).

\*2 Drift is change in DC output for an eight hour period after a half-hour warm-up at 25°C, with the input voltage held constant at the rated input/output.

\*3 Please contact us about safety approvals for the model with option.

\* Avoid prolonged use under over-load.

External view

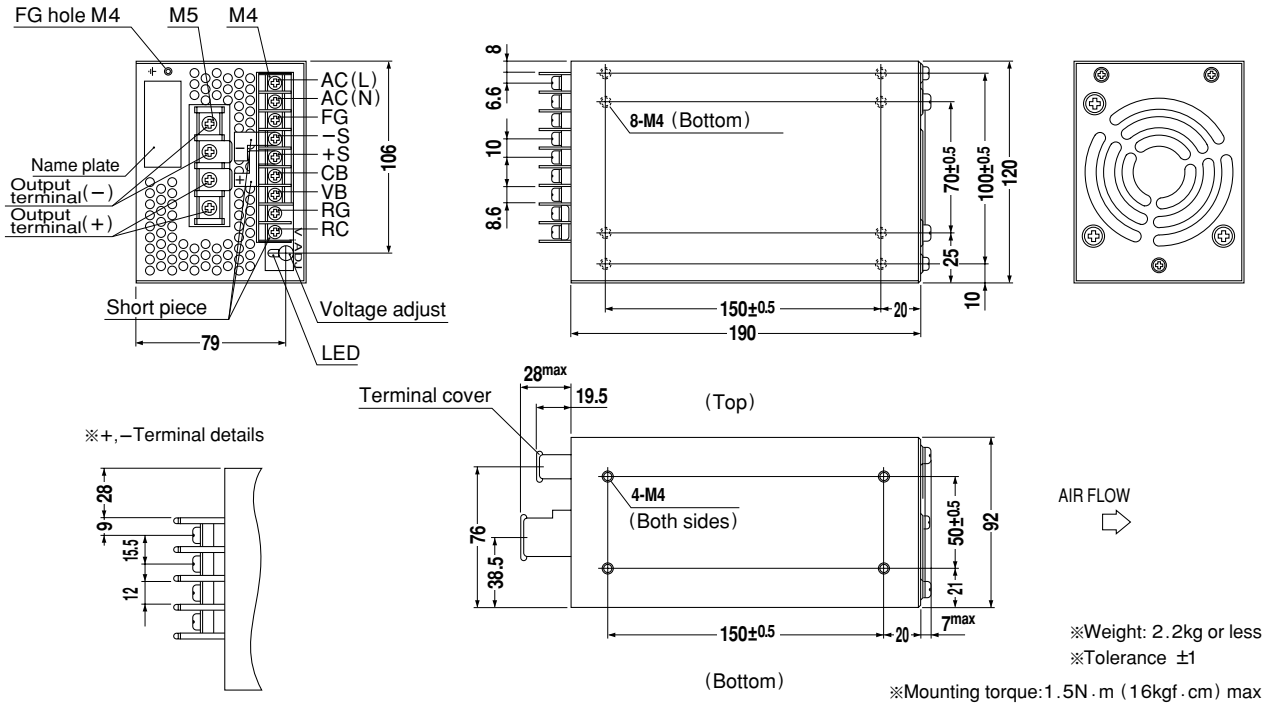

Performance data

RISE TIME & FALL TIME (PAA300F-5)

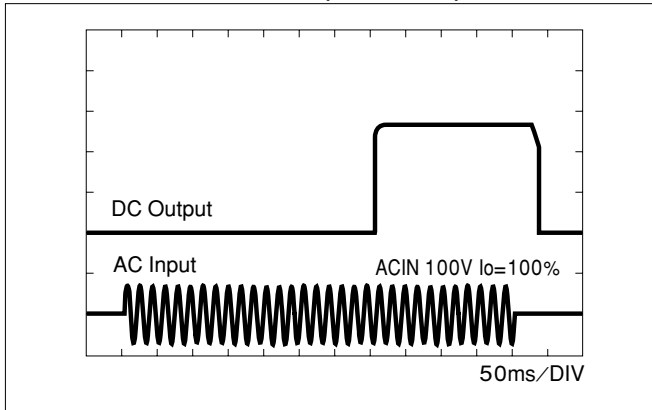

EFFICIENCY (PAA300F-5)

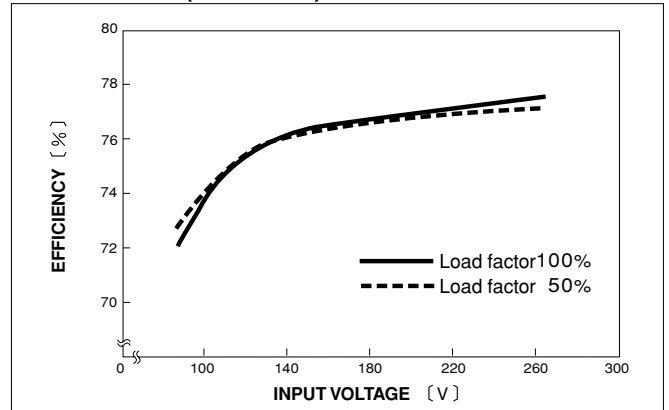

HARMONIC CURRENT (PAA300F-5)

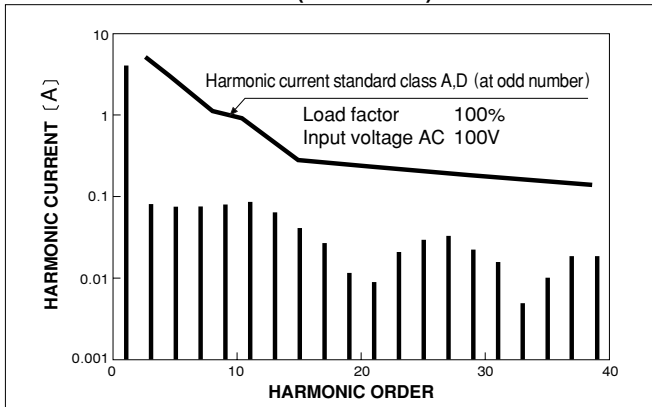

INPUT HARMONIC CURRENT (PAA300F-5)

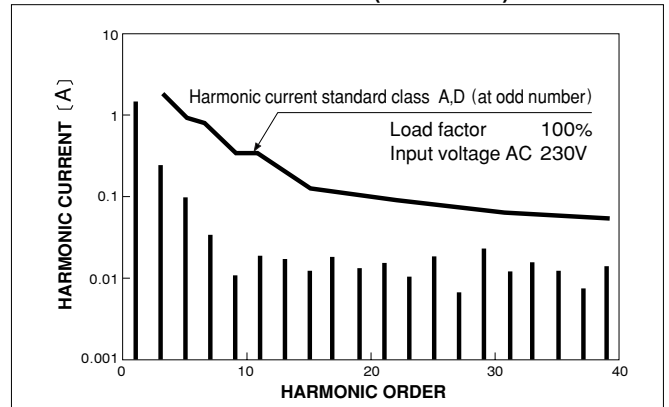

# PAA600F

PAA 600 F -5 -□

① ② ③ ④ ⑤

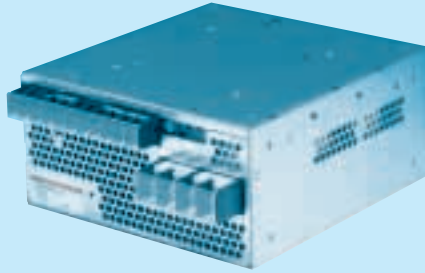

Recommended EMI/EMC Filter  
NAC-16-472



High voltage pulse noise type : NAP series  
Low leakage current type : NAM series  
\*The EMI/EMC Filter is recommended to connect with several devices.

- ① Series name
- ② Output wattage
- ③ Universal input
- ④ Output voltage
- ⑤ Optional \*3
- C :with Coating
- G :Low leakage current
- R :Positive logic control
- W :with Alarm signal

MODEL	PAA600F-3	PAA600F-5	PAA600F-12	PAA600F-15	PAA600F-24	PAA600F-48
MAX OUTPUT WATTAGE[W]	360	600	636	645	648	624
DC OUTPUT	3V 120A	5V 120A	12V 53A	15V 43A	24V 27A	48V 13A

## SPECIFICATIONS

	MODEL	PAA600F-3	PAA600F-5	PAA600F-12	PAA600F-15	PAA600F-24	PAA600F-48	
INPUT	VOLTAGE[V]	AC85 - 264 1 φ or DC120 - 340						
	CURRENT[A]	ACIN 100V	5.4typ	8.2typ				
		ACIN 200V	2.7typ	4.1typ				
	FREQUENCY[Hz]	50/60 (47 - 63)						
	EFFICIENCY[%]	70typ	76typ	80typ	81typ	83typ	83typ	
	POWER FACTOR	ACIN 100V	0.99typ (Io=100%)					
		ACIN 200V	0.95typ (Io=100%)					
	INRUSH CURRENT[A]	ACIN 100V	20typ (Io=100%)					
ACIN 200V		40typ (Io=100%)						
LEAKAGE CURRENT[ma]	0.75max (60Hz, According to UL, CSA, VDE and DEN-AN)							
OUTPUT	VOLTAGE[V]	3	5	12	15	24	48	
	CURRENT[A]	120	120	53	43	27	13	
	LINE REGULATION[mV]	20max	20max	48max	60max	96max	192max	
	LOAD REGULATION[mV]	40max	40max	100max	120max	150max	300max	
	RIPPLE[mVp-p]	0 to +50°C *1	80max	80max	120max	120max	120max	150max
		-10 - 0°C *1	140max	140max	160max	160max	160max	200max
	RIPPLE NOISE[mVp-p]	0 to +50°C *1	120max	120max	150max	150max	150max	200max
		-10 - 0°C *1	160max	160max	180max	180max	180max	300max
	TEMPERATURE REGULATION[mV]	0 to +50°C	40max	50max	120max	150max	240max	480max
		-10 to +50°C	50max	60max	150max	180max	290max	580max
	DRIFT[mV]	*2	12max	20max	48max	60max	96max	192max
	START-UP TIME[ms]	500max (ACIN 85V, Io=100%)						
HOLD-UP TIME[ms]	20typ (ACIN 100V, Io=100%)							
OUTPUT VOLTAGE ADJUSTMENT RANGE[V]	2.85 - 3.45		±10%					
PROTECTION CIRCUIT AND OTHERS	OVERCURRENT PROTECTION	Works over 105% of rating and recovers automatically						
	OVERVOLTAGE PROTECTION	4.00 - 5.25V	Works at 115 - 140% of rating					
	OPERATING INDICATION	LED (Green)						
	REMOTE SENSING	Provided						
ISOLATION	REMOTE ON/OFF	Provided						
	INPUT-OUTPUT · RC	AC3.000V 1minute, Cutoff current = 10mA max.DC500V 50MΩ min (At Room Temperature)						
	INPUT-FG	AC2.000V 1minute, Cutoff current = 10mA max.DC500V 50MΩ min (At Room Temperature)						
	OUTPUT · RC-FG	AC500V 1minute, Cutoff current = 100mA max.DC500V 50MΩ min (At Room Temperature)						
	OUTPUT-RC	AC100V 1minute, Cutoff current = 100mA max.DC100V 50MΩ min (At Room Temperature)						
ENVIRONMENT	OPERATING TEMP.,HUMID.AND ALTITUDE	-10 to +65°C, 20 - 90%RH (Non condensing) (Refer to DERATING CURVE), 3,000m (10,000feet) max						
	STORAGE TEMP.,HUMID.AND ALTITUDE	-20 to +75°C, 20 - 90%RH (Non condensing), 9,000m (30,000feet) max						
	VIBRATION	10 - 55Hz, 19.6m/s <sup>2</sup> (2G), 3minutes period, 60minutes each along X, Y and Z axis						
	IMPACT	196.1m/s <sup>2</sup> (20G), 11ms, once each X, Y and Z axis						
SAFETY AND NOISE REGULATIONS	AGENCY APPROVALS	UL60950-1, EN60950-1, EN50178, CSA C22.2 No.60950-1 Complies with DEN-AN and IEC60950-1						
	CONDUCTED NOISE	Complies with FCC-B, CISPR22-B, EN55022-B, VCCI-B						
	HARMONIC ATTENUATOR	Complies with IEC61000-3-2						
OTHERS	CASE SIZE/WEIGHT	190×92×200mm (without terminal block and screw) (W×H×D) /4.0kg max						
	COOLING METHOD	Forced cooling (internal fan)						

\*1 According to 20MHz oscilloscope or Ripple-Noise meter(equivalent to KEISOKU-GIKEN : RM101).

\*2 Drift is change in DC output for an eight hour period after a half-hour warm-up at 25°C, with the input voltage held constant at the rated input/output.

\*3 Please contact us about safety approvals for the model with option.

\* Avoid prolonged use under over-load.

External view

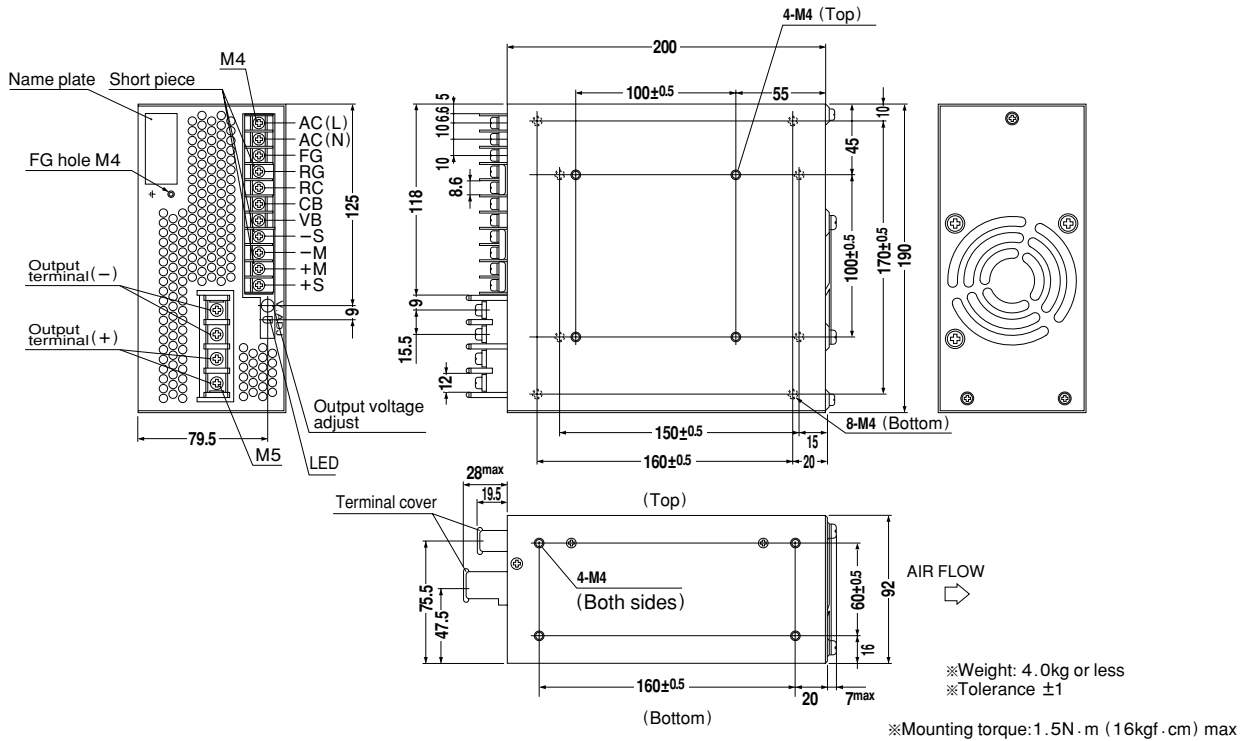

Performance data

RISE TIME & FALL TIME (PAA600F-5)

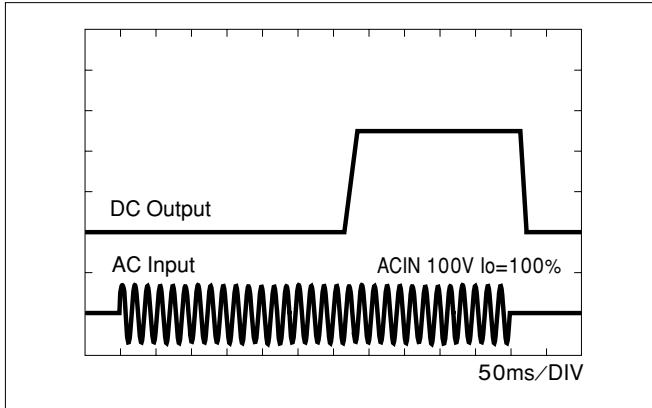

EFFICIENCY (PAA600F-5)

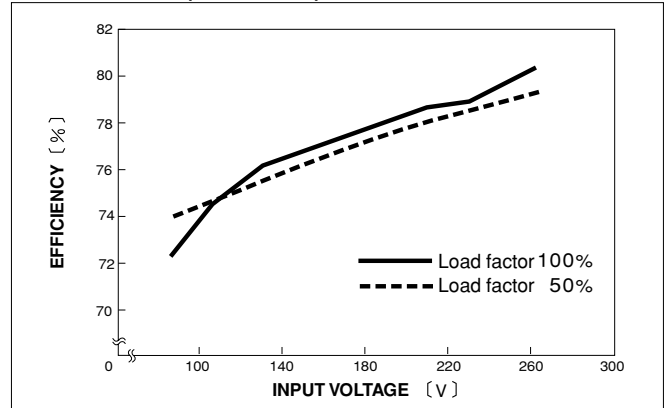

HARMONIC CURRENT (PAA600F-5)

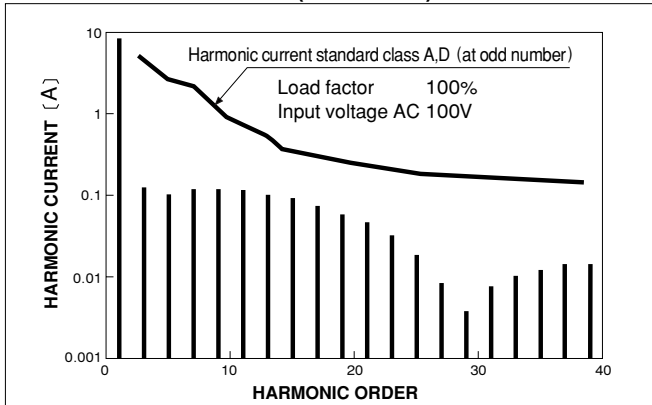

HARMONIC CURRENT (PAA600F-5)

