

Albright

INTERNATIONAL

80 Ampere Miniature Direct Current Contactors

The Use of Miniature DC Contactors

The "PC", "MB" & "SW" contactors represent a novel dual approach to the requirements for DC contactors.

On the one hand the expansion of Telecommunications Systems, UPS and other Power Conversion Systems has led to a demand for compact, easily installed and economically priced contactors which up until now have not been available. With the introduction of the "PC60" & "MB60" contactors, this demand has now been effectively met.

On the other hand the "SW60" range fulfills the requirements for more traditional DC contactor applications: switching or reversing small traction motors, hydraulic power packs, small electric winch motors, etc.

All the contactors are manufactured to a very high standard and employ best quality materials: phenolic contact housings, silver alloy contacts and Class H (180°C) winding wire for the coils. Silver plated heavy current and gold plated light current components are also used on the "PC60" & "MB60" contactors.

These new contactors are a unique and innovative introduction from the world's leading manufacturer of DC contactors.

PC60

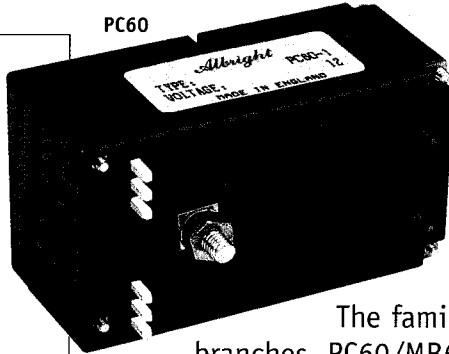

The "PC60", "MB60" & "SW60" are a new family of miniature direct current contactors and solenoid switches which are designed to fill the gap between 30 ampere relays and 100 ampere contactors.

The family is divided into two distinct branches, PC60/MB60 for printed circuit board mounting and SW60 free standing contactors and each has its own selection of variations and options.

PC SERIES
PCB MOUNTING
MINIATURE DC CONTACTORS

These are unique designs for printed circuit board mounting and the following variations and configurations are available:

TYPE NO.	DESCRIPTION
PC60	Single Pole On/Off Normally Open Contactor (SP ST NO)
PC61	Single Pole Changeover Contactor (SP DT)
PC63	Single Pole On/Off Normally Closed Contactor (SP ST NC)

Magnetic Blowouts *PC60B, PC61B & PC63B*

The contactors can be fitted with magnetic blowouts for switching current at higher dc voltages (guide: >60V for resistive loads and >48V for inductive loads).

If the application calls for frequent switching under these conditions, it is recommended that a contact housing with open apertures is specified. This is available as a no cost option.

When fitted with magnetic blowouts it is important that the correct polarity for the main terminal connections is observed.

Auxiliary Contacts *PC60A, PC61A & PC63A*

A double circuit changeover 5 ampere microswitch auxiliary contact can be provided.

This is fitted in a purpose designed holder with gold plated pickups for the microswitch terminals and pins for soldering direct to a printed circuit board.

Protected Versions PC60.P, PC61.P & PC63.P

These have closed contact housings, and are assembled with rubber gaskets to inhibit the ingress of moisture or other contamination. They are protected to IP66.

These versions can be washed after soldering to the board and may be used in dirty or wet environments.

Please note:

Contactors fitted with auxiliary contacts cannot be fully protected against unfriendly environments.

Washable Contactors with Auxiliary Contacts

PC60A.W, PC61A.W & PC63A.W

Normally the auxiliary contacts are supplied already fitted to the contactor but if the printed circuit boards are to be washed after soldering, the auxiliary contact is supplied separately and the contactor is temporarily sealed with a rubber plug which is removed after washing and the auxiliary contact is then fitted.

The contactors are not therefore fully protected against the environment to the same degree as the PC60.P, PC61.P and PC63.P.

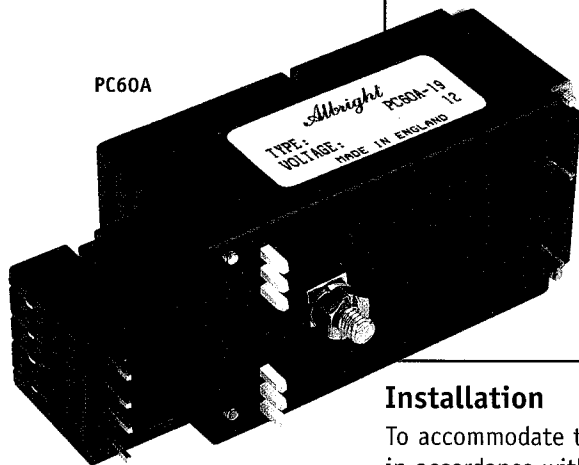
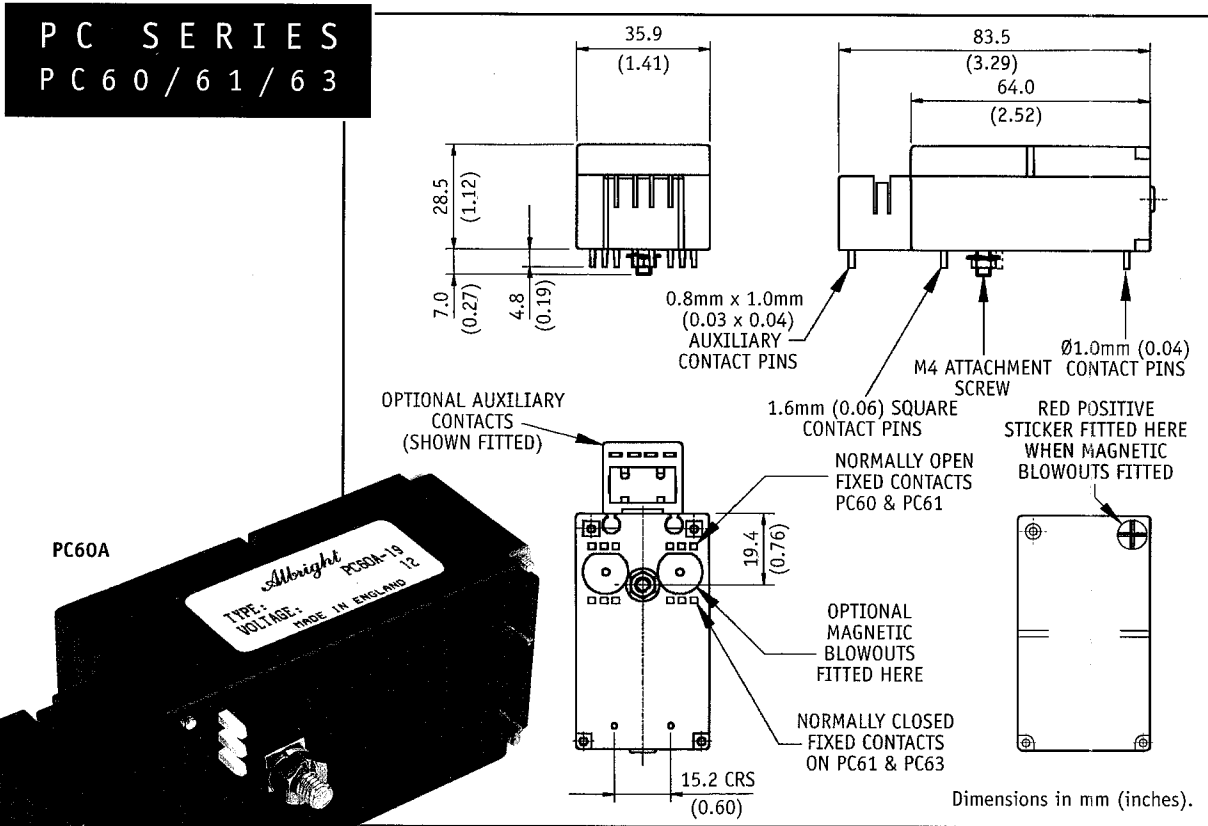

Installation

To accommodate the "PC" contactors, printed circuit boards should be drilled in accordance with the drawing on page 4.

Prior to soldering, the PC60, PC61 and PC63 can be secured to the circuit board by means of a M4 bolt which protrudes from the underside of the contactor.

If the full current ratings of the contactors are to be utilised, circuit board tracks should have the appropriate thickness and width of copper.

Conventional hand or wave soldering techniques can be used and if the circuit board is to be washed the appropriate PC60.P, PC61.P, PC63.P or PC60A.W, PC61A.W, PC63A.W should be specified.

Explanation of Type Numbers

PC60 - A - B - P - W - M

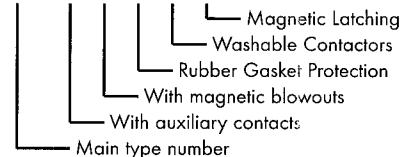

**80 Ampere
Miniature
DC Contactors
from...**

Albright
INTERNATIONAL

M B SERIES

CONTACTORS WITH A SEPARATE MOUNTING BASE

TYPE NO.	DESCRIPTION
MB60	PC60 with Mounting Base Normally Open Contactor (SP ST NO)
MB61	PC61 with Mounting Base Changeover Contactor (SP DT)
MB63	PC63 with Mounting Base Normally Closed Contactor (SP ST NC)

All versions of "PC" contactors can be supplied with a separate mounting base which can be soldered to the circuit board.

After soldering and washing the printed circuit board, the 'PC' contactor can be plugged into the base and secured by means of a nut on the underside of the board.

Removal for servicing or replacement is possible by removal of the nut and unplugging the PC contactor from the base.

M B SERIES M B 6 0 / 6 1 / 6 3

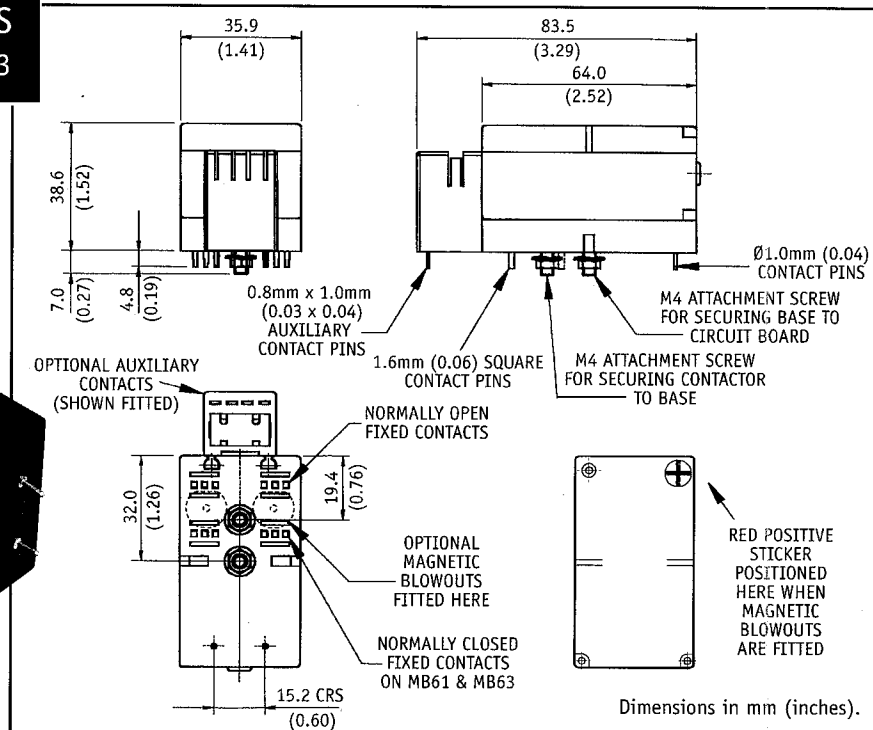
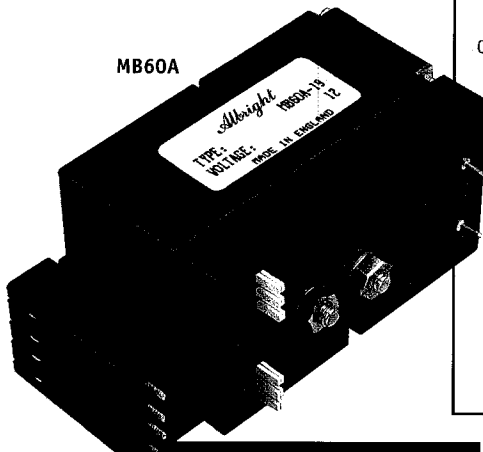

PC / MB MOUNTING DETAILS

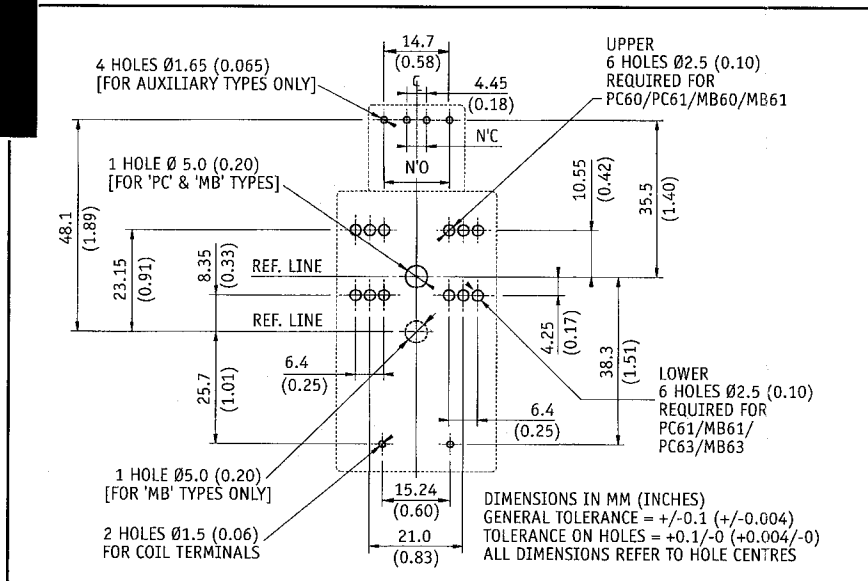

**80 Ampere
Miniature
DC Contactors
from...**

Albright
INTERNATIONAL

S W S E R I E S

F R E E S T A N D I N G M I N I A T U R E

D C C O N T A C T O R S

These are freestanding contactors and are more conventionally configured: they have M6 main terminals, 0.25" (6.3mm) coil terminals and a selection of alternative mountings are available.

TYPE NO.	DESCRIPTION
SW60	Single Pole On/Off Normally Open Contactor (SP ST NO)
SW61	Single Pole Changeover Contactor (SP DT)
SW63	Single Pole On/Off Normally Closed Contactor (SP ST NC) AVAILABLE YEAR 2000
SW64	Paired Single Pole On/Off Contactor (2 x SP ST NO)
SW66	Paired Single Pole Changeover Contactor (2 x SP DT)

Magnetic Blowouts

SW60B, SW61B, SW63B & SW64B

The contactors can be fitted with magnetic blowouts for switching current at higher DC voltages (guide: >60V for resistive loads and >48V for inductive loads).

If the application calls for frequent switching under these conditions it is recommended that a contact housing with open apertures is specified. This is available as a no cost option.

When fitted with magnetic blowouts it is important that the correct polarity for the main terminal connections is observed.

Auxiliary Contacts

SW60A, SW61A, SW63A, SW64A & SW66A

A double circuit changeover 5 Ampere microswitch

auxiliary contact can be provided.

This is fitted in a purpose designed holder mounted between the main terminals and has 2mm spade connections.

Protected Versions *SW60.P, SW63.P & SW64.P*

These contactors have closed contact housings and are sealed to inhibit the ingress of moisture or other contamination.

They can therefore be used in environments which require protection to IP66.

Please note:

Contactors fitted with auxiliary contacts cannot be fully protected against unfriendly environments.

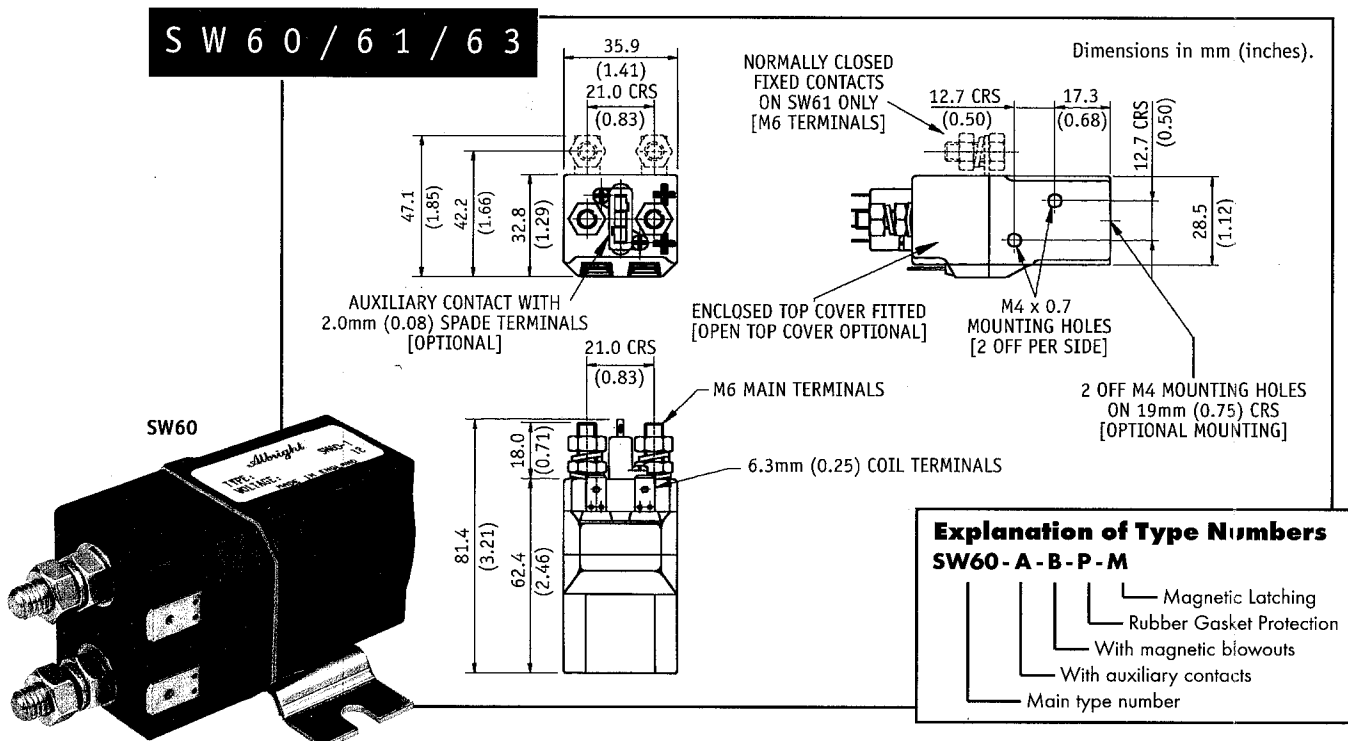

MOUNTING OPTIONS

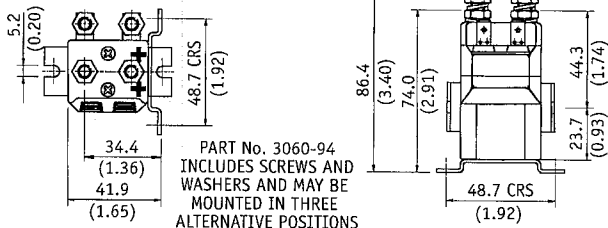

Installation

Mounting is by M4 tapped holes in the contactor frame together with a selection of mounting brackets.

Standard arrangement is for the contactors to be supplied with two M4 holes on each side of the contactor frame to allow direct attachment to panels etc.

For other options see left.

Paired Contactors SW64 & SW66

The contactors can be supplied in assembled pairs with the appropriate connecting links. In the case of the SW66, the contactor is configured with links for motor reversing. The resultant circuit is failsafe so that if both coils are energised simultaneously, an open circuit results.

SW64 / 66

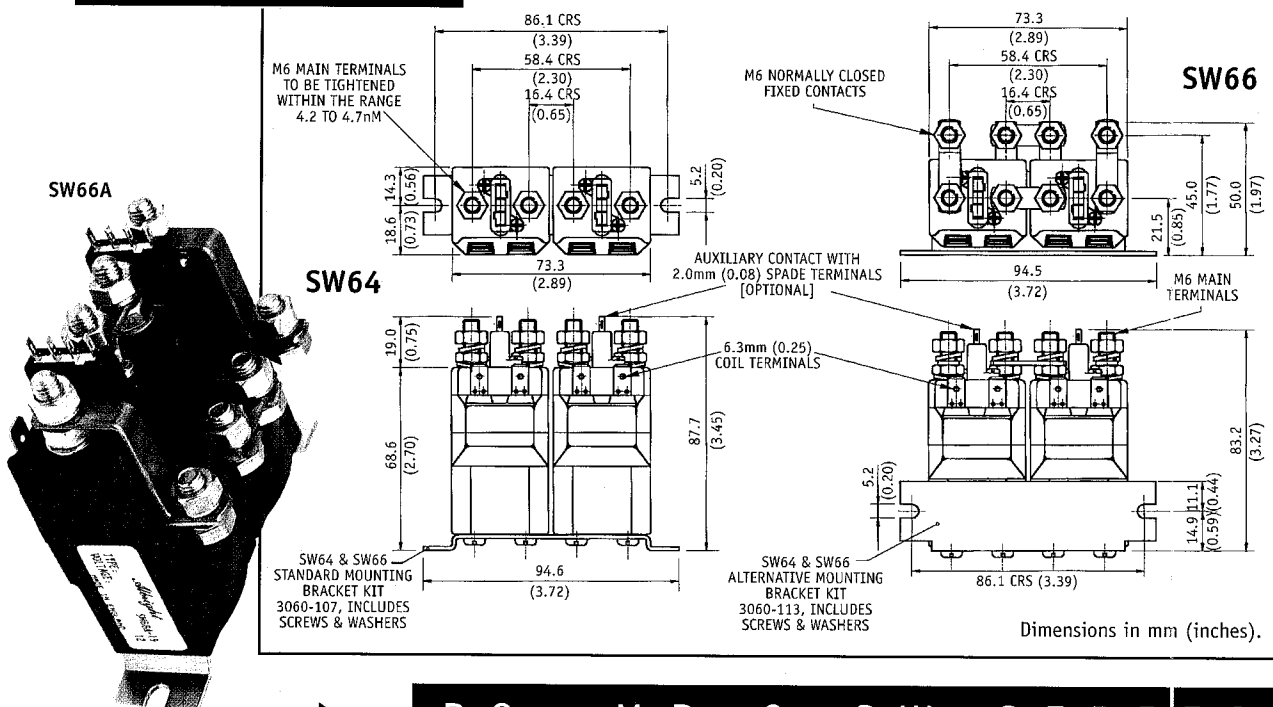

PC, MB & SW SERIES MAGNETICALLY LATCHED DC CONTACTORS

Please Note. Very Important:

Magnetically latched contactors do not fail safe. If there is a power failure, or if the supply to the contactor coil is broken, the contactor contacts will not open or close, ie the contactor will not change state. These devices should not therefore be used in applications where the failure of contacts to open or close could result in a hazardous situation for persons or equipment.

Magnetically Latched PC60, MB60 and SW60

PC60M, MB60M & SW60M

The contactors can be supplied with magnetic latching - one short pulse to close the main contacts - one short pulse to reopen them again.

The result is a bi-stable device, the coil of which consumes no power except during the closing and opening strokes, and because there is in effect no heating of the coil, the contactors can be engineered in the first place with more powerful coils and springs than with conventional contactors.

Contact ratings and all external dimensions are identical to those of the equivalent types which have conventionally energised coils.

Similarly all the additional features which are available with the other PC60 and SW60 types can be found with the magnetically latched versions, eg auxiliary contacts, magnetic blowouts for the main contacts, protected, etc.

For more details of the operation of the "M" versions, please see the Albright publication:

"Power Consumption Reduction for Albright Contactors".

SUMMARY OF TYPES AVAILABLE

Contactor Key: SP = Single Pole; ST = Single Throw; DT = Double Throw; NO = Normally Open; NC = Normally Closed

Printed Circuit Board Versions

PC60 Single Pole On/Off Normally Open Contactor		PC61 Single Pole Changeover Contactor		PC63 Single Pole On/Off Normally Closed Contactor	
PC60	SP ST NO	PC61	SP DT	PC63	SP ST NC
PC60A	SP ST NO with 5A SP DT auxiliary contact fitted	PC61A	SP DT with 5A SP DT auxiliary contact fitted	PC63A	SP ST NC with 5A SP DT auxiliary contact fitted
PC60B	SP ST NO with magnetic blowouts	PC61B	SP DT with magnetic blowouts	PC63B	SP ST NC with magnetic blowouts
PC60P	SP ST NO protected against the environment	PC61P	SP DT protected against the environment	PC63P	SP ST NC protected against the environment
PC60A.W	SP ST NO washable with separately supplied auxiliary contact	PC61A.W	SP DT washable with separately supplied auxiliary contact	PC63A.W	SP ST NC washable with separately supplied auxiliary contact
PC60M	SP ST NO with magnetic latching				

The options 'A', 'B' & 'M' may be mixed, as may 'B', 'P' & 'M'; but note 'A' & 'P' are not possible. 'A' & 'W' can however be mixed (see text)

"PC" Contactors with Mounting Bases

MB60 Single Pole On/Off Normally Open Contactor with Mounting Base		MB61 Single Pole Changeover Contactor with Mounting Base		MB63 Single Pole On/Off Normally Closed Contactor with Mounting Base	
MB60	SP ST NO	MB61	SP DT	MB63	SP ST NC
MB60A	SP ST NO with 5A SP DT auxiliary contact fitted	MB61A	SP DT with 5A SP DT auxiliary contact fitted	MB63A	SP ST NC with 5A SP DT auxiliary contact fitted
MB60B	SP ST NO with magnetic blowouts	MB61B	SP DT With magnetic blowouts	MB63B	SP ST NC with magnetic blowouts
MB60A.W	SP ST NO washable with separately supplied auxiliary contact	MB61A.W	SP DT washable with separately supplied auxiliary contact	MB63A.W	SP ST NC washable with separately supplied auxiliary contact
MB60M	SP ST NO with magnetic latching				

The options 'A', 'B' & 'M' may be mixed, as may 'B', 'P' & 'M'; but note 'A' & 'P' are not possible. 'A' & 'W' can however be mixed (see text)

Free Standing Versions

SW60 Single Pole On/Off Normally Open Contactor		SW61 Single Pole Changeover Contactor		SW63 Single Pole On/Off Normally Closed Contactor	
SW60	SP ST NO	SW61	SP DT	SW63	SP ST NC
SW60A	SP ST NO with 5A SP DT auxiliary contact fitted	SW61A	SP DT with 5A SP DT auxiliary contact fitted	SW63A	SP ST NC with 5A SP DT auxiliary contact fitted
SW60B	SP ST NO with magnetic blowouts	SW61B	SP DT with magnetic blowouts	SW63B	SP ST NC with magnetic blowouts
SW60P	SP ST NO protected against the environment			SW63P	SP ST NC protected against the environment
SW60M	SP ST NO with magnetic latching				

SW64 Paired Single Pole On/Off Normally Open Contactor				SW66 Paired Single Pole Changeover Contactor			
SW64	2 x SW60	SW64P	2 x SW60P	SW66	2 x SW61	SW66A	2 x SW61A
SW64A	2 x SW60A	SW64M	2 x SW60M				
SW64B	2 x SW60B						

The options 'A', 'B' & 'M' may be mixed, as may 'B', 'P' & 'M'; but note 'A' & 'P' are not possible.

PERFORMANCE DATA FOR ALL SWITCHES

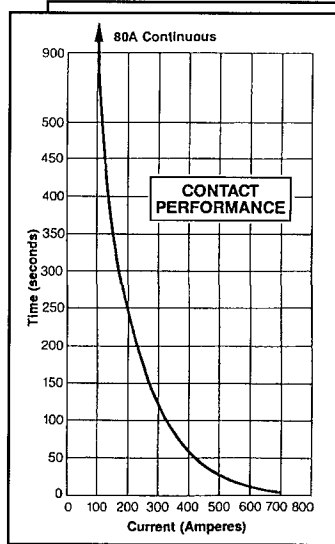

Thermal Current Ratings (100%)

(a) When main contacts are connected to well ventilated conductors having adequate cross sectional areas and when switching of main contacts is infrequent, continuous currents up to 80 Amperes DC may be carried.

(b) When more arduous switching duties are required and when main conductors are reduced in size or are insulated, some reduction of thermal current may be necessary.

The Following Direct Currents May Be Carried on Reduced Duty Cycles:

Duty	80 Ampere Rating
30%	150 Amperes
40%	125 Amperes
50%	115 Amperes
60%	105 Amperes
70%	95 Amperes

Typical Inductive Fault Currents Which Can Be Ruptured (5ms Time Constant)

Without Blowouts:	500 Amperes at 48V DC
With Blowouts:	500 Amperes at 96V DC

Maximum Recommended Contact Voltages When Direct Current Loads Are to Be Switched

Without Blowouts:	Inductive Load 48V	Resistive Load 60V
With Blowouts:	Inductive Load 96V	Resistive Load 120V

When loads are not switched even under fault conditions, contact voltages may be increased to 250V DC.

Typical Voltage Drop Across New Contacts: 40mV at 80A

Mechanical Life $>3 \times 10^6$

Coil Power Dissipation

Intermittently Rated Types (50% Duty Cycle):	10 - 14 Watts
Continuously Rated Types:	5 - 7 Watts
Magnetically Latched Types:	Initially 12 Watts (0.5 Sec.) Then 0 Watts

Maximum Pull-in Voltage (Coil At 20°C)

Intermittently Rated Types:	60%V
Continuously Rated Types:	66%V

Typical Drop-Out Voltage 10 - 25%

Typical Pull-in Time (N/O Contacts to Close) 15ms

Typical Drop-out time (N/O Contacts to Open)

Without Suppression:	6ms
With Diode Suppression:	35ms

Typical Main Contact Changeover Time (PC61 and SW61)

Normally Closed to Normally Open:	6ms
Normally Open to Normally Closed:	4ms

Typical Contact Bounce Period 3ms

Auxiliary Contact Thermal Current Rating 5 Amperes

Auxiliary Contact Switching Capacity (Resistive Load)

5 at 24V DC	1 at 60V DC
0.5 at 120V DC	0.25 at 240V DC

Connection Diagrams

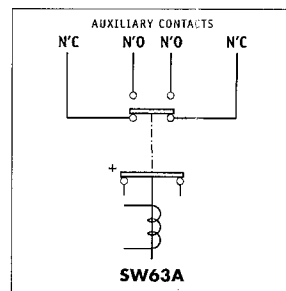
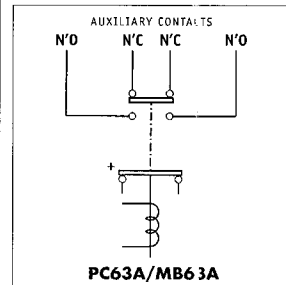
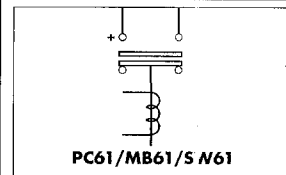
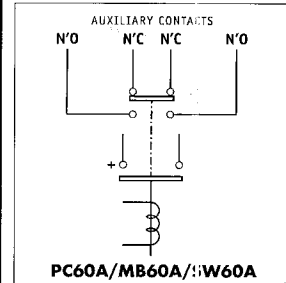

The information contained within this section applies to all PC, MB & SW contactors unless otherwise stated.

Please Note:

All the performance data given here should be used as a guide only. Some derating or variation from these figures may be necessary according to type and application.

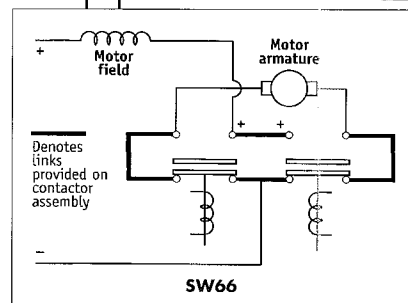

Albright

INTERNATIONAL



GLOBAL INDUSTRIAL PRODUCTS

SPECIALISTS IN ADVANCED
OEM COMPONENT TECHNOLOGIES

20 N. WACKER DRIVE
SUITE 1741
CHICAGO, ILLINOIS 60606 U.S.A.
800.951.8774
FAX 312.251.8776
E-MAIL sales@globalepower.com
www.globalepower.com