

To all our customers

---

## **Regarding the change of names mentioned in the document, such as Mitsubishi Electric and Mitsubishi XX, to Renesas Technology Corp.**

---

The semiconductor operations of Hitachi and Mitsubishi Electric were transferred to Renesas Technology Corporation on April 1st 2003. These operations include microcomputer, logic, analog and discrete devices, and memory chips other than DRAMs (flash memory, SRAMs etc.) Accordingly, although Mitsubishi Electric, Mitsubishi Electric Corporation, Mitsubishi Semiconductors, and other Mitsubishi brand names are mentioned in the document, these names have in fact all been changed to Renesas Technology Corp. Thank you for your understanding. Except for our corporate trademark, logo and corporate statement, no changes whatsoever have been made to the contents of the document, and these changes do not constitute any alteration to the contents of the document itself.

Note : Mitsubishi Electric will continue the business operations of high frequency & optical devices and power devices.

Renesas Technology Corp.  
Customer Support Dept.  
April 1, 2003

**PRELIMINARY**  
 Notice: This is not a final specification.  
 Some parametric limits are subject to change.

MITSUBISHI POWER MOSFET

# FY5AEJ-03

HIGH-SPEED SWITCHING USE  
 Nch/Pch POWER MOSFET

## FY5AEJ-03



- 4V DRIVE
- $V_{DSS}$  .....  $\pm 30V$
- $r_{DS(ON)}$  (MAX) .....  $30/65m\Omega$
- $I_D$  .....  $5/-4A$

## OUTLINE DRAWING

Dimensions in mm

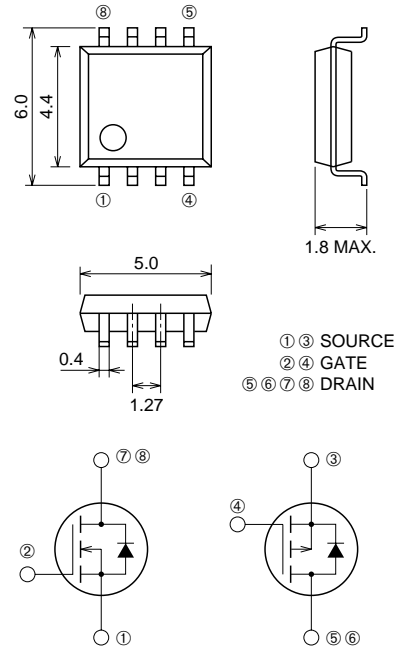

**SOP-8**

## APPLICATION

Motor control, Lamp control, Solenoid control,  
 DC-DC converter, Li-ionbattery, notebook p/c, etc

## MAXIMUM RATINGS ( $T_C = 25^\circ C$ )

Symbol	Parameter	Conditions	Ratings		Unit
			n-ch	p-ch	
$V_{DSS}$	Drain-source voltage	$V_{GS} = 0V$	30	-30	V
$V_{GSS}$	Gate-source voltage	$V_{DS} = 0V$	$\pm 20$	$\pm 20$	V
$I_D$	Drain current		5	-4	A
$I_{DM}$	Drain current (Pulsed)		35	-28	A
$I_{DA}$	Avalanche current (Pulsed)	$L = 10\mu H$	5	-4	A
$I_S$	Source current		1.5	-1.5	A
$I_{SM}$	Source current (Pulsed)		6.0	-6.0	A
$P_D$	Maximum power dissipation		1.6	1.7	W
$T_{ch}$	Channel temperature		-55~+150		$^\circ C$
$T_{stg}$	Storage temperature		-55~+150		$^\circ C$
—	Weight	Typical value	0.07		g

Aug. 1999

**PRELIMINARY**  
Notice: This is not a final specification.  
Some parametric limits are subject to change.

**ELECTRICAL CHARACTERISTICS (Tch = 25°C)**

**N-ch**

Symbol	Parameter	Test conditions	Limits			Unit
			Min.	Typ.	Max.	
V (BR) DSS	Drain-source breakdown voltage	Id = 1mA, VGS = 0V	30	—	—	V
IGSS	Gate-source leakage current	VGS = ±20V, VDS = 0V	—	—	±0.1	μA
IDSS	Drain-source leakage current	VDS = 30V, VGS = 0V	—	—	0.1	mA
VGS (th)	Gate-source threshold voltage	Id = 1mA, VDS = 10V	1.0	1.5	2.0	V
rDS (ON)	Drain-source on-state resistance	Id = 5A, VGS = 10V	—	23	30	mΩ
rDS (ON)	Drain-source on-state resistance	Id = 2A, VGS = 4V	—	40	55	mΩ
yfs	Forward transfer admittance	Id = 5A, VDS = 10V	—	9	—	S
Ciss	Input capacitance	VDS = 10V, VGS = 0V, f = 1MHz	—	550	—	pF
Coss	Output capacitance		—	220	—	pF
Crss	Reverse transfer capacitance		—	115	—	pF
td (on)	Turn-on delay time	VDD = 15V, Id = 2A, VGS = 10V, RGEN = RGS = 50Ω	—	12	—	ns
tr	Rise time		—	20	—	ns
td (off)	Turn-off delay time		—	40	—	ns
tf	Fall time		—	40	—	ns
VSD	Source-drain voltage	IS = 1.5A, VGS = 0V	—	0.75	1.10	V
Rth (ch-a)	Thermal resistance	Channel to ambient	—	—	78.1	°C/W
trr	Reverse recovery time	IS = 1.5A, dis/dt = -50A/μs	—	100	—	ns

**P-ch**

Symbol	Parameter	Test conditions	Limits			Unit
			Min.	Typ.	Max.	
V (BR) DSS	Drain-source breakdown voltage	Id = 1mA, VGS = 0V	-30	—	—	V
IGSS	Gate-source leakage current	VGS = ±20V, VDS = 0V	—	—	±0.1	μA
IDSS	Drain-source leakage current	VDS = -30V, VGS = 0V	—	—	-0.1	mA
VGS (th)	Gate-source threshold voltage	Id = -1mA, VDS = -10V	-1.5	-2.0	-2.5	V
rDS (ON)	Drain-source on-state resistance	Id = -4A, VGS = -10V	—	50	65	mΩ
rDS (ON)	Drain-source on-state resistance	Id = -2A, VGS = -4V	—	90	135	mΩ
yfs	Forward transfer admittance	Id = -4A, VDS = -10V	—	6	—	S
Ciss	Input capacitance	VDS = -10V, VGS = 0V, f = 1MHz	—	870	—	pF
Coss	Output capacitance		—	230	—	pF
Crss	Reverse transfer capacitance		—	110	—	pF
td (on)	Turn-on delay time	VDD = -15V, Id = -2A, VGS = -10V, RGEN = RGS = 50Ω	—	10	—	ns
tr	Rise time		—	10	—	ns
td (off)	Turn-off delay time		—	60	—	ns
tf	Fall time		—	30	—	ns
VSD	Source-drain voltage	IS = -1.5A, VGS = 0V	—	-0.88	-1.20	V
Rth (ch-a)	Thermal resistance	Channel to ambient	—	—	73.5	°C/W
trr	Reverse recovery time	IS = 1.5A, dis/dt = 50A/μs	—	100	—	ns

**PRELIMINARY**  
 Notice: This is not a final specification.  
 Some parametric limits are subject to change.

PERFORMANCE CURVES (N-ch)

POWER DISSIPATION DERATING CURVE

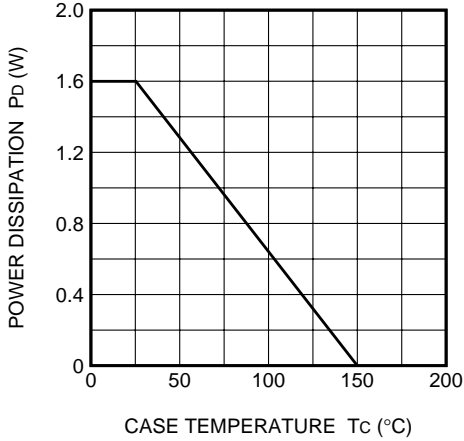

MAXIMUM SAFE OPERATING AREA

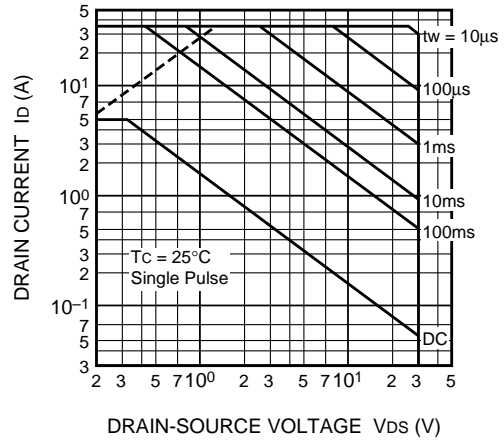

OUTPUT CHARACTERISTICS (TYPICAL)

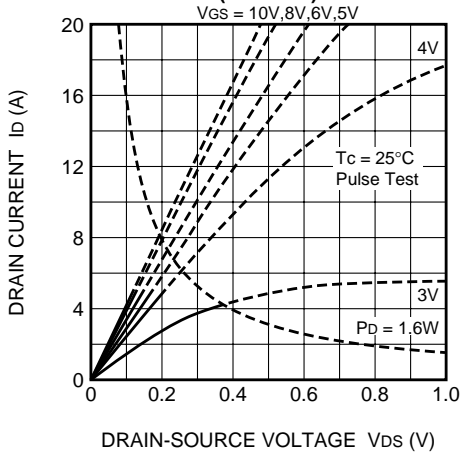

OUTPUT CHARACTERISTICS (TYPICAL)

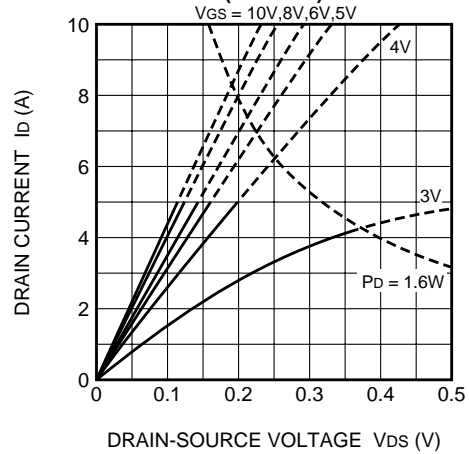

ON-STATE VOLTAGE VS. GATE-SOURCE VOLTAGE (TYPICAL)

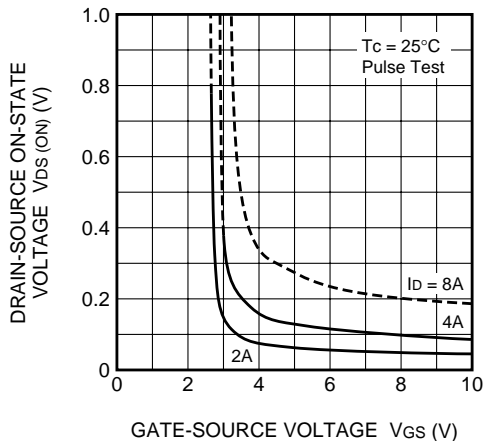

ON-STATE RESISTANCE VS. DRAIN CURRENT (TYPICAL)

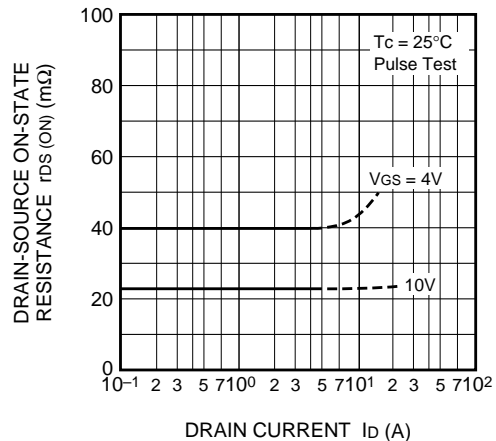

**PRELIMINARY**  
 Notice: This is not a final specification.  
 Some parametric limits are subject to change.

**TRANSFER CHARACTERISTICS (TYPICAL)**

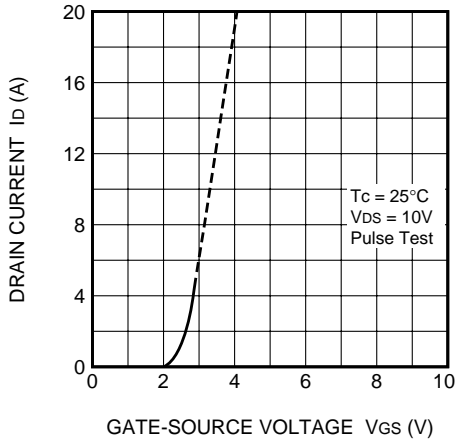

**FORWARD TRANSFER ADMITTANCE VS. DRAIN CURRENT (TYPICAL)**

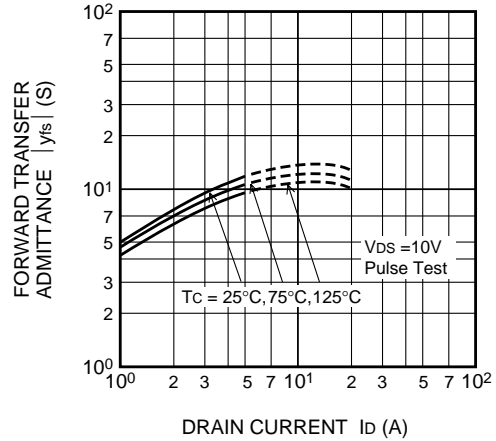

**CAPACITANCE VS. DRAIN-SOURCE VOLTAGE (TYPICAL)**

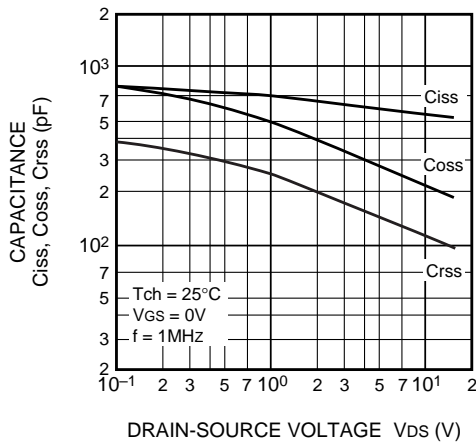

**SWITCHING CHARACTERISTICS (TYPICAL)**

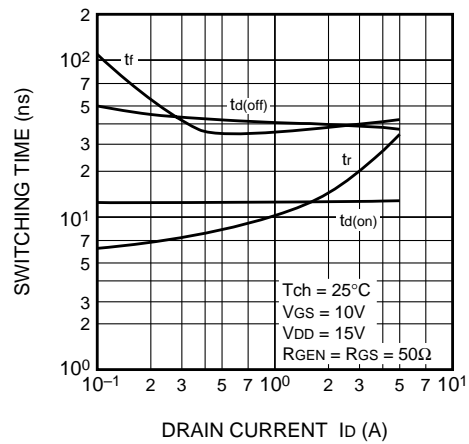

**GATE-SOURCE VOLTAGE VS. GATE CHARGE (TYPICAL)**

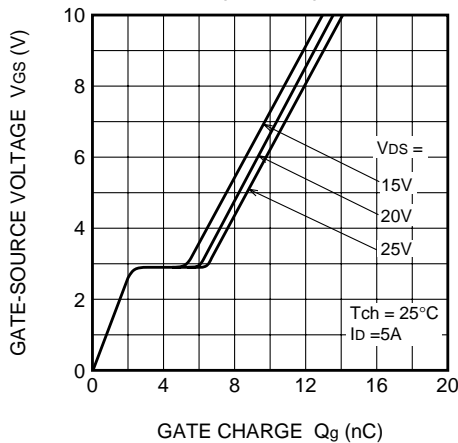

**SOURCE-DRAIN DIODE FORWARD CHARACTERISTICS (TYPICAL)**

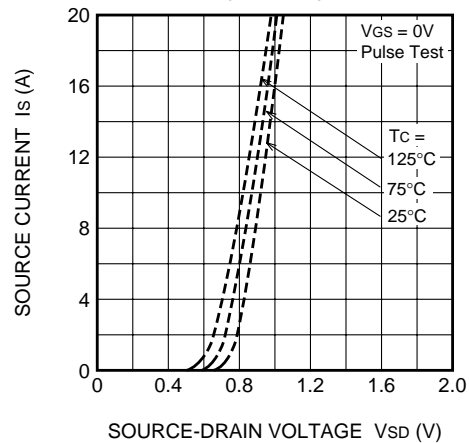

**PRELIMINARY**  
 Notice: This is not a final specification.  
 Some parametric limits are subject to change.

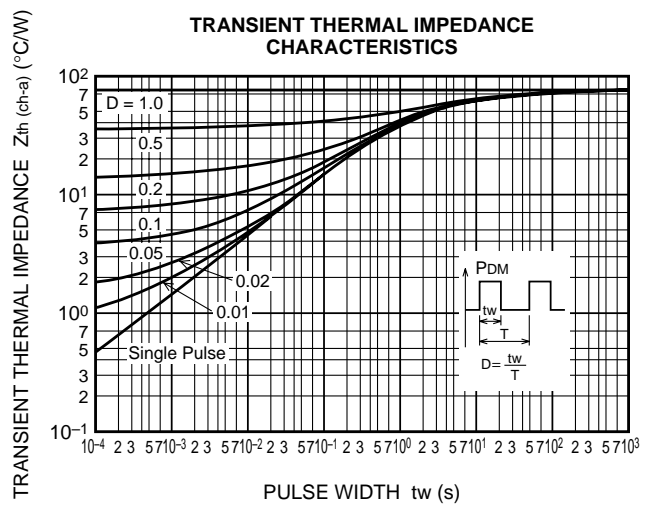
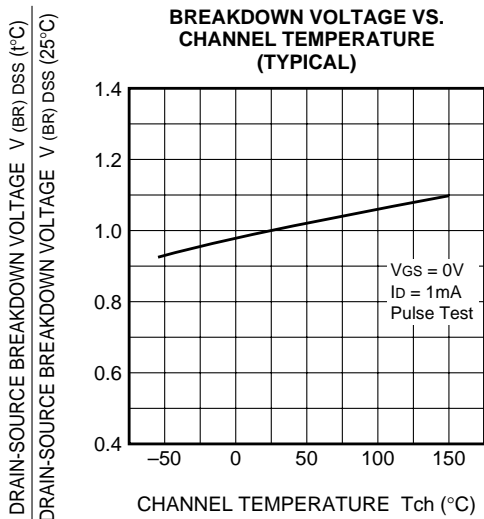
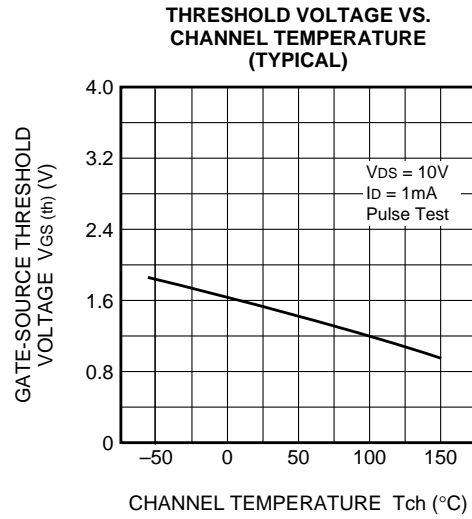
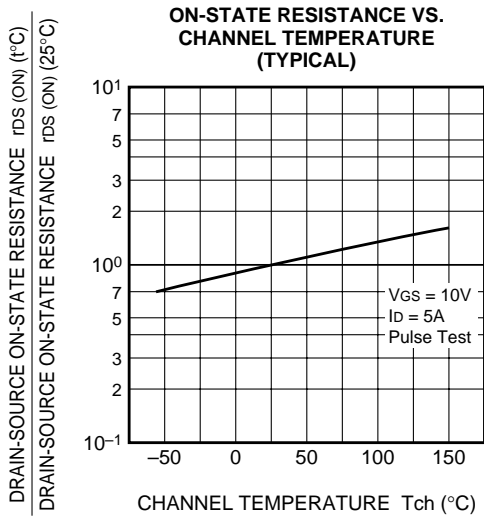

**PRELIMINARY**  
Notice: This is not a final specification.  
Some parametric limits are subject to change.

PERFORMANCE CURVES (P-ch)

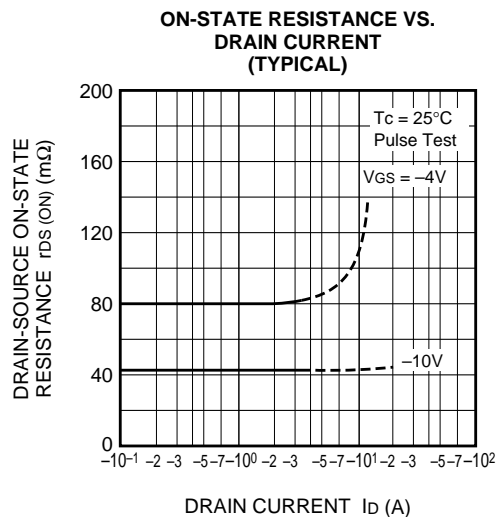
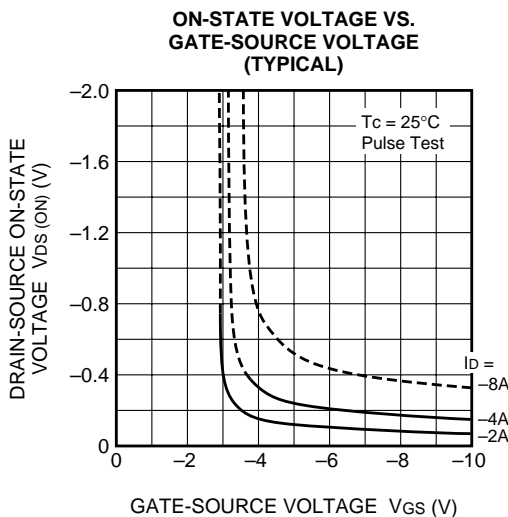
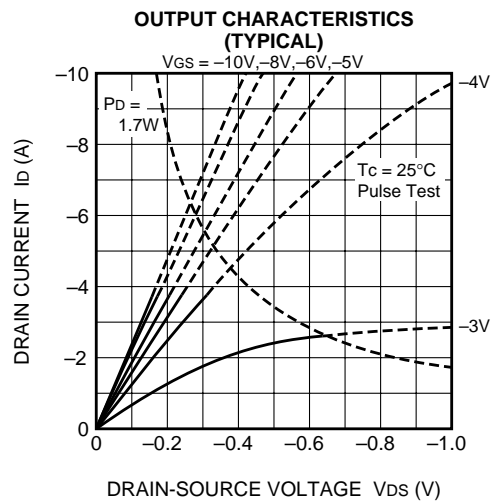
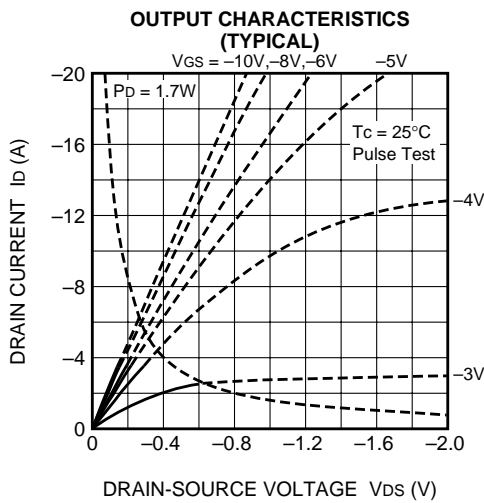
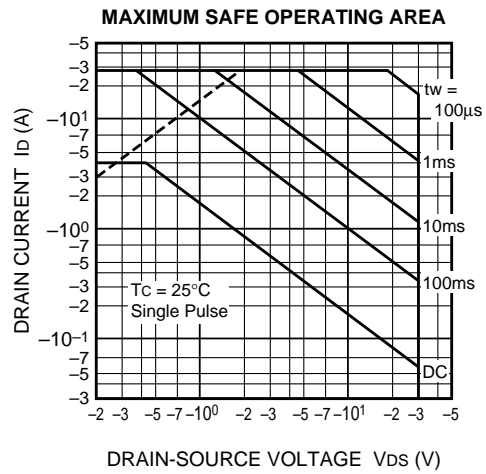
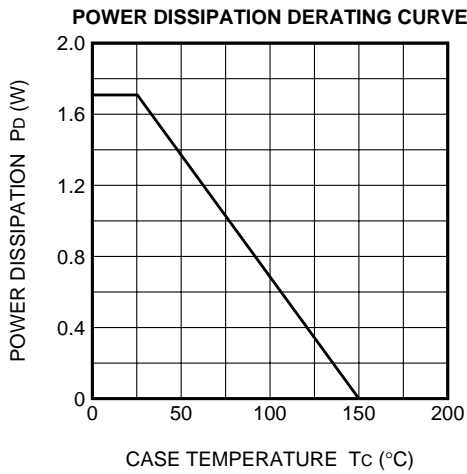

**PRELIMINARY**  
 Notice: This is not a final specification.  
 Some parametric limits are subject to change.

**TRANSFER CHARACTERISTICS (TYPICAL)**

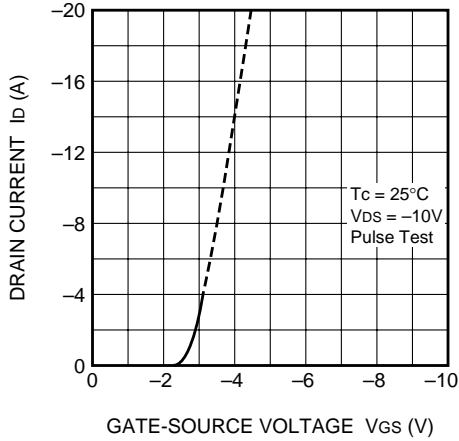

**FORWARD TRANSFER ADMITTANCE VS. DRAIN CURRENT (TYPICAL)**

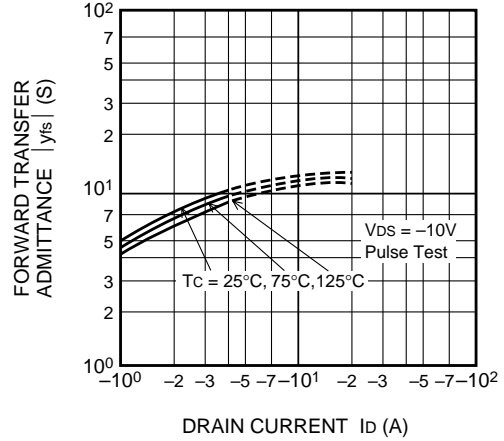

**CAPACITANCE VS. DRAIN-SOURCE VOLTAGE (TYPICAL)**

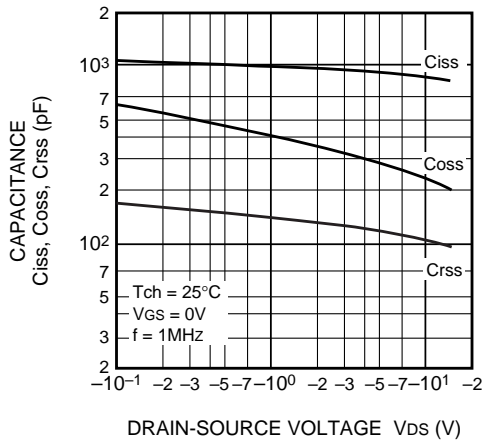

**SWITCHING CHARACTERISTICS (TYPICAL)**

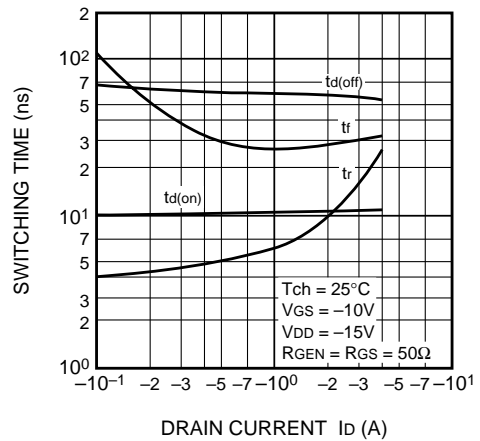

**GATE-SOURCE VOLTAGE VS. GATE CHARGE (TYPICAL)**

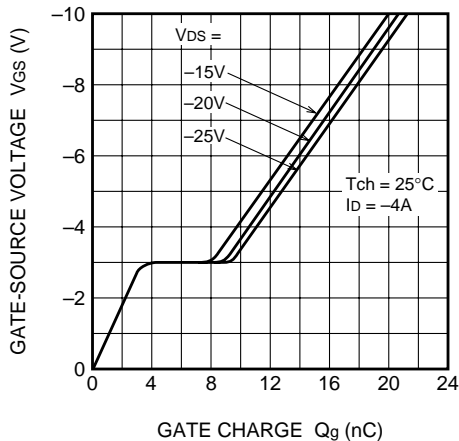

**SOURCE-DRAIN DIODE FORWARD CHARACTERISTICS (TYPICAL)**

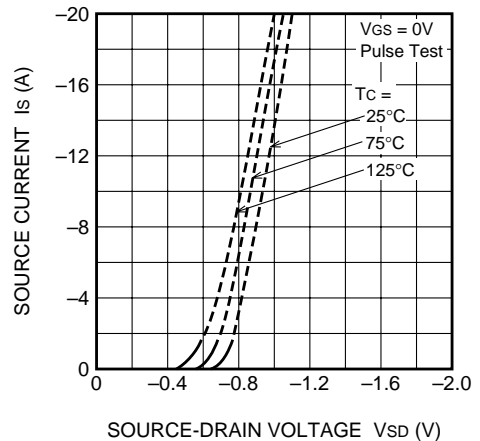



**PRELIMINARY**  
 Notice: This is not a final specification.  
 Some parametric limits are subject to change.

