

# NANOCRYSTALLINE VITROPERM

## EMC PRODUCTS

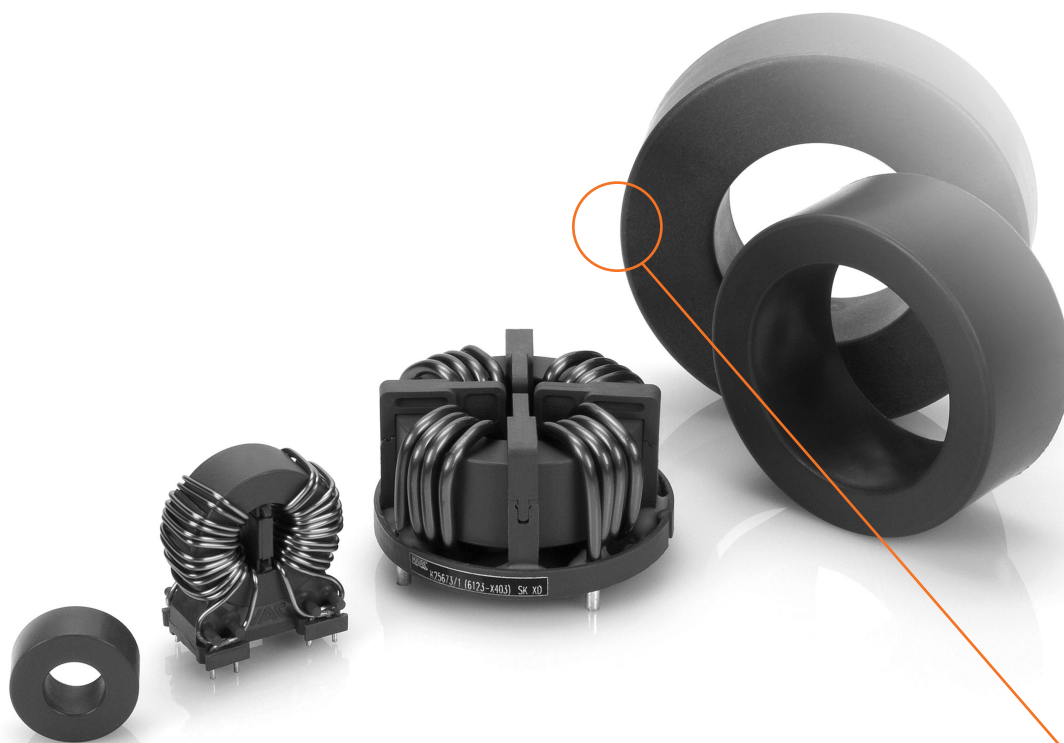

ADVANCED MATERIALS – THE KEY TO PROGRESS

**VAC**  
VACUUMSCHMELZE

# NANOCRYSTALLINE VITROPERM EMC PRODUCTS

VACUUMSCHMELZE GmbH & Co. KG (VAC) is a leading global manufacturer of modern magnetic alloys, cores and inductive components. VAC has supplied innovative solutions for electromagnetic compatibility (EMC) protection for more than 30 years.



# VITROPERM :

## extending the possibilities of iron

Nanocrystalline VITROPERM alloys are based on Fe with Si and B with Nb and Cu additives. VAC pioneered the development of rapid solidification technology resulting in the production of thin tapes or ribbons approximately 20  $\mu\text{m}$  thick. Special slitting and core winding machines produce tape-wound cores with external diameters ranging from 2 mm to 600 mm. A subsequent heat treatment at around 500 – 600  $^{\circ}\text{C}$  transforms the initially amorphous microstructure of the tape into the desired nanocrystalline state. This being a two-phase structure with fine crystalline grains (average grain diameter of 10-40 nm) embedded in an amorphous residual phase.

VITROPERM nanocrystalline alloys are optimized to combine highest permeability and lowest coercive field strength. The combination of very thin tapes and the relatively high electrical resistance (1.1 – 1.2  $\mu\Omega\text{m}$ ) ensure minimal eddy current losses and an outstanding frequency vs. permeability behaviour. Along with saturation flux density of 1.2 T and wide operational temperature range, these features combine to make VITROPERM a universal solution for most common EMC problems and vastly superior in many aspects to commonly used ferrite and amorphous iron materials.

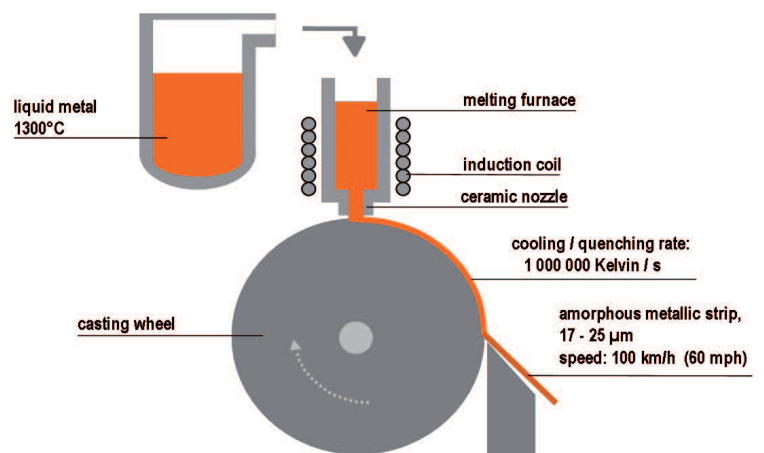

Fig. 1: Rapid solidification technology is used to produce thin metal tapes with an amorphous structure (metallic glass).

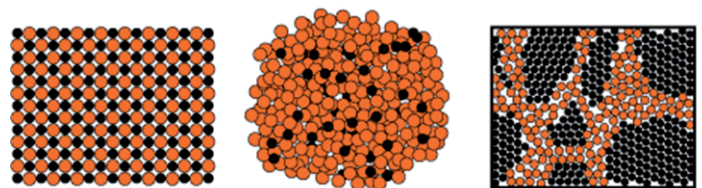

Fig 2: Crystalline structure, amorphous structure, nanocrystalline microstructure

# COMMON MODE CHOKES & tape-wound cores

Nanocrystalline cores are widely used in common mode choke (CMC) applications due to their unique combination of properties. By utilising low-cost raw materials (Fe-based) and modern, large-scale production, VITROPERM is a very competitive solution for a wide range of applications. Key areas of application are:

- Switched-mode power supplies (SMPS)
- Solar inverters
- Frequency converters
- EMC filters
- Welding equipment
- Wind generators
- Induction hobs
- Automotive applications
- Uninterruptable power supplies (UPS)

Our CMCs feature high attenuation which is maintained across a wide frequency range offering extremely broadband attenuation. In many cases, this characteristic can allow a reduction of the number of filter stages in multistage EMC filter configurations to reduce complexity, cost and filter volume. Ohmic (copper) losses are also reduced increasing the efficiency and lowering component temperature.

Standard 2-stage EMI-Filter    Optimized 1-stage EMC-Filter with VITROPERM

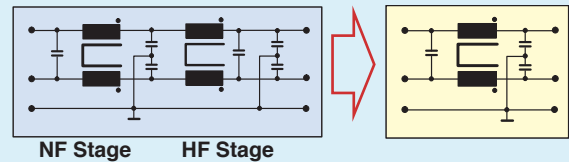

Fig. 3: Nanocrystalline chokes allow a reduction of filter stages

VACUUMSCHMELZE has extensive practical and theoretical expertise in the design of CMCs and filter configuration using nanocrystalline cores and components. At higher frequencies, the winding configuration has a major effect on the parameters of winding capacitance and leakage inductance and is therefore carefully considered in our choke designs. Figure 4 shows a comparison of insertion loss for two chokes which differ only in their winding configuration (core material, number of turns and wire thickness are identical in both cases). This illustrates how our design expertise can improve filter efficiency, maximize reliability and reduce costs.

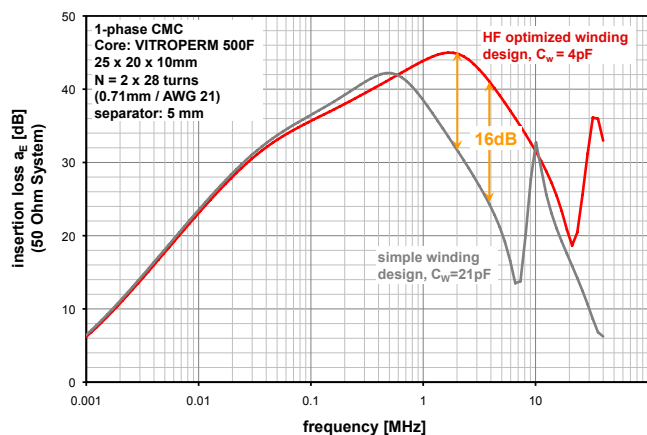

Fig. 4 : Optimized choke design: improved attenuation of up to 16 dB (or more) at 4 MHz.

# Features & benefits of VITROPERM nanocrystalline chokes



- Small size
- Suitable for high currents and/or high voltages
- Single stage filter designs possible
- High efficiency, low power loss
- "Green", environmentally friendly
- Suitable for high and low ambient temperatures and high operating temperatures
- "Easy filter design"
- UL-compliant designs
- Optimized solutions for a variety of different applications
- No operating noise
- Best suited for winding of thick wires

High  $\mu$ , high  $B_s$

High  $\mu$ , high  $B_s$ , suitable core geometries

Extremely broadband attenuation behaviour, high permeability, low-capacitance design, moderate reduction of  $\mu$  up to high frequencies, low Q-factor in 150 kHz range

Low number of turns required for high L, reduction of filter stages

Low power loss, reduced use of material

High Curie temperature, material properties ( $\mu$ ,  $B_s$ ,  $\lambda_s$ ) nearly independent of temperature

Material properties ( $\mu$ ,  $B_s$ ,  $\lambda_s$ ) nearly independent of temperature, linear magnetization curve delivers stable impedance across a broad range of common mode currents – VAC choke design software available

Suitable plastic materials meet UL1446 insulation requirements

A range of  $\mu$  levels and VITROPERM alloys available

Material is practically magnetostriction-free

Material is practically magnetostriction-free, coatings/casings are resistant against mechanical stress

# VITROPERM

## vs. ferrite

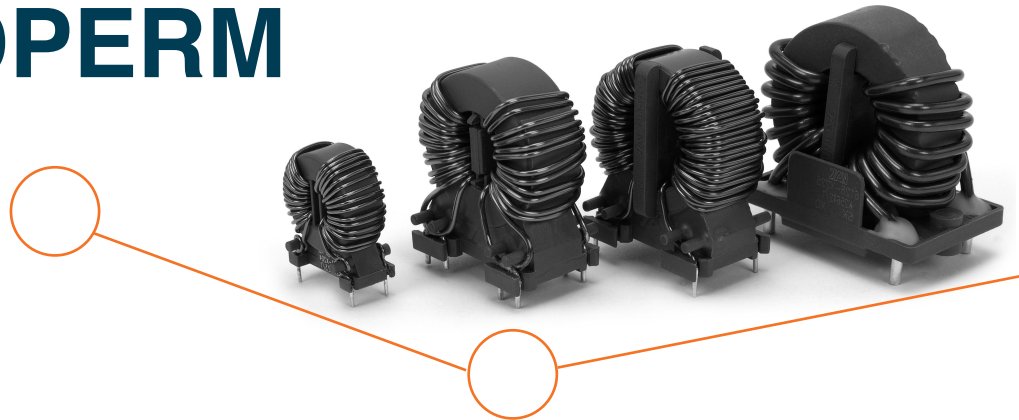

Due to the optimized high-frequency properties the insertion loss of our nanocrystalline common mode chokes is superior compared to that of a typical ferrite choke in the relevant frequency range.

The properties of VITROPERM are very much different from conventional ferrites. This has to be considered in the filter design for optimal solutions. The main physical and magnetic characteristics are illustrated in the following diagrams.

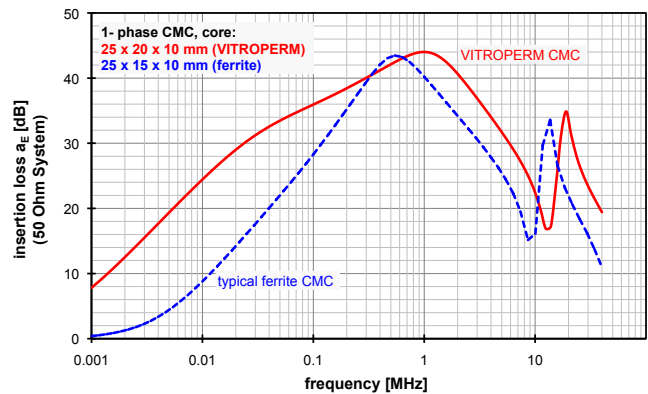

Fig 5: Comparison of insertion loss of VITROPERM and ferrite

The permeability of VITROPERM 500F is significantly higher than ferrite in the low frequency range. At higher frequencies the  $\mu$  of both nanocrystalline materials remains above that of ferrites. A high choke impedance is preferred for a high attenuation. This can be achieved more effectively by using high permeability core materials than by increasing the number of turns, as a lower number of turns results in lower winding capacitance and hence improved HF properties.

### permeability

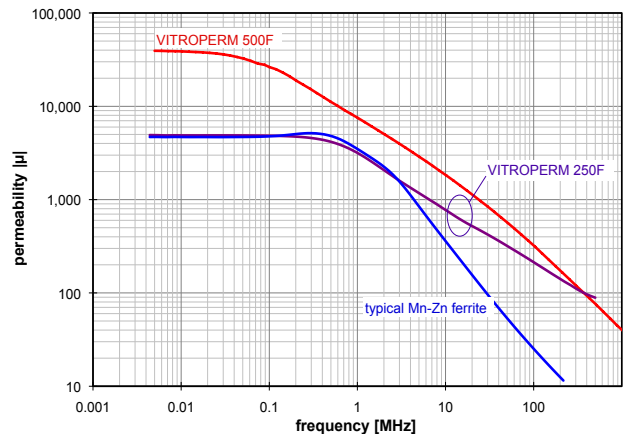

Fig 6: Frequency response of the permeability of VITROPERM 500F ( $\mu=40\ 000$ ) and VITROPERM 250F ( $\mu=5\ 000$ ) in comparison to a typical MnZn ferrite ( $\mu=5\ 000$ ).

# Permeability & magnetization curve

The frequency dependence of the permeability,  $\mu(f)$  of VITROPERM 500F and ferrites differ fundamentally.  $\mu(f)$  of  $\mu=5\,000$  ferrites offer a flat and linear characteristic up to approximately 1 MHz (ferrites with  $\mu=10\,000$  range up to approximately 200 kHz). In this flat range, the attenuation properties are determined by  $\mu'$  and the impedance  $|Z|$  is dominated by the inductance  $L$ . If the self resonance of the choke is within this frequency range, the attenuation curve is narrow-band and attenuation is primarily caused by reflection of the interference signal. Above 1 MHz (or 200 kHz)  $\text{Re}(Z)$  takes the major share of attenuation and  $\mu''$  becomes the dominant factor. If the self resonance of the choke is in this frequency range the attenuation characteristic becomes increasingly broadband.

VITROPERM is basically similar in this respect. The flat sector of  $\mu(f)$  of VITROPERM 500F ranges (depending on the initial permeability level) to frequencies of several 10 kHz (20 kHz in this example), only. Consequently, attenuation (or  $|Z|$ ) is already dominated by  $\text{Re}(Z)$  and is always broadband in the whole EMC-relevant range above 150 kHz. Inductance plays a minor role and describes the attenuation only partially. The determining factor is the total impedance. The approximation  $|Z|=\omega L$  is valid for ferrite chokes. For VITROPERM chokes  $|Z|\gg\omega L$  applies. Attenuation primarily does not result from a reflection of the interference signal, but from its absorption.

It is only when these different characteristics are taken into consideration that the design of optimized, compact and low-cost nanocrystalline chokes is possible. However, VITROPERM 250F is an exception, because the flat  $\mu(f)$  sector range is similar to  $\mu=5\,000$  ferrites to frequencies of up to 1 MHz and the attenuation is primarily inductive.

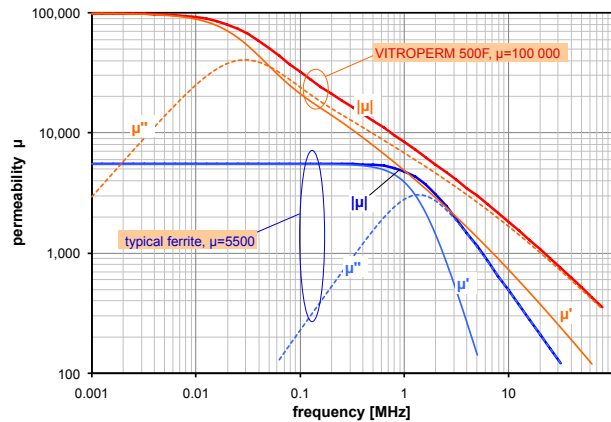

Fig. 7: Differences in the balance between  $\mu'$  and  $\mu''$  for VITROPERM and ferrite lead to different attenuation mechanisms

## magnetization curve

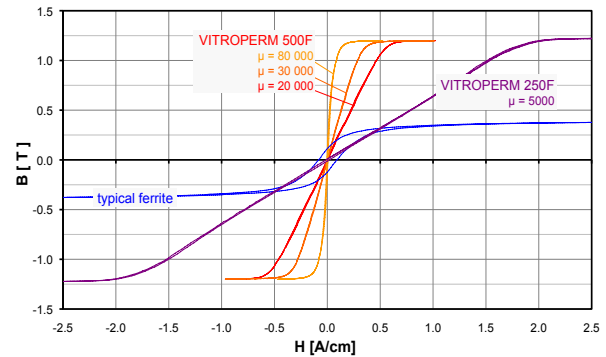

Fig. 8a: Hysteresis loops for various types of VITROPERM and typical MnZn ferrite.

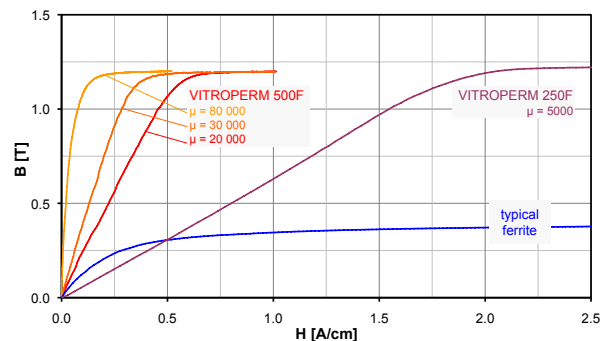

Fig. 8b: Magnetization curve of VITROPERM 500F and VITROPERM 250F in comparison to typical MnZn ferrite, showing noticeable differences in permeability (slope of the curve) and saturation flux density ( $B_S$ )

# Thermal properties

The saturation flux density of VITROPERM changes by only a few percent in the operating temperature range of up to 150 °C, while MnZn ferrites decline up to 40 % at temperatures above 100 °C. The high Curie temperature of VITROPERM alloys (above 600 °C), allows short term maximum operating temperatures as high as 180 – 200 °C<sup>1)</sup>.

<sup>1)</sup> Maximum continuous temperature depends on the casing / coating materials used. Please contact VAC for more detailed information.

The permeability of VITROPERM typically changes by less than 10 % in the temperature range from -40 °C to 120 °C, while the permeability of MnZn ferrites can drift in a range of ± 40 – 60 % around the room temperature value.

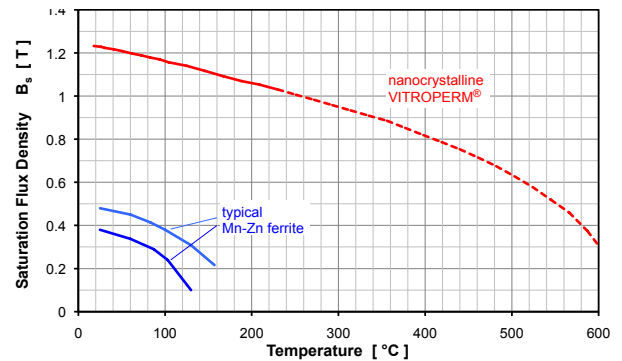

Fig. 9: Temperature dependence of saturation flux density  $B_s(T)$

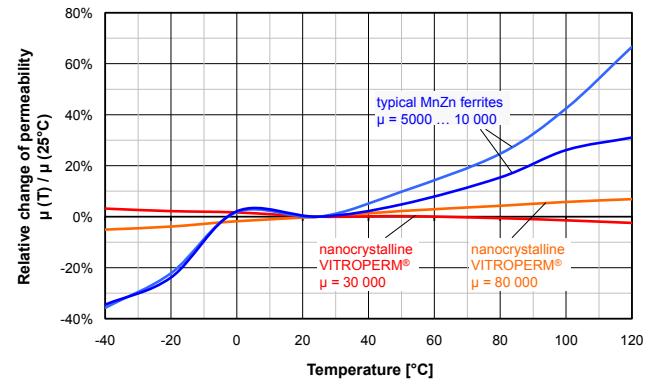

Fig. 10: Relative change of  $\mu(T)$  at  $f = 100$  kHz, normalized for room temperature

Insertion loss (and impedance) of a CMC made of VITROPERM 500F is almost temperature-independent in the temperature range of -40 °C to above 150 °C. In contrast, ferrite chokes feature a significant drop of insertion loss with increasing temperature.

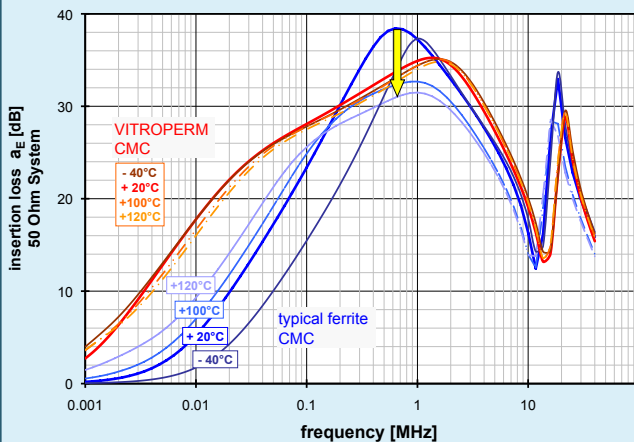

Fig. 11a: Comparison of temperature dependence of insertion loss of a VITROPERM CMC and a choke with standard MnZn ferrite core

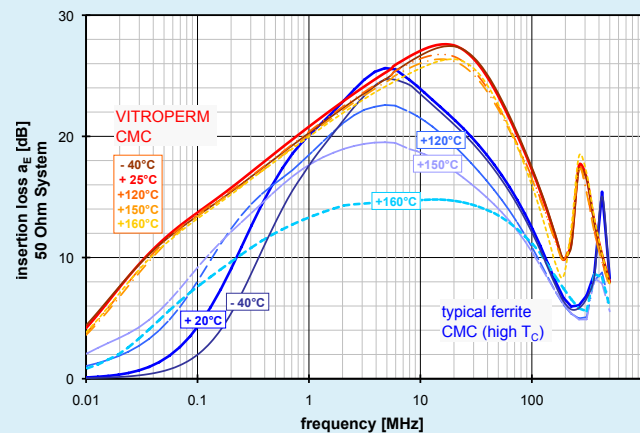

Fig. 11b: Comparison of temperature dependence of insertion loss up to 160 °C of a VITROPERM CMC and a MnZn choke using a high Curie temperature ferrite material



# Saturation behaviour

High permeability nanocrystalline cores enable very high inductance levels in extremely compact core or choke dimensions. However, as a consequence an increased sensitivity to asymmetric magnetization conditions caused by common mode, unbalanced or leakage currents has to be considered. These currents may occur as low-frequency leakage currents (50 Hz) or as medium or high-frequency interference currents. These are caused for example by long motor cables with different capacitance of the individual conductors to earth, or by resonances which occur (commonly due to bearing currents) in such cables leading to short, extremely high and rapidly declining current peaks with amplitudes of up to several  $10 A_{peak}$  and pulse widths in the nanosecond range (1 ... several 100 ns). If these common mode currents exceed the saturation level of the choke or core, the attenuation of the choke breaks down and the choke becomes less effective.

The saturation behaviour of ferrite is less sensitive due to its lower permeability. For applications with higher imbalance currents, the advantages of VITROPERM with 1.2 T saturation flux density (approximately 3 times higher than ferrites) can still be realised since VITROPERM is available in a range of permeability levels between 4 000 and 150 000. In these cases, a lower  $\mu$  level may have to be selected in order to find the optimum saturation-resistant solution. Fig. 12a shows a comparison of saturation currents for different VITROPERM designs with a typical ferrite core of similar dimensions. It can be seen that the saturation behaviour of the MnZn ferrite ( $\mu=6\ 000$ ) is comparable with that of VITROPERM 500F ( $\mu=17\ 000$ ) up to frequencies of approximately 50 kHz. At higher frequencies, however, the VITROPERM design is becoming more advantageous. The VITROPERM solution offers a 50 % higher  $A_L$  value at 100 kHz and a significantly higher impedance (note that the impedance of VITROPERM is determined to a small part by inductance  $L$  in this frequency range). High permeability VITROPERM 500F cores are characterized by an extremely high attenuation or impedance at low frequencies, and they are clearly superior against ferrites at high frequencies. However, the price of this superior performance is a more sensitive saturation behaviour, which is improving with increasing frequency but still more critical than that of other core materials. It should be noted that Fig. 12a shows the saturation currents of the cores without winding. Depending on the number of turns, the  $I_{CM}$  values of chokes are some 10 mA to several 100 mA, only (see tables of standard series).

Fig. 12b shows permeability characteristics under DC bias field for a VITROPERM 500F core ( $\mu=20\ 000$ ) and 2 typical MnZn ferrites ( $\mu=5\ 000$  and  $\mu=8\ 000$ , respectively). The diagram shows the significantly higher permeability and a square  $\mu(H_{DC})$  characteristic of the nanocrystalline material in comparison to the rounded properties of the two ferrite cores. This behaviour complies to the linear magnetization curve of VITROPERM (Figs. 8a / 8b) and leads to nearly constant inductance over a wide range of the DC bias fields.

VITROPERM 250F is always used where highly saturation-resistant solutions are required for applications with very high common mode or unbalanced currents. However, it cannot equal the high attenuation of VITROPERM 500F.

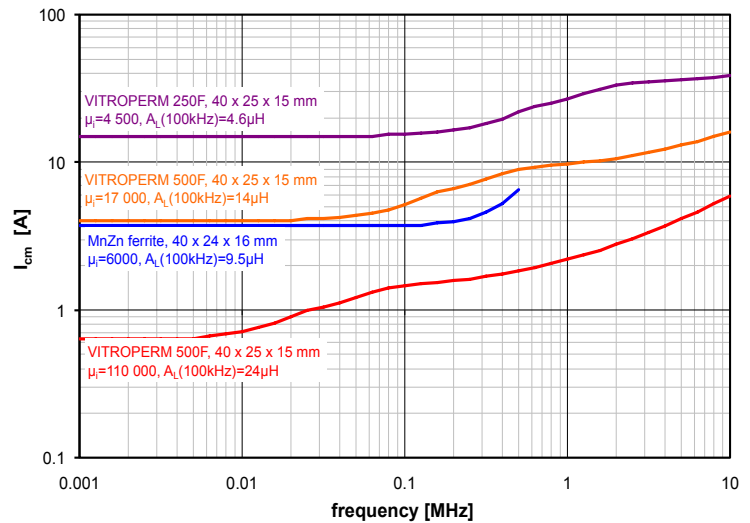

Fig. 12a: Comparison of saturation behaviour of VITROPERM 500F, VITROPERM 250F and MnZn ferrite

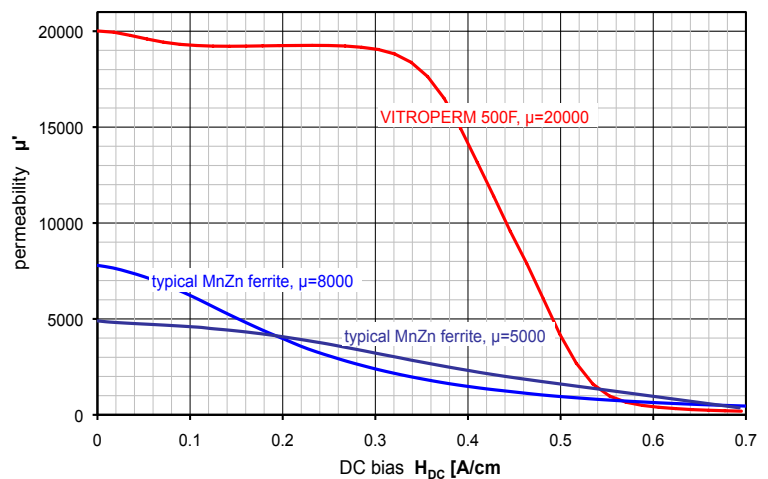

Fig. 12b: Comparison of permeability characteristics under DC bias fields for VITROPERM 500F and two typical MnZn ferrites.

# Design advantages with VITROPERM

The superior material properties of nanocrystalline VITROPERM enable common mode chokes with high inductance/impedance with a small number of turns, resulting in reduced copper losses, low winding capacitance and excellent HF performance.

Due to the high initial permeability, low winding capacitance and a low Q-factor (above 100 kHz) VITROPERM CMCs offer a broadband insertion loss curve ranging from 10 kHz up to several MHz and improved attenuation behaviour at both low and high frequencies in comparison to conventional ferrite chokes with similar core dimensions and identical windings (see Fig. 13).

Better attenuation properties and an extended operating temperature range allow a reduction of the component volume by a factor of up to 3 or more under similar conditions. Note that the insertion loss curve of the small VITROPERM choke in Fig. 14 is similar to that of ferrite materials at frequencies of about 600 kHz – 1 MHz and is superior below 500 kHz and above 1 MHz.

The excellent attenuation of VITROPERM CMCs simplifies the filter design in a wide frequency range. For laboratory tests, VAC offers different sample kits with selected standard cores and chokes.

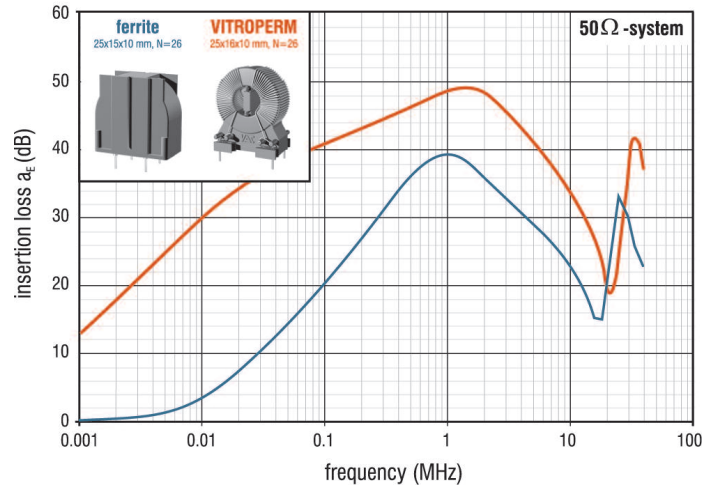

Fig. 13: Comparison of insertion loss curve of a VITROPERM 500F CMC (red curve) and ferrite CMC (blue curve) of similar size and with the same number of turns.

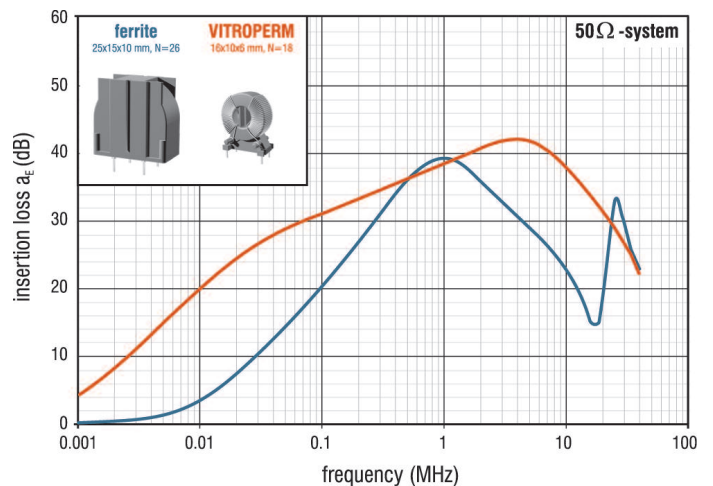

Fig. 14: Comparison of the dimensions of a VITROPERM 500F CMC (red curve) and ferrite CMC (blue curve) with similar attenuation properties in the 1 MHz range

## VITROPERM – typical data

Saturation flux density	$B_S = 1.2 \text{ T}$
Coercivity (static)	$H_C < 3 \text{ A/m}$
Saturation magnetostriction	$\lambda_S =$
VITROPERM 500F	$10^{-8} \dots 10^{-6}$
VITROPERM 250F	$\approx 8 \times 10^{-6}$
Specific electrical resistance	$\approx 115 \mu\Omega\text{cm}$
Curie temperature	$T_C > 600 \text{ }^\circ\text{C}$

Max. operational temperature	$T_{\text{max}} =$
Continuous-epoxy	$120 \text{ }^\circ\text{C}^{1)}$
Continuous-plastic casing	$130/155 \text{ }^\circ\text{C}^{1)}$
short-term	$180 \text{ }^\circ\text{C}^{1)}$
Permeability	$\mu_i =$
VITROPERM 500F	$15\ 000 \dots 150\ 000$
VITROPERM 250F	$4\ 000 \dots 6\ 000$
Core losses (100 kHz, 0.3 T)	$P_{Fe} = 80 \text{ W/kg (typ.)}$

<sup>1)</sup> Please contact VAC for more detailed information about the temperature limits of our casing and coating materials.



# STANDARD SERIES OF VITROPERM CORES

Our VITROPERM cores are available with different  $A_L$ -levels for many core sizes. Thus, saturation-resistant solutions are available for various fields of applications. Common mode currents may occur as interference currents, bias currents or, primarily, unbalanced currents. If the common mode currents exceed the saturation currents ( $I_{cm}$ ) of the cores or chokes, cores with higher saturation resistance must be used. High  $A_L$  values (high  $\mu$ ) are more suitable for typical single-phase applications with low unbalanced current (e.g. switched-mode power supplies), while cores with lower  $A_L$  values are often used in 3-phase applications with high unbalanced currents (e.g. frequency converters with long motor cables).

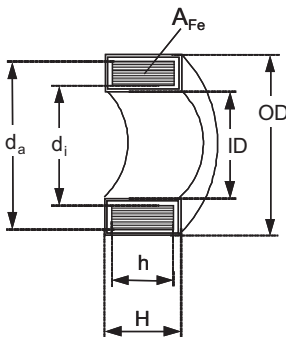

## Nanocrystalline VITROPERM cores with epoxy resin coating

Although the epoxy resin coating is suitable for direct winding, we recommend additional insulation between core and winding for enhanced insulation requirements. The epoxy resin is suitable for continuous operational temperatures of up to 120 °C and complies with the UL94-V0 standard (UL file number: E214934), class A (105 °C).

nominal core dimensions $d_a \times d_i \times h$ mm x mm x mm	limiting dimensions (incl. coating)			iron cross section $A_{Fe}$ cm <sup>2</sup>	mean path length $l_{Fe}$ cm	weight $m_{Fe}$ g	$A_L$		saturation current $I_{cm}^{**}$ , typical		part number
	OD mm	ID mm	H mm				10 kHz nominal $\mu H$	100 kHz nominal $\mu H$	10 kHz A	100 kHz A	
16 x 12.5 x 6	17,8	10,7	8	0,08	4,5	2,6 2,6	15,0 6,0	4,8 3,9	0,5 1,1	0,8 1,7	T60004-L2016-W620 T60004-L2016-W619
22 x 17 x 6	24,0	15,2	8,0	0,12	6,1	5,4	16,4	4,3	0,6	1,2	T60004-L2022-W867
25 x 20 x 10	27,3	17,5	12,3	0,19	7,1	9,9 9,9	22,5 9,0	7,2 5,8	0,7 1,7	1,4 2,7	T60004-L2025-W622 T60004-L2025-W621
30 x 25 x 15	32,3	22,7	17,5	0,27	8,6	17,4	26,5	8,5	0,9	1,7	T60004-L2030-W676
30 x 20 x 10	32,5	17,8	12,5	0,40	7,9	23,1	56,0	13,4	0,6	1,2	T60004-L2030-W911
40 x 32 x 15	42,3	29,1	17,8	0,44	11,3	36 36	32,5 13,0	10,3 8,4	1,1 2,8	2,2 4,3	T60004-L2040-W624 T60004-L2040-W623
45 x 32 x 15	47,3	29,8	17,8	0,71	12,1	63,3	19,7	12,8	3,0	4,6	T60004-L2045-W886
50 x 40 x 20	52,3	37,1	22,8	0,73	14,1	76 76	43,0 17,0	13,8 11,2	1,4 3,6	2,7 5,4	T60004-L2050-W626 T60004-L2050-W625
63 x 50 x 20	65,5	46,6	22,8	0,95	17,8	124 124	18,0 11,5	11,6 10,4	4,4 6,9	6,7 8,7	T60004-L2063-W627 T60004-L2063-W721
80 x 63 x 20	83	59,5	22,8	1,24	22,5	205 205	18,5 11,9	12,0 10,7	5,6 8,7	8,5 11,0	T60004-L2080-W628 T60004-L2080-W722
100 x 80 x 20	104	75	23	1,46	28,3	303 303	17,3 11,2	11,2 10,0	7,1 10,9	10,7 13,8	T60004-L2100-W629 T60004-L2100-W723
130 x 100 x 25	134,5	95,0	28,5	2,85 2,74 2,74	36,1 36,1 36,1	757 727 727	50,0 25,4 16,4	19,4 16,5 14,7	4,8 9,0 14,0	8,5 13,6 17,7	T60004-L2130-W567 T60004-L2130-W630 T60004-L2130-W587
160 x 130 x 25	165	125	28,5	2,74	45,6	917 917	20,1 13,0	13,1 11,7	11,3 17,6	17,1 22,3	T60004-L2160-W631 T60004-L2160-W720
194 x 155 x 25	200	149	28,5	3,71	54,8	1490 1490	45,3 14,7	14,7 13,2	6,9 20,7	12,5 26,4	T60004-L2194-V105 T60004-L2194-W908



## Nanocrystalline VITROPERM cores in plastic casing

The plastic cases are suitable for direct winding and offer good mechanical protection of the nanocrystalline core material. This enables the best magnetic properties and highest permeability levels to be maintained. Additional winding protection is optional for heavy wire windings, where there may be a danger of core damage. The plastic materials comply with the standards UL94-V0 (UL file number: E41871), class B (130 °C) and UL94-V0 (UL file number E41938), class F (155 °C).

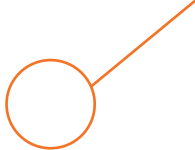

nominal core dimensions d <sub>a</sub> x d <sub>i</sub> x h mm x mm x mm	limiting dimensions (incl. case)			iron cross section A <sub>Fo</sub> cm <sup>2</sup>	mean path length l <sub>Fo</sub> cm	weight m <sub>Fo</sub> g	A <sub>L</sub> *		saturation current I <sub>cm</sub> **, typical		part number
	OD	ID	H				10 kHz	100 kHz	10 kHz	100 kHz	
9.8 x 6.5 x 4.5	11,2	5,1	5,8	0,06	2,6	1,1	25,5	6,4	0,2	0,4	T60006-L2009-W914
12 x 8 x 4.5	14,1	6,6	6,3	0,07	3,1	1,7	28,0	6,8	0,2	0,4	T60006-L2012-W902
12.5 x 10 x 5	14,3	8,5	7,0	0,05	3,5	1,3	10,0	3,6	0,4	0,8	T60006-L2012-W498
15 x 10 x 4.5	17,1	7,9	6,5	0,09	3,9	2,6	27,0	6,7	0,3	0,5	T60006-L2015-W865
16 x 10 x 6	17,9	8,1	8,1	0,14	4,1	4	43,0	10,1	0,3	0,6	T60006-L2016-W403
						4	11,7	6,5	1,2	1,7	T60006-L2016-W308
17.5 x 12.6 x 6	19,0	11,0	8,0	0,12	4,7	4,1	30,0	6,9	0,3	0,7	T60006-L2017-W515
19 x 15 x 10	21,2	13,0	12,3	0,16	5,3	6,3	36,1	8,8	0,4	0,7	T60006-L2019-W838
20 x 12.5 x 8	22,6	10,3	10,2	0,24	5,1	9,0	55,2	13,6	0,4	0,7	T60006-L2020-W409
						9,0	14,3	9,1	1,4	2,1	T60006-L2020-W450
25 x 20 x 10	27,6	17,4	12,8	0,20	7,1	10,4	28,4	7,3	0,6	1,1	T60006-L2025-W523
25 x 16 x 10	27,9	13,6	12,5	0,36	6,4	17	65,5	15,5	0,4	0,9	T60006-L2025-W380
						17	17,0	11,5	1,7	2,6	T60006-L2025-W451
						17	3,2	3,1	9,3	9,6	T60006-L2025-W980
30 x 20 x 10	32,8	17,6	12,5	0,40	7,9	23	59,3	14,0	0,5	1,0	T60006-L2030-W423
						23	15,5	11,1	2,1	3,1	T60006-L2030-W358
						23	2,9	2,8	11,4	11,8	T60006-L2030-W981
30 x 20 x 15	32,8	17,5	17,8	0,57	7,9	33	88,0	20,0	0,5	1,1	T60006-L2030-W514
40 x 32 x 15	43,1	28,7	18,5	0,46	11,3	38	47,2	11,1	0,8	1,5	T60006-L2040-W422
						38	12,2	7,9	3,7	5,1	T60006-L2040-W452
						38	2,3	2,2	16,6	17,1	T60006-L2040-W964
40 x 25 x 15	43,1	22,5	18,5	0,86	10,2	64	101,0	23,1	0,7	1,4	T60006-L2040-W424
						64	25,4	17,2	2,9	4,2	T60006-L2040-W453
45 x 30 x 15	48,3	26,4	18,2	0,86	11,8	74	87,5	20,3	0,8	1,6	T60006-L2045-V102
						74	24,3	15,9	3,0	4,5	T60006-L2045-V118
						74	15,7	14,3	4,6	5,8	T60006-L2045-V101
50 x 40 x 20	53,5	36,3	23,4	0,76	14,1	79	45,3	14,0	1,4	2,7	T60006-L2050-W516
						79	18,0	10,0	3,5	5,3	T60006-L2050-W565
63 x 50 x 25	67,3	46,5	28,6	1,24	17,8	161	58,6	18,1	1,8	3,5	T60006-L2063-W517
						161	23,3	13,5	4,4	6,7	T60006-L2063-V110
						163	3,3	3,2	30,2	30,9	T60006-L2063-W985
80 x 50 x 20	86,0	44,7	25,7	2,28	20,4	342	35,0	24,0	5,5	8,2	T60006-L2080-W531
						347	9,6	9,2	26,4	27,3	T60006-L2080-V091
90 x 60 x 20	95,4	54,7	24,7	2,28	23,6	395	81,0	25,1	2,4	4,5	T60006-L2090-W518
						400	4,6	4,5	40,9	41,8	T60006-L2090-W984
100 x 80 x 25	105,5	75,0	29,6	1,90	28,3	379	56,3	16,9	2,8	5,3	T60006-L2100-V082
						379	14,5	13,1	10,9	13,8	T60006-L2100-V081
102 x 76 x 25	108,1	70,0	30,3	2,47	28,0	508	68,8	21,6	3,8	6,7	T60006-L2102-W468
						508	19,1	17,2	10,7	13,6	T60006-L2102-V080
						515	4,3	4,2	47,4	48,5	T60006-L2102-W947
160 x 130 x 25	166,9	123,9	30,5	2,74	45,6	917	26,8	13,7	8,4	13,6	T60006-L2160-V074
				2,74	45,6	917	20,1	13,1	11,3	17,1	T60006-L2160-V088
				2,74	45,6	917	12,9	11,7	17,6	22,3	T60006-L2160-V066
				2,85	45,6	967	3,0	2,9	79,3	81,1	T60006-L2160-W982

\* A<sub>L</sub> = inductance for N = 1 (tolerance +45 % / -25 %) \*\* I<sub>cm</sub> : the listed saturation currents are guidelines, only. They are calculated for nominal core dimensions at room temperature and for approx. 70 % saturation flux density. The frequency-dependent saturation behaviour is demonstrated in Fig. 12.

# Core stack assemblies with nanocrystalline cores

Single-turn chokes employing a number of nanocrystalline cores assembled in a stack are an effective solution for bearing current problems or extremely high common mode noise from other causes in large-scale variable speed drives, wind generators and other applications in which resonance phenomena cause high-amplitude interference currents (with peak values ranging from several 10 A to over 100 A). These generally take the form of short and thus high-frequency current peaks. For these applications, VAC offers assembled core stacks which can be easily and securely integrated into existing applications with the minimum of effort.

The core stacks are available in two sizes with two different through-hole diameters. They are custom-designed, allowing an individual selection of core type and the number of stacked cores (up to 7 pieces) depending on the required saturation level and the required inductance.

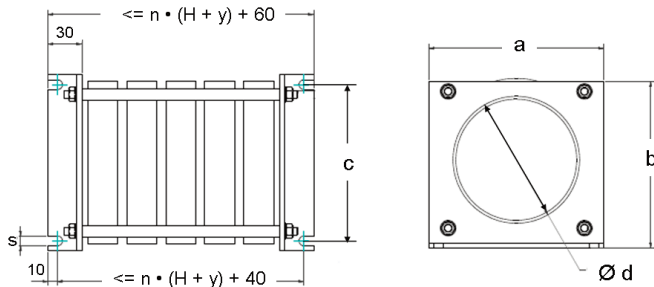
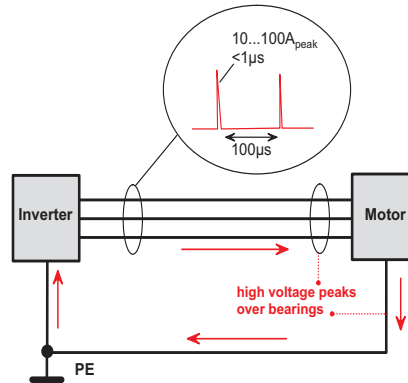
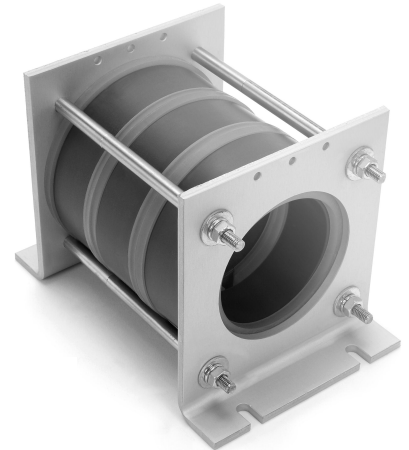

Dimensions of the core stack assemblies

	Size 1	Size 2
a (mm)	120	180
b (mm)	130	190
c (mm)	70	130
d (mm)	~ 70	> 118
s (mm)	7	10

n = number of stacked cores

H = maximum core height

y = 9.5 for epoxy coated cores, T60004...

y = 10.2 for cased cores, T60006...

The inductance L of a core stack can be calculated by multiplying the number of stacked cores with the AL-value of the single core.

$A_L$  : inductance of single core

$I_{cm}$  : maximum permissible leakage or common mode current.

Calculated guideline for nominal core dimensions at room temperature and for approximately 70 % saturation flux density.

core data						data of core stack example for 5 stacked cores					
core part number	nominal core dimensions $d_x \times d_l \times h$ mm x mm x mm	limit core dimensions (incl. Case/coating)			$A_L$ (10 kHz)	$A_L$ (100 kHz)	$I_{cm}$ (10 kHz)	$I_{cm}$ (100 kHz)	L (10 kHz)	L (100 kHz)	
		OD	ID	H	nominal	nominal					size
		mm	mm	mm	$\mu H$	$\mu H$	A	A	$\mu H$	$\mu H$	
T60004-L2100-W629	100 x 80 x 20	104,0	75,0	23,0	17,3	11,2	1	7,1	10,7	86,5	56,0
T60004-L2100-W723	100 x 80 x 20	104,0	75,0	23,0	11,2	10,0	1	10,9	13,8	56,0	50,0
T60006-L2100-V082	100 x 80 x 25	105,5	75,0	29,6	56,3	16,9	1	2,8	5,3	281,5	84,5
T60006-L2100-V081	100 x 80 x 25	105,5	75,0	29,6	14,5	13,1	1	10,9	13,8	72,5	65,5
T60006-L2102-W468	102 x 76 x 25	108,1	70,0	30,3	68,8	21,6	1	3,8	6,7	344,0	108,0
T60006-L2102-V080	102 x 76 x 25	108,1	70,0	30,3	19,1	17,2	1	10,7	13,6	95,5	86,0
T60006-L2102-W947	102 x 76 x 25	108,1	70,0	30,3	4,3	4,2	1	47,4	48,5	21,5	21,0
T60006-L2160-V074	160 x 130 x 25	166,9	123,9	30,5	26,8	13,7	2	8,4	13,6	134,0	68,5
T60006-L2160-V088	160 x 130 x 25	166,9	123,9	30,5	20,1	13,1	2	11,3	17,1	100,5	65,5
T60006-L2160-V066	160 x 130 x 25	166,9	123,9	30,5	12,9	11,7	2	17,6	22,3	64,5	58,5
T60006-L2160-W982	160 x 130 x 25	166,9	123,9	30,5	3,0	2,9	2	79,3	81,1	15,0	14,3

# Common mode chokes

## UL1446 STANDARD SERIES

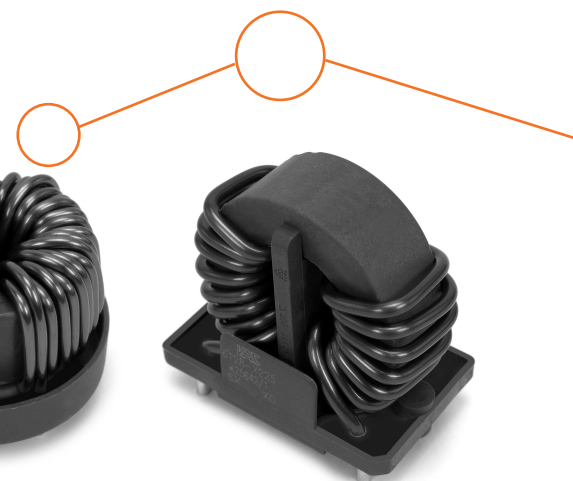

### General information

Chokes are designed, manufactured and tested in compliance with EN50178.

Plastic materials comply with the following UL standards:  
 UL94 (file number E41871)  
 UL1446 (file number OBJY2.E329745)

Temperature class B (130 °C)

$I_N$  = nominal current in each winding  
 $U_{N\ OVCat\ III / II}$  = operating voltage for overvoltage category III / II  
 $L_N$  = nominal inductance, tolerance +50% / -30 %  
 Ambient temperature  $T_a = -40^\circ\text{C} \dots +70^\circ\text{C}$  (short-term  $+90^\circ\text{C}$ )  
 Operating temperature  $T_{op} = -40^\circ\text{C} \dots +130^\circ\text{C}$  (short-term  $+150^\circ\text{C}$ )

The standard chokes are designed for a temperature rise of  $\Delta T = 45 \dots 60\text{ K}$  at  $T_a = 70^\circ\text{C}$  and  $I = I_N$  in each winding. Data derating is necessary for deviating ambient temperature or deviating nominal current. Please contact VAC for further detailed information.

### Standard series CMCs for single-phase applications

$I_N$ A	design	$U_N$ OVCat III / II V	$L_N$		$R_{Cu}$ typ. mΩ	$ Z $ 100kHz Ω	$f_R$ typ. MHz	$I_{cm}$ 10 kHz mA	dimensions			part number
			10 kHz mH	100 kHz mH					l mm	b mm	h mm	
2	upright	300 / 600	2x12.1	2x2.8	101	3000	3,6	17	22	12	25	T60405-R6131-X402
4	upright	300 / 600	2x10.8	2x2.5	27,5	2320	1.2	12	22	12	25	T60405-R6131-X204
4.5	upright	300 / 600	2x28.3	2x6.6	36	6500	0,4	18	27	17	29	T60405-R6161-X504
6	upright	300 / 600	2x29.1	2x6.7	37,6	8500	0,25	14	35	21	37	T60405-R6166-X206
8	upright	300 / 600	2x16.4	2x3.7	19,1	4200	0,5	20	35	21	36,5	T60405-R6166-X208
10	low profile	300 / 600	2x11.4	2x2.6	12,2	3200	0,7	16	35	35	23	T60405-R6123-X210
10	upright	300 / 600	2x11.4	2x2.6	12,7	3150	0.7	16	35	21	37	T60405-R6166-X210
12	upright	300 / 600	2x11.4	2x2.6	8.9	2950	0,7	22	38	22	35	T60405-R6126-X212
12	low profile	300 / 600	2x11.4	2x2.6	8,8	2950	0,7	22	35	35	25	T60405-R6123-X213
13	low profile	300 / 600	2x8.6	2x2.2	6,3	2250	1,1	28	35	35	22	T60405-R6122-X100
16	low profile	300 / 600	2x12.9	2x3.1	5,7	3000	3.0	37	40	40	24	T60405-R6123-X616
16	upright	300 / 600	2x6	2x1.5	4,6	1600	1.0	35	38	21	38	T60405-R6166-X033
16	upright	300 / 600	2x2.9	2x0.7	3,9	830	3,3	60	36	21	38	T60405-R6166-X039
20	low profile	300 / 600	2x1.8	2x0.4	3,2	500	11,5	40	35	35	23,5	T60405-R6123-X220
20	low profile	300 / 600	2x6.6	2x1.6	2.9	1470	5,7	35	43	43	24	T60405-R6123-X221
25	low profile	300 / 600	2x4.2	2x1	1.9	970	7,1	50	42,5	42,5	25	T60405-R6123-X226
25	low profile	600 / 1000	2x12	2x2.8	3,5	2900	2,4	55	52	52	32	T60405-R6123-X227
25	upright	300 / 600	2x4.2	2x1	1.9	970	4,9	50	42	27	40	T60405-R6128-X225
30	low profile	600 / 1000	2x3.9	2x0.9	2.4	920	7.0	50	52	52	29	T60405-R6123-X232
30	upright	600 / 1000	2x3.9	2x0.9	2,3	900	4.0	65	51	27	50	T60405-R6128-X031
40	low profile	600 / 1000	2x3.6	2x0.8	1.4	870	8,2	90	52	52	32	T60405-R6123-X241
48	low profile	600 / 1000	2x2.5	2x0.6	0.75	660	6,7	110	52	52	32	T60405-R6123-X248
63	low profile	600 / 1000	2x1.6	2x0.4	0,5	390	9,3	150	53,5	53,5	32	T60405-R6123-X263
85	low profile	600 / 1000	2x1.6	2x0.5	0.6	510	1,6	200	73	73	40	T60405-R6123-X285

$R_{Cu}$ : winding resistance per winding  $|Z|$ : choke impedance  $f_R$ : choke resonance frequency

For more detailed technical information please see our product data sheets at [www.vacuumschmelze.com](http://www.vacuumschmelze.com). Custom CMCs for other nominal currents, in different designs and with other properties are available on request.

# 3- and 4-phase CMCs

Toleranz der Stiftabstände  
±0,3mm  
(Tolerances grid distance)

DC = Date Code  
F = Factory

VAC

Trennsteg  
(separation)  
≥5.5mm

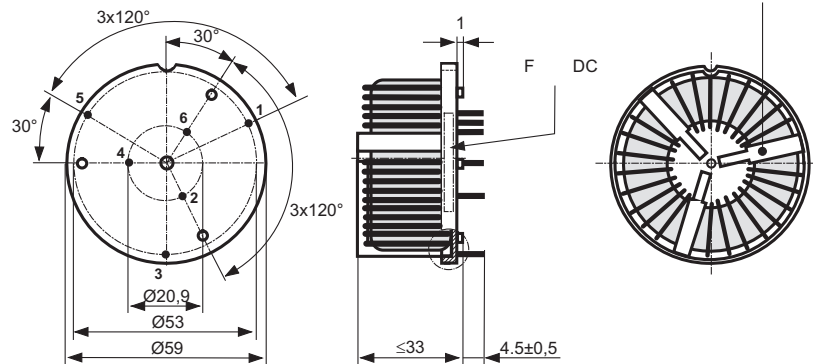

We provide more detailed technical information (data sheets) for all standard products on our web-page [www.vacuumschmelze.com](http://www.vacuumschmelze.com). Example outline of the 3-phase CMC T60405-S6123-X332.

## standard series 3-phase chokes for 3-phase applications

I <sub>N</sub> A	design	U <sub>N</sub> OV/Cat III / II V	L <sub>N</sub>		R <sub>Cu</sub> mΩ	Z  100kHz Ω	f <sub>R</sub> MHz	I <sub>cm</sub> 10 kHz mA	dimensions			part number
			10 kHz mH	100 kHz mH					l mm	b mm	h mm	
7	low profile	600 / 1000	3x31.8	3x7.4	24,6	8650	0,23	27	40,5	40,5	32,5	T60405-S6123-X306
10	low profile	600 / 1000	3x13.9	3x3.2	14	3500	1,5	30	51	51	32	T60405-S6123-X310
11	low profile	600 / 1000	3x10.6	3x2.5	8,5	2600	0,8	40	42	42	32	T60405-S6123-X308
12	low profile	600 / 1000	3x5.7	3x3.7	11,8	2650	0,48	150	51	51	32	T60405-S6123-X312
16	low profile	600 / 1000	3x4.8	3x3.1	6,5	2500	0,65	200	59	59	32	T60405-S6123-X316
16	low profile	600 / 1000	3x9.4	3x2.2	5,9	2400	1,45	35	51,5	51,5	34	T60405-S6123-X317
20	low profile	600 / 1000	3x10.6	3x2.4	4,1	2650	0,9	60	59	59	33	T60405-S6123-X320
25	low profile	600 / 1000	3x2	3x1.3	2,27	1000	2,8	380	60	60	33	T60405-S6123-X325
25	low profile	600 / 1000	3x4.9	3x1.1	2,1	1150	2	60	51,5	51,5	32	T60405-S6123-X326
32	low profile	600 / 1000	3x1.2	3x0.8	1,4	600	4,9	480	59	59	33	T60405-S6123-X332
40*	low profile	600 / 1000	3x2.5	3x0.6	1,2	600	4,7	100	52	52	33	T60405-S6123-X140
40*	low profile	600 / 1000	3x1.5	3x0.8	1,72	680	4	380	70	70	37	T60405-S6123-X240
63	low profile	600 / 1000	3x1.6	3x0.5	0,72	500	1	190	70	70	42	T60405-S6123-X363
70	low profile	600 / 1000	3x0.8	3x0.5	0,86	415	1,45	900	85	85	53	T60405-S6123-X370
110	low profile	600 / 1000	3x0.7	3x0.6	0,63	430	1,4	1750	135	135	57	T60405-S6123-X311

## standard series 4-fold chokes

10**	low profile	600 / 1000	4x6.9	4x1.6	7,66	1500	1,7	40	51	51	33	T60405-S6123-X400
12												
16**	low profile	600 / 1000	4x3.6	4x0.8	2,75	860	3,4	90	51,5	51,5	33	T60405-S6123-X401
20												
24**	low profile	600 / 1000	4x3.2	4x0.7	1,5	750	3,5	100	60	60	33,5	T60405-S6123-X402
30												
32**	low profile	600 / 1000	4x1.4	4x0.3	0,82	360	7	160	60	60	33	T60405-S6123-X403
40												

\* for T<sub>a</sub> ≤ 60°C

\*\* for T<sub>a</sub> ≤ 85°C

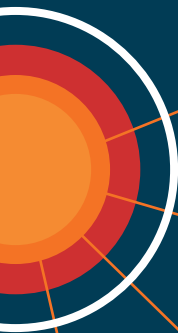

**VACUUMSCHMELZE GMBH & CO. KG**

GRÜNER WEG 37  
D 63450 HANAU / GERMANY  
PHONE +49 6181 38 0  
FAX +49 6181 38 2645  
INFO@VACUUMSCHMELZE.COM  
WWW.VACUUMSCHMELZE.COM

**VAC SALES USA LLC**

2935 DOLPHIN DRIVE / SUITE 102  
42701 ELIZABETHTOWN KY / USA  
PHONE +1 270 769-1333  
FAX +1 270 765 3118  
INFO-USA@VACUUMSCHMELZE.COM

**VACUUMSCHMELZE SALES OFFICE SINGAPUR**

61 KAKI BUKIT AVENUE 1  
#04-16 SHUN LI INDUSTRIAL PARK  
SINGAPORE 417943  
PHONE (+65) 63 91 26 00  
Fax: (+65) 63 91 26 01  
VACSINGAPORE@VACUUMSCHMELZE.COM

**PKB-EMC Edition 2010**

All rights reserved.

VITROPERM® is a registered trademark of VACUUMSCHMELZE GmbH & Co. KG in Germany, Austria and Switzerland. As far as patents or other rights of third parties are concerned, liability is only assumed for product per se, not for applications, processes and circuits implemented within these products. The information describes the type of product and shall not be considered as assured characteristics. Terms of delivery and right to change design reserved.



**ADVANCED MATERIALS – THE KEY TO PROGRESS**