

## AN-1713 LM5116-12 Evaluation Board

### 1 Introduction

The LM5116-12 evaluation board is designed to provide the design engineer with a fully functional power converter based on Emulated Current Mode Control to evaluate the LM5116 controller IC. The evaluation board provides a 12V output with a 5A current capability. The operating input voltage ranges from 15V to 80V. The design operates at 250kHz, a good compromise between conversion efficiency and solution size. The printed circuit board consists of 4 layers, 2 ounce copper top and bottom, 1 ounce copper internal layers on FR4 material with a thickness of 0.06 inches. This user's guide contains the evaluation board schematic, Bill-of-Materials (BOM), and a quick setup procedure. For complete circuit design information, see *LM5116 Wide Range Synchronous Buck Controller* ([SNVS499](#)).

The performance of the evaluation board is:

- Input Range: 15V to 80V
- Output Voltage: 12V
- Output Current: 0 to 5A
- Frequency of Operation: 250 kHz
- Board Size: 2.55 × 2.65 × 0.7 inches
- Load Regulation: 1%
- Line Regulation: 0.1%
- Hiccup Mode Current Limit Protection

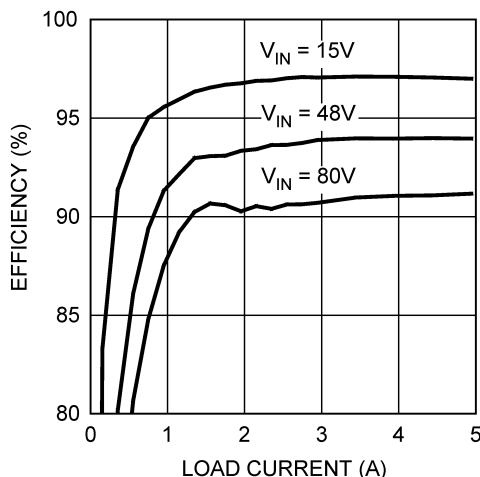

**Figure 1. Efficiency with 10 µH Gowanda Inductor**

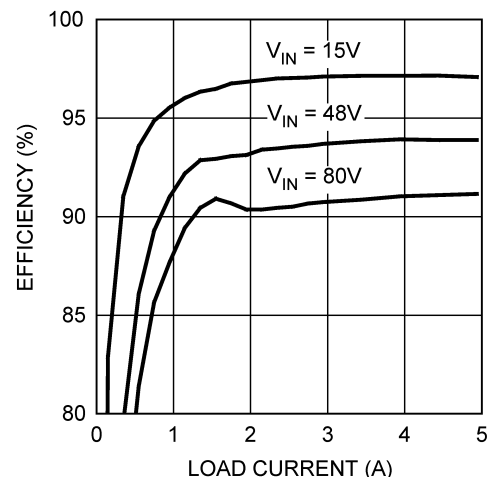

**Figure 2. Efficiency with 10 µH Pulse Inductor**

## 2 Powering and Loading Considerations

Read this entire section prior to attempting to power the evaluation board.

### 2.1 Quick Setup Procedure

**Step 1:** Set the power supply current limit to 10A. Turn off the power supply. Connect the power supply to the  $V_{IN}$  terminals.

**Step 2:** Connect the load, with a 5A capability, to the  $V_{OUT}$  terminals. The positive connection goes to P3 and negative connection to P4.

**Step 3:** The EN pin should be left open for normal operation.

**Step 4:** Set  $V_{IN}$  to 48V with no load applied.  $V_{OUT}$  should be in regulation with a nominal 12V output.

**Step 5:** Slowly increase the load while monitoring the output voltage,  $V_{OUT}$  should remain in regulation with a nominal 12V output as the load is increased up to 5 Amps.

**Step 6:** Slowly sweep the input voltage from 15V to 80V,  $V_{OUT}$  should remain in regulation with a nominal 12V output.

**Step 7:** Temporarily short the EN pin to GND to check the shutdown function.

**Step 8:** Increase the load beyond the normal range to check current limiting. Hiccup mode current limit is used for protection. The peak short circuit current is limited to approximately 11A. Cooling is critical during this step.

### 2.2 Air Flow

Prolonged operation with high input voltage at full power will cause the MOSFETs to overheat. A stand-alone fan with at least 200 LFM should always be provided.

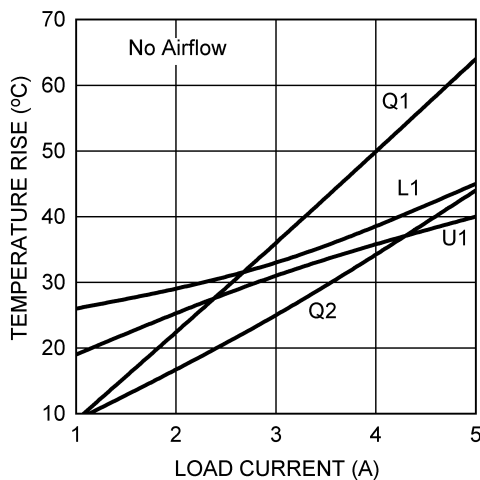

**Figure 3. Temperature Rise at 48V<sub>IN</sub> with 10 µH Gowanda Inductor**

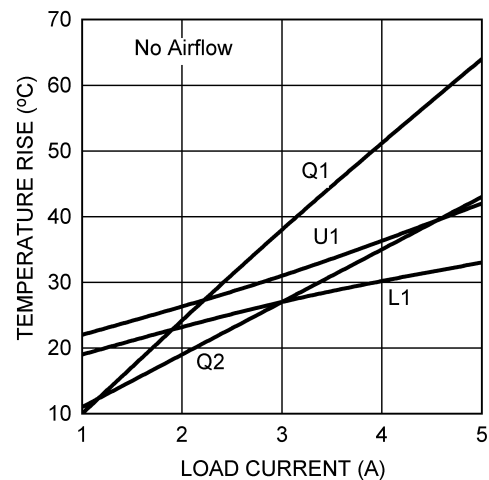

**Figure 4. Temperature Rise at 48V<sub>IN</sub> with 10 µH Pulse Inductor**

### 2.3 Powering Up

Using the enable pin provided will allow powering up the source supply with the current level set low. It is suggested that the load be kept low during the first power up. Set the current limit of the source supply to provide about 1.5 times the anticipated wattage of the load. As you remove the connection from the enable pin to ground, immediately check for 12 volts at the output.

A quick efficiency check is the best way to confirm that everything is operating properly. If something is amiss you can be reasonably sure that it will affect the efficiency adversely. Few parameters can be incorrect in a switching power supply without creating losses and potentially damaging heat.

### 2.4 Over Current Protection

The evaluation board is configured with hiccup mode over-current protection. This helps to limit the thermal stress while in an overloaded condition. If a sustained overload is expected before the onset of hiccup mode, ensure that sufficient cooling (airflow) is maintained. The peak short circuit current is limited to approximately 11A.

For sustained short circuit protection, a counter trips the internal fault timer when a current limit condition exists for more than 256 clock cycles. C7 sets the off-time of the current limit fault timer, which may be lengthened by increasing the value of C7. D2 is used to discharge C7 in the event of a fast decay of the input voltage. Though not recommended, the hiccup fault timer may be disabled by removing C7.

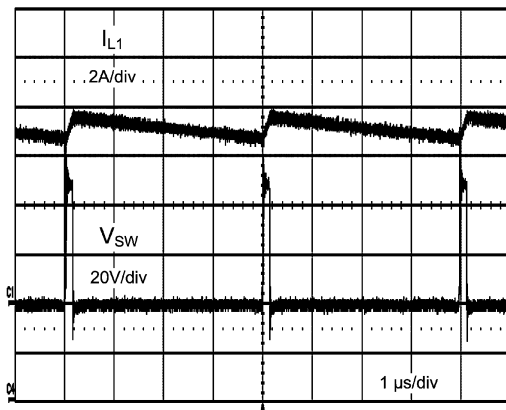

Figure 5. Short Circuit at 48V<sub>IN</sub>

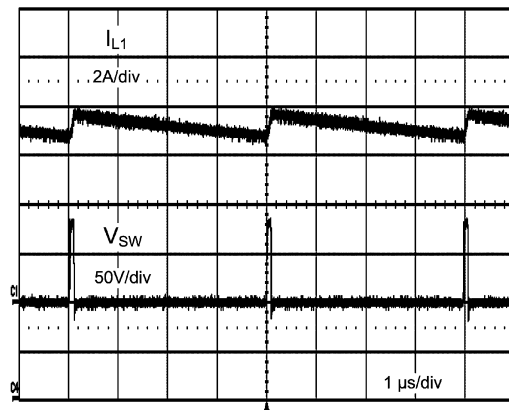

Figure 6. Short Circuit at 80V<sub>IN</sub>

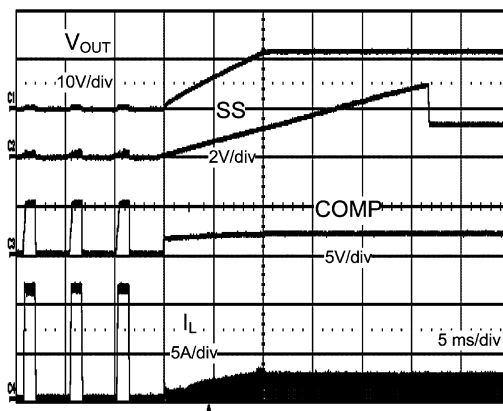

Figure 7. Short Circuit Recovery into Resistive Load

## 2.5 Synchronization

A SYNC pin has been provided on the evaluation board. This pin can be used to synchronize the regulator to an external clock. For complete information, see *LM5116 Wide Range Synchronous Buck Controller (SNVS499)*.

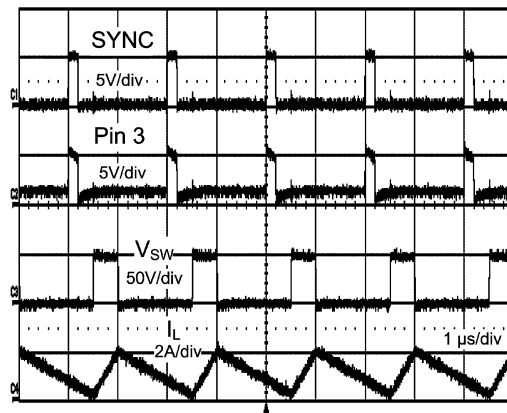

Figure 8. Synchronization at  $48V_{IN}$

## 2.6 Active Loads

Figure 9 shows a typical start-up characteristic into a constant current active load. This type of load can exhibit an initial short circuit, which is sustained well beyond the duration of the fault timer. Increasing the soft-start time improves the ability to start into this type of load. For the extreme case, the hiccup fault timer may be disabled by removing C7. A sustained short circuit should be avoided when the fault timer is not used.

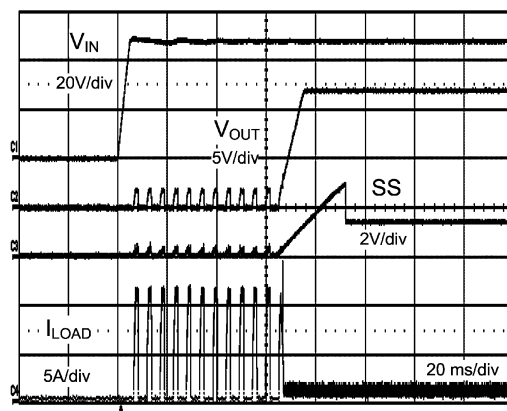

Figure 9. Start-up into Active Load at  $48V_{IN}$

### 3 Typical Performance Waveforms

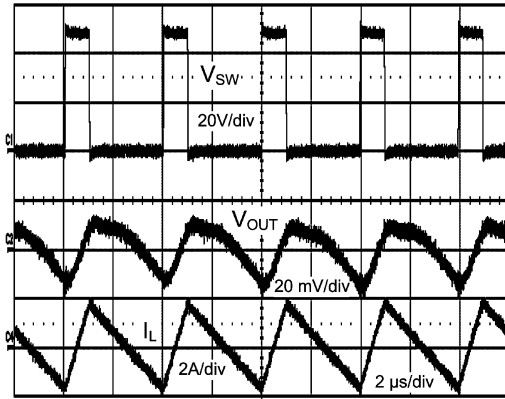

Figure 10. Synchronous Operation at 48V<sub>IN</sub> with JMP1 Removed

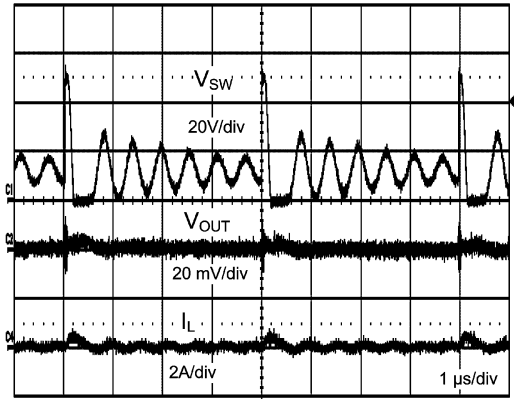

Figure 11. Discontinuous Operation using Diode Emulation Mode at 48V<sub>IN</sub> with JMP1 Installed

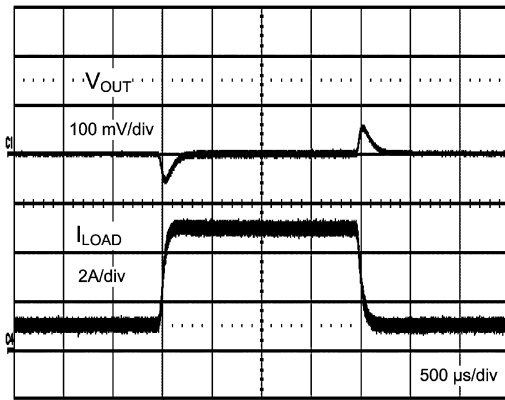

Figure 12. Transient Response at 48V<sub>IN</sub>

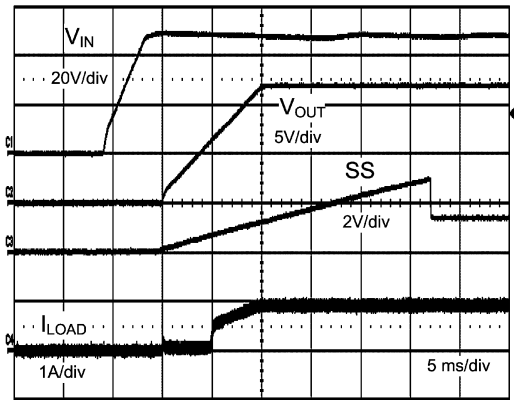

Figure 13. Start-up into Resistive Load at 48V<sub>IN</sub>

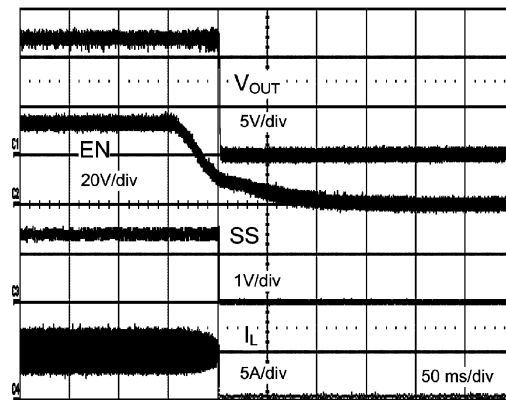
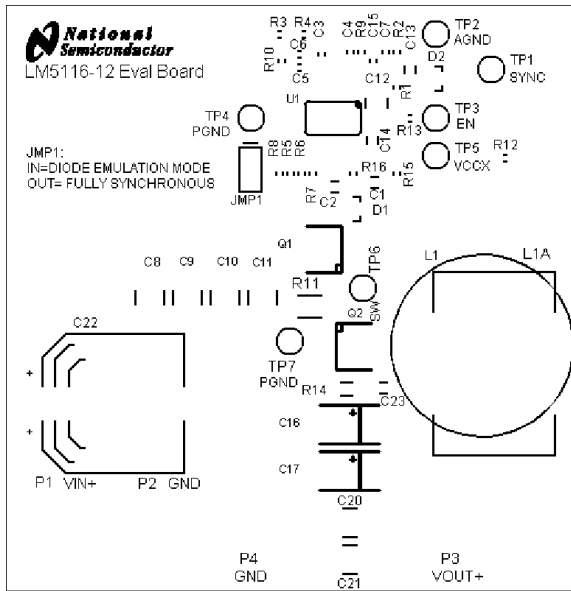

Figure 14. Shut Down at 48V<sub>IN</sub>

**4 Bill of Materials**

ID	Part Number	Type	Size	Parameters	Qty	Vendor
C1, C2, C14	C2012X7R1E105K	Capacitor, Ceramic	0805	1 $\mu$ F, 25V, X7R, 10%	3	TDK
C3	C1608X7R1H104K	Capacitor, Ceramic	0603	0.1 $\mu$ F, 50V, X7R, 10%	1	TDK
C4	VJ0603A331JXAA	Capacitor, Ceramic	0603	330 pF, 50V, COG, 5%	1	Vishay
C5	VJ0603A150KXAA	Capacitor, Ceramic	0603	15 pF, 50V, COG, 10%	1	Vishay
C6	VJ0603Y152KXXA	Capacitor, Ceramic	0603	1500 pF, 25V, X7R, 10%	1	Vishay
C7	C1608X7R1C105K	Capacitor, Ceramic	0603	1 $\mu$ F, 16V, X7R, 10%	1	TDK
C8, C9, C10, C11	C4532X7R2A225M	Capacitor, Ceramic	1812	2.2 $\mu$ F, 100V X7R, 20%	4	TDK
C12	C3225X7R2A105M	Capacitor, Ceramic	1210	1 $\mu$ F, 100V X7R, 20%	1	TDK
C13	C2012X7R2A104K	Capacitor, Ceramic	0805	0.1 $\mu$ F, 100V X7R, 10%	1	TDK
C15	VJ0603A101KXAA	Capacitor, Ceramic	0603	100 pF, 50V, COG, 10%	1	Vishay
C16, C17, C18, C19	T520D476M016ATE035	Capacitor, Polymer	D Case	47 $\mu$ F, 16V, 35m $\Omega$	4	KEMET
C20	C4532X7R1C226M	Capacitor, Ceramic	1812	22 $\mu$ F, 16V, X7R, 20%	1	TDK
C21		Capacitor, Ceramic	1812	Not Used	0	
C22	EEV-FK2A470Q	Capacitor, Electrolytic	SMD	47 $\mu$ F, 100V, Case Size: 12.5mm X 13.5mm	1	Panasonic
C23		Capacitor, Ceramic	0805	Not Used	0	
D1, D2	CMPD2003	Diode, Switching	SOT-23	200 mA, 200V	2	Central Semi
JMP1		Connector, Jumper		2 pin sq. post	1	
L1	121KM1002H	Inductor		10 $\mu$ H, 8.72A, 10 m $\Omega$	1	Gowanda
L1A	PA2050.103NL	Inductor		10 $\mu$ H, 14.7A, 5.8 m $\Omega$	0	Pulse
P1-P4	1514-2	Turret Terminal	.090" dia.		4	Keystone
TP1-TP7	5012	Test Point	.040" dia.		7	Keystone
Q1, Q2	Si7852DP	N-CH MOSFET	SO-8 Power PAK	12.5A, 80V, 22 m $\Omega$	2	Vishay Siliconix
R1	CRCW06031023F	Resistor	0603	102 k $\Omega$ , 1%	1	Vishay
R2	CRCW06039311F	Resistor	0603	9.31 k $\Omega$ , 1%	1	Vishay
R3	CRCW06031072F	Resistor	0603	10.7 k $\Omega$ , 1%	1	Vishay
R4	CRCW06031211F	Resistor	0603	1.21 k $\Omega$ , 1%	1	Vishay
R5		Resistor	0603	Not Used	0	
R6, R7	CRCW06030R0J	Resistor	0603	0 $\Omega$	2	Vishay
R8	CRCW0603103J	Resistor	0603	10 k $\Omega$ , 5%	1	Vishay
R9	CRCW06031242F	Resistor	0603	12.4 k $\Omega$ , 1%	1	Vishay
R10	CRCW0603393J	Resistor	0603	39 k $\Omega$ , 5%	1	Vishay
R11	LRC-LRF2010-01-R010-F	Resistor	2010	0.010 $\Omega$ , 1%	0	IRC
R11	WSL2010R0100FEA	Resistor	2010	0.010 $\Omega$ , 1%	1	Vishay
R12	CRCW06031R0J	Resistor	0603	1 $\Omega$ , 5%	1	Vishay
R13	CRCW0603105J	Resistor	0603	1 M $\Omega$ , 5%	1	Vishay
R14		Resistor	1206	Not Used	0	
R15	CRCW06037503F	Resistor	0603	750 k $\Omega$ , 1%	1	Vishay
R16	CRCW06032R2J	Resistor	0603	2.2 $\Omega$ , 5%	1	Vishay
U1	LM5116	Synchronous Buck Controller	HTSSOP-20		1	Texas Instruments

## 5 PCB Layout



TOP SILKSCREEN (PLC) AS VIEWED FROM TOP  
880013185-002

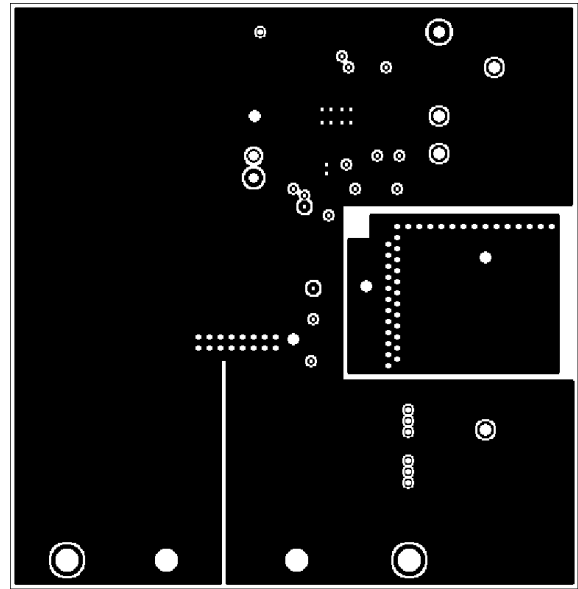

LAYER 2 (LY2) AS VIEWED FROM TOP  
880013185-002

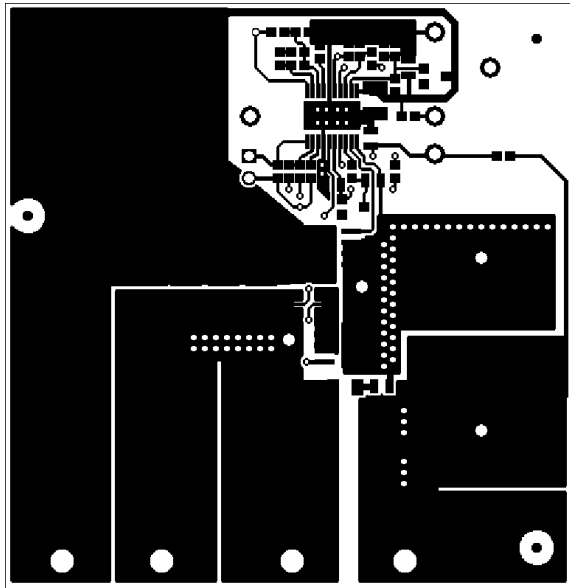

TOP (CMP) LAYER AS VIEWED FROM TOP  
880013185-002

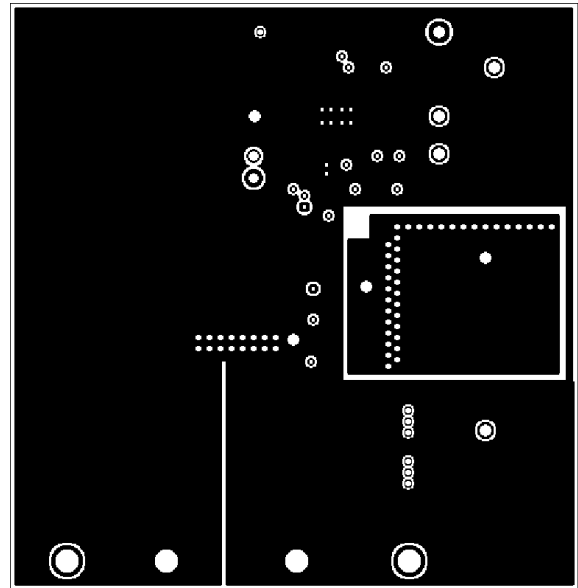

LAYER 3 (LY3) AS VIEWED FROM TOP  
880013185-002

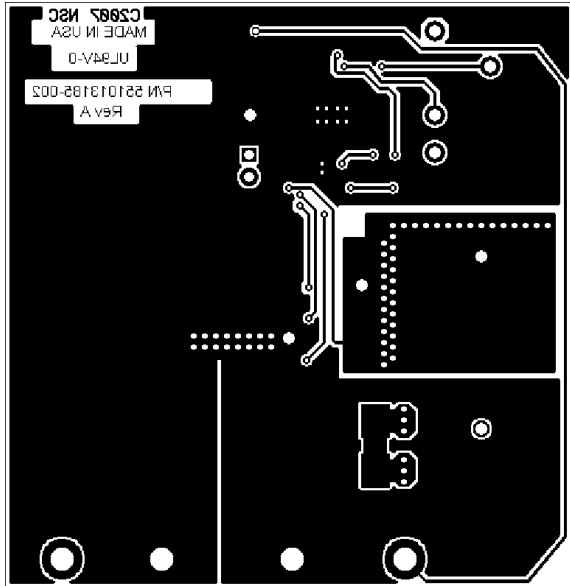

BOTTOM (.SOL) LAYER AS VIEWED FROM TOP  
880013185-002

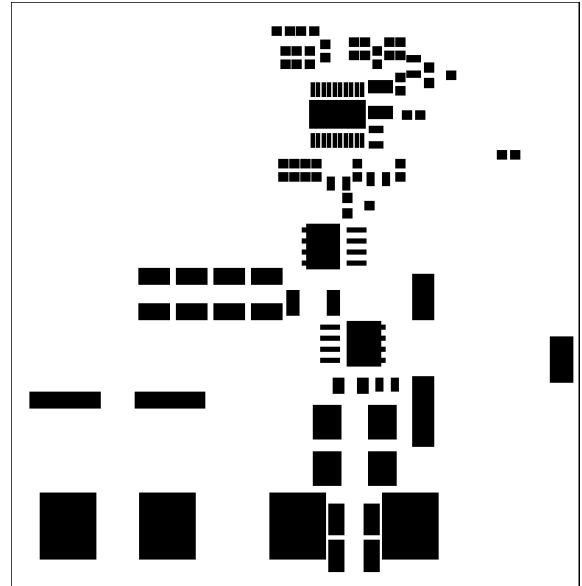

TOP SOLDER PASTE MASK (.CRC) AS VIEWED FROM TOP  
881013185-002

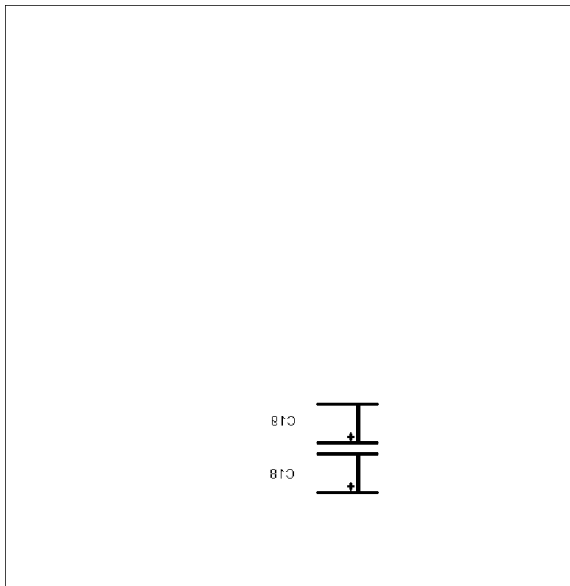

BOTTOM SILK SCREEN (.PLS) LAYER AS VIEWED FROM TOP  
880013185-002

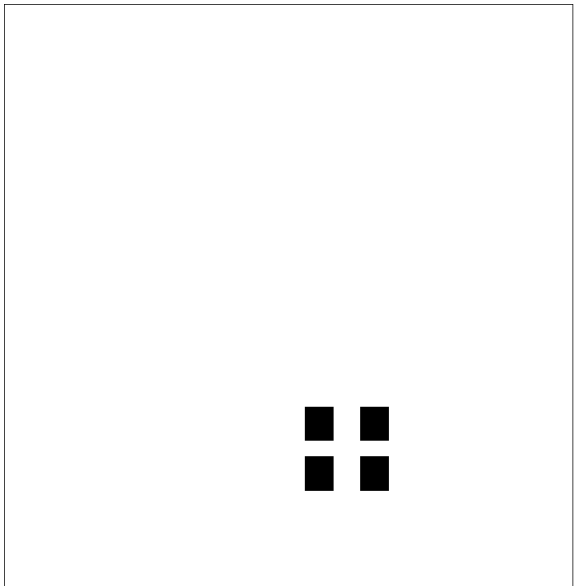

BOTTOM SOLDER PASTE MASK (.CRS) LAYER AS VIEWED FROM TOP  
881013185-002



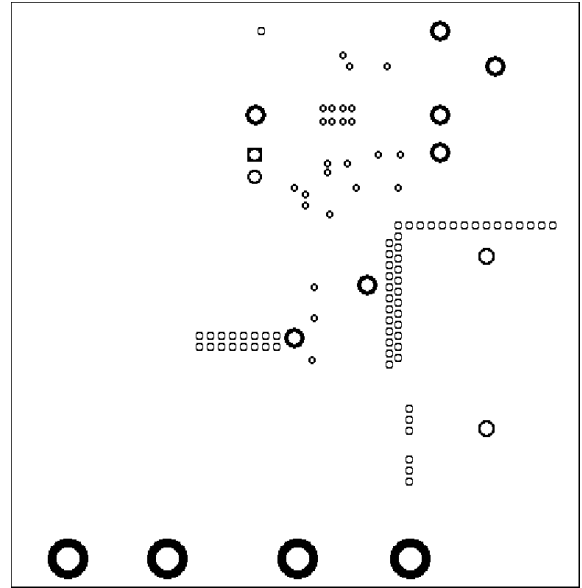
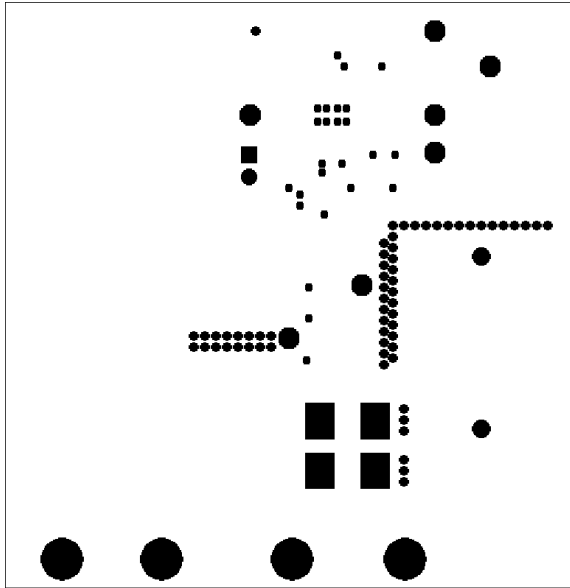

BOTTOM SOLDER MASK (.STS) LAYER AS VIEWED FROM TOP  
880013185-002

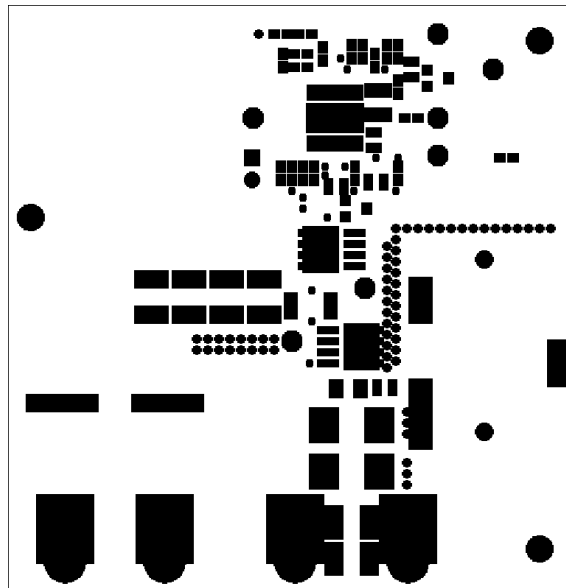

TOP SOLDERMASK (.STC) LAYER AS VIEWED FROM TOP  
880013185-002

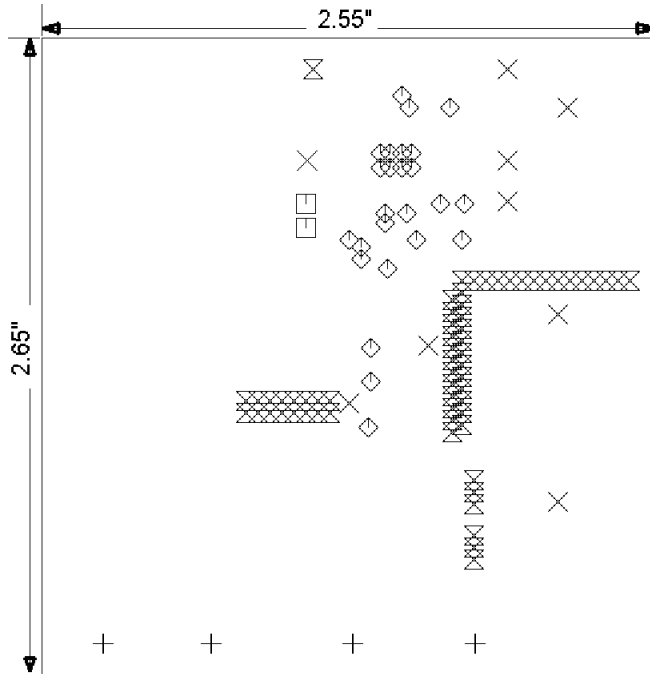

DRILL GUIDE	
+	0.014, +0.002, -0.002 INCHES
△	0.018, +0.002, -0.002 INCHES
◊	0.038, +0.003, -0.003 INCHES
×	0.047, +0.003, -0.002 INCHES
▽	0.100, +0.005, -0.002 INCHES

DRILLS AND DIMENSIONS (.FAB) LAYER AS VIEWED FROM TOP  
880013185-002

## 6 Evaluation Board Schematic

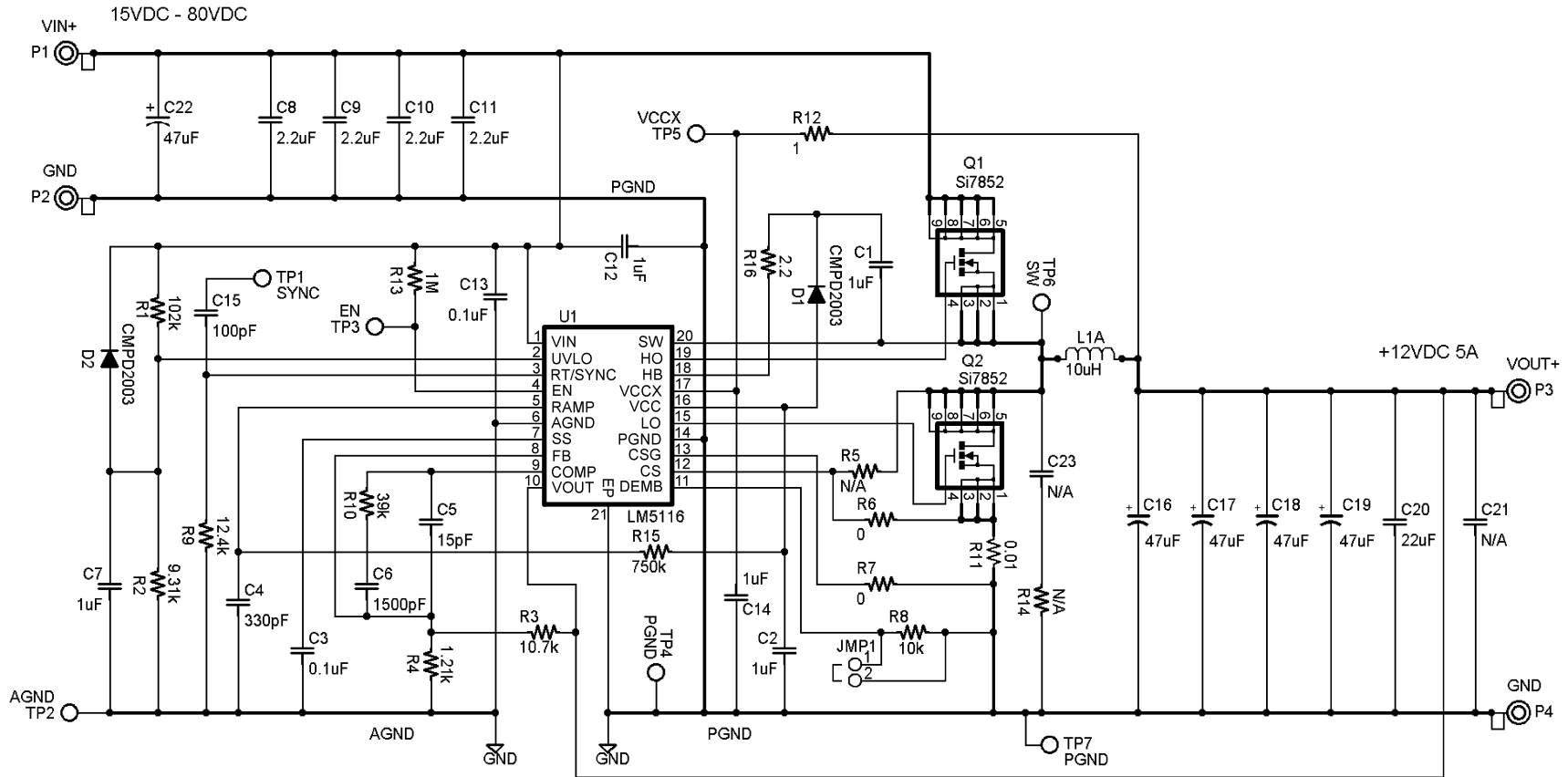

Figure 15. Evaluation Board Schematic

## IMPORTANT NOTICE

Texas Instruments Incorporated and its subsidiaries (TI) reserve the right to make corrections, enhancements, improvements and other changes to its semiconductor products and services per JESD46, latest issue, and to discontinue any product or service per JESD48, latest issue. Buyers should obtain the latest relevant information before placing orders and should verify that such information is current and complete. All semiconductor products (also referred to herein as "components") are sold subject to TI's terms and conditions of sale supplied at the time of order acknowledgment.

TI warrants performance of its components to the specifications applicable at the time of sale, in accordance with the warranty in TI's terms and conditions of sale of semiconductor products. Testing and other quality control techniques are used to the extent TI deems necessary to support this warranty. Except where mandated by applicable law, testing of all parameters of each component is not necessarily performed.

TI assumes no liability for applications assistance or the design of Buyers' products. Buyers are responsible for their products and applications using TI components. To minimize the risks associated with Buyers' products and applications, Buyers should provide adequate design and operating safeguards.

TI does not warrant or represent that any license, either express or implied, is granted under any patent right, copyright, mask work right, or other intellectual property right relating to any combination, machine, or process in which TI components or services are used. Information published by TI regarding third-party products or services does not constitute a license to use such products or services or a warranty or endorsement thereof. Use of such information may require a license from a third party under the patents or other intellectual property of the third party, or a license from TI under the patents or other intellectual property of TI.

Reproduction of significant portions of TI information in TI data books or data sheets is permissible only if reproduction is without alteration and is accompanied by all associated warranties, conditions, limitations, and notices. TI is not responsible or liable for such altered documentation. Information of third parties may be subject to additional restrictions.

Resale of TI components or services with statements different from or beyond the parameters stated by TI for that component or service voids all express and any implied warranties for the associated TI component or service and is an unfair and deceptive business practice. TI is not responsible or liable for any such statements.

Buyer acknowledges and agrees that it is solely responsible for compliance with all legal, regulatory and safety-related requirements concerning its products, and any use of TI components in its applications, notwithstanding any applications-related information or support that may be provided by TI. Buyer represents and agrees that it has all the necessary expertise to create and implement safeguards which anticipate dangerous consequences of failures, monitor failures and their consequences, lessen the likelihood of failures that might cause harm and take appropriate remedial actions. Buyer will fully indemnify TI and its representatives against any damages arising out of the use of any TI components in safety-critical applications.

In some cases, TI components may be promoted specifically to facilitate safety-related applications. With such components, TI's goal is to help enable customers to design and create their own end-product solutions that meet applicable functional safety standards and requirements. Nonetheless, such components are subject to these terms.

No TI components are authorized for use in FDA Class III (or similar life-critical medical equipment) unless authorized officers of the parties have executed a special agreement specifically governing such use.

Only those TI components which TI has specifically designated as military grade or "enhanced plastic" are designed and intended for use in military/aerospace applications or environments. Buyer acknowledges and agrees that any military or aerospace use of TI components which have **not** been so designated is solely at the Buyer's risk, and that Buyer is solely responsible for compliance with all legal and regulatory requirements in connection with such use.

TI has specifically designated certain components as meeting ISO/TS16949 requirements, mainly for automotive use. In any case of use of non-designated products, TI will not be responsible for any failure to meet ISO/TS16949.

### Products

Audio	<a href="http://www.ti.com/audio">www.ti.com/audio</a>
Amplifiers	<a href="http://amplifier.ti.com">amplifier.ti.com</a>
Data Converters	<a href="http://dataconverter.ti.com">dataconverter.ti.com</a>
DLP® Products	<a href="http://www.dlp.com">www.dlp.com</a>
DSP	<a href="http://dsp.ti.com">dsp.ti.com</a>
Clocks and Timers	<a href="http://www.ti.com/clocks">www.ti.com/clocks</a>
Interface	<a href="http://interface.ti.com">interface.ti.com</a>
Logic	<a href="http://logic.ti.com">logic.ti.com</a>
Power Mgmt	<a href="http://power.ti.com">power.ti.com</a>
Microcontrollers	<a href="http://microcontroller.ti.com">microcontroller.ti.com</a>
RFID	<a href="http://www.ti-rfid.com">www.ti-rfid.com</a>
OMAP Applications Processors	<a href="http://www.ti.com/omap">www.ti.com/omap</a>
Wireless Connectivity	<a href="http://www.ti.com/wirelessconnectivity">www.ti.com/wirelessconnectivity</a>

### Applications

Automotive and Transportation	<a href="http://www.ti.com/automotive">www.ti.com/automotive</a>
Communications and Telecom	<a href="http://www.ti.com/communications">www.ti.com/communications</a>
Computers and Peripherals	<a href="http://www.ti.com/computers">www.ti.com/computers</a>
Consumer Electronics	<a href="http://www.ti.com/consumer-apps">www.ti.com/consumer-apps</a>
Energy and Lighting	<a href="http://www.ti.com/energy">www.ti.com/energy</a>
Industrial	<a href="http://www.ti.com/industrial">www.ti.com/industrial</a>
Medical	<a href="http://www.ti.com/medical">www.ti.com/medical</a>
Security	<a href="http://www.ti.com/security">www.ti.com/security</a>
Space, Avionics and Defense	<a href="http://www.ti.com/space-avionics-defense">www.ti.com/space-avionics-defense</a>
Video and Imaging	<a href="http://www.ti.com/video">www.ti.com/video</a>

### TI E2E Community

[e2e.ti.com](http://e2e.ti.com)