

### Dual IGBTMOD™ NFH-Series Module 300 Amperes/1200 Volts

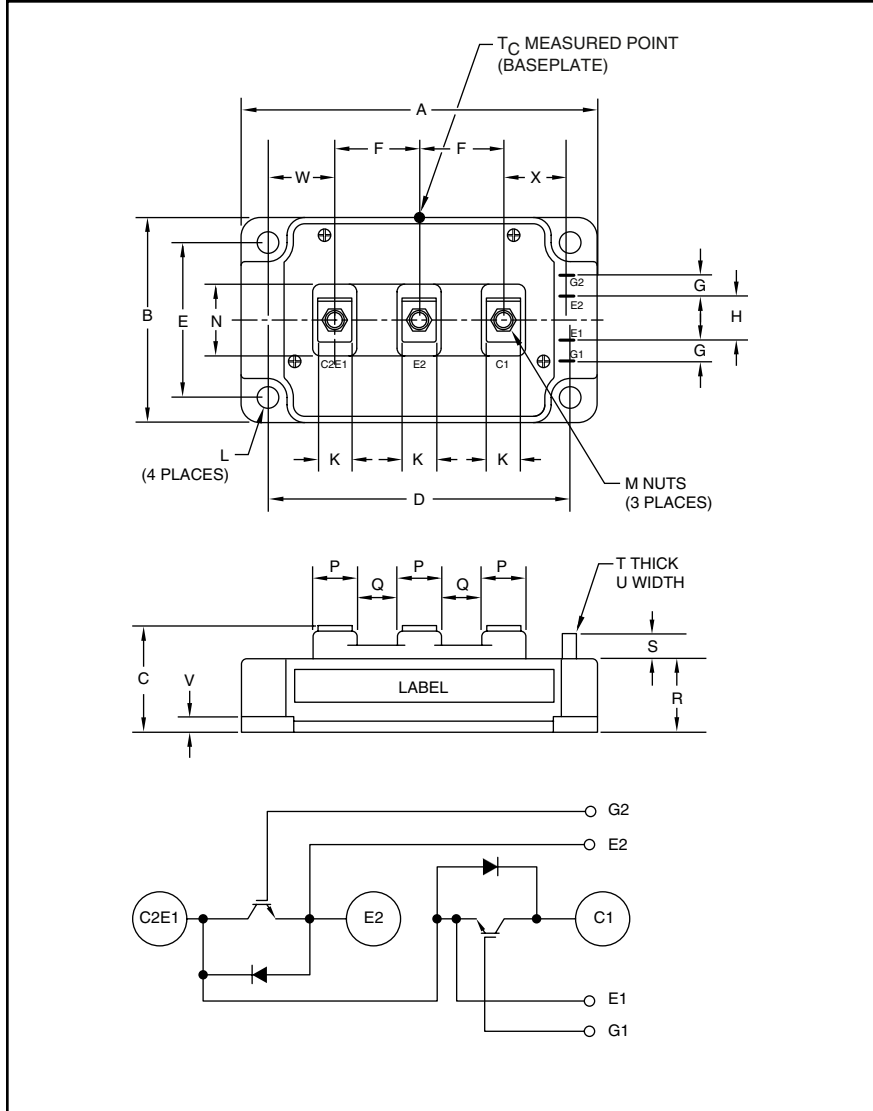

Outline Drawing and Circuit Diagram

Dimensions	Inches	Millimeters
A	4.25	108.0
B	2.44	62.0
C	1.18+0.04/-0.02	30.0+1.0/-0.5
D	3.66±0.01	93.0±0.25
E	1.89±0.01	48.0±0.25
F	0.98	25.0
G	0.24	6.0
H	0.59	15.0
K	0.55	14.0
L	0.26 Dia.	Dia. 6.5
M	M6 Metric	M6

Dimensions	Inches	Millimeters
N	1.18	30.0
P	0.71	18.0
Q	0.28	7.0
R	0.87	22.2
S	0.33	8.5
T	0.02	0.5
U	0.110	2.8
V	0.16	4.0
W	0.85	21.5
X	0.94	24.0

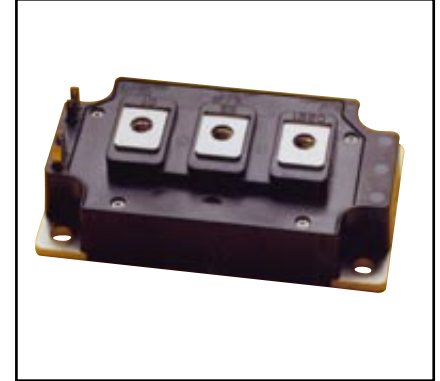

#### Description:

Powerex IGBTMOD™ Modules are designed for use in high frequency applications; 30 kHz for hard switching applications and 60 to 70 kHz for soft switching applications. Each module consists of two IGBT Transistors in a half-bridge configuration with each transistor having a reverse-connected super-fast recovery free-wheel diode. All components and interconnects are isolated from the heat sinking baseplate, offering simplified system assembly and thermal management.

#### Features:

- Low  $E_{SW(off)}$
- Discrete Super-Fast Recovery Free-Wheel Diode
- Isolated Baseplate for Easy Heat Sinking

#### Applications:

- Power Supplies
- Induction Heating
- Welders

#### Ordering Information:

Example: Select the complete part module number you desire from the table below -i.e. CM300DY-24NFH is a 1200V ( $V_{CES}$ ), 300 Ampere Dual IGBTMOD™ Power Module.

Type	Current Rating Amperes	$V_{CES}$ Volts (x 50)
CM	300	24

**CM300DY-24NFH**  
**Dual IGBTMOD™ NFH-Series Module**  
 300 Amperes/1200 Volts

**Absolute Maximum Ratings,  $T_j = 25\text{ }^\circ\text{C}$  unless otherwise specified**

Ratings	Symbol	CM300DY-24NFH	Units
Junction Temperature	$T_j$	-40 to 150	$^\circ\text{C}$
Storage Temperature	$T_{stg}$	-40 to 125	$^\circ\text{C}$
Collector-Emitter Voltage (G-E Short)	$V_{CES}$	1200	Volts
Gate-Emitter Voltage (C-E Short)	$V_{GES}$	$\pm 20$	Volts
Collector Current ( $T_C = 25^\circ\text{C}$ )	$I_C$	300*	Amperes
Peak Collector Current	$I_{CM}$	600*	Amperes
Emitter Current** ( $T_C = 25^\circ\text{C}$ )	$I_E$	300*	Amperes
Peak Emitter Current**	$I_{EM}$	600*	Amperes
Maximum Collector Dissipation ( $T_C = 25^\circ\text{C}, T_j \leq 150^\circ\text{C}$ )	$P_C$	1130	Watts
Maximum Collector Dissipation ( $T_C = 25^\circ\text{C}, T_j \leq 150^\circ\text{C}$ )	$P_C$	1900	Watts
Mounting Torque, M6 Main Terminal	—	40	in-lb
Mounting Torque, M6 Mounting	—	40	in-lb
Weight	—	400	Grams
Isolation Voltage (Main Terminal to Baseplate, AC 1 min.)	$V_{ISO}$	2500	Volts

**Static Electrical Characteristics,  $T_j = 25\text{ }^\circ\text{C}$  unless otherwise specified**

Characteristics	Symbol	Test Conditions	Min.	Typ.	Max.	Units
Collector-Cutoff Current	$I_{CES}$	$V_{CE} = V_{CES}, V_{GE} = 0V$	—	—	1.0	mA
Gate Leakage Current	$I_{GES}$	$V_{GE} = V_{GES}, V_{CE} = 0V$	—	—	1.0	$\mu\text{A}$
Gate-Emitter Threshold Voltage	$V_{GE(th)}$	$I_C = 30\text{mA}, V_{CE} = 10V$	4.5	6.0	7.5	Volts
Collector-Emitter Saturation Voltage	$V_{CE(sat)}$	$I_C = 300\text{A}, V_{GE} = 15V, T_j = 25^\circ\text{C}$	—	5.0	6.5	Volts
		$I_C = 300\text{A}, V_{GE} = 15V, T_j = 125^\circ\text{C}$	—	5.0	—	Volts
Total Gate Charge	$Q_G$	$V_{CC} = 600V, I_C = 300\text{A}, V_{GE} = 15V$	—	1360	—	nC
Emitter-Collector Voltage**	$V_{EC}$	$I_E = 300\text{A}, V_{GE} = 0V$	—	—	3.5	Volts

**Dynamic Electrical Characteristics,  $T_j = 25\text{ }^\circ\text{C}$  unless otherwise specified**

Characteristics	Symbol	Test Conditions	Min.	Typ.	Max.	Units
Input Capacitance	$C_{ies}$		—	—	47	nf
Output Capacitance	$C_{oes}$	$V_{CE} = 10V, V_{GE} = 0V$	—	—	4.0	nf
Reverse Transfer Capacitance	$C_{res}$		—	—	0.9	nf
Inductive	Turn-on Delay Time	$t_{d(on)}$	—	—	300	ns
	Rise Time	$t_r$	—	—	80	ns
Switch	Turn-off Delay Time	$t_{d(off)}$	—	—	500	ns
	Fall Time	$t_f$	—	—	150	ns
Diode Reverse Recovery Time**	$t_{rr}$	$I_E = 300\text{A}$	—	—	250	ns
Diode Reverse Recovery Charge**	$Q_{rr}$		—	13	—	$\mu\text{C}$

\* Pulse width and repetition rate should be such that device junction temperature ( $T_j$ ) does not exceed  $T_{j(max)}$  rating.

\*\*Represents characteristics of the anti-parallel, emitter-to-collector free-wheel diode (FWDi).

**CM300DY-24NFH**  
**Dual IGBTMOD™ NFH-Series Module**  
 300 Amperes/1200 Volts

**Thermal and Mechanical Characteristics,  $T_j = 25\text{ }^\circ\text{C}$  unless otherwise specified**

Characteristics	Symbol	Test Conditions	Min.	Typ.	Max.	Units
Thermal Resistance, Junction to Case	$R_{th(j-c)Q}$	Per IGBT 1/2 Module, $T_C$ Reference Point per Outline Drawing	—	—	0.11	$^\circ\text{C/W}$
Thermal Resistance, Junction to Case	$R_{th(j-c)D}$	Per FWDi 1/2 Module, $T_C$ Reference Point per Outline Drawing	—	—	0.18	$^\circ\text{C/W}$
Thermal Resistance, Junction to Case	$R_{th(j-c)'Q}$	Per IGBT 1/2 Module, $T_C$ Reference Point Under Chips	—	—	0.066	$^\circ\text{C/W}$
Thermal Resistance, Junction to Case	$R_{th(j-c)'D}$	Per FWDi 1/2 Module, $T_C$ Reference Point Under Chips	—	—	0.1	$^\circ\text{C/W}$
Contact Thermal Resistance	$R_{th(c-f)}$	Per 1/2 Module, Thermal Grease Applied	—	0.04	—	$^\circ\text{C/W}$
External Gate Resistance	$R_G$		1.0	—	10	$\Omega$

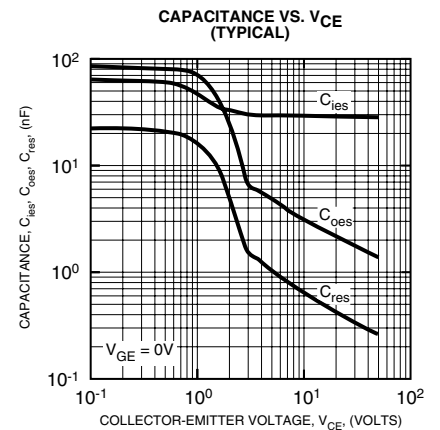
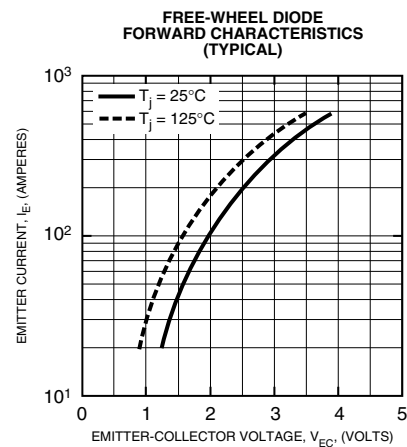
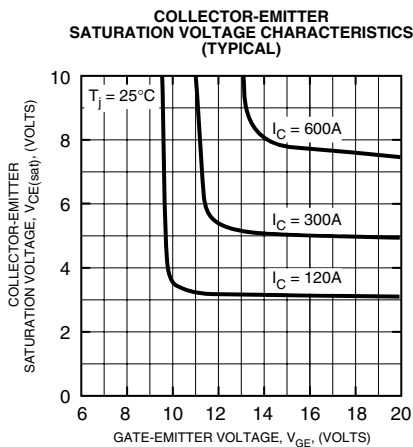
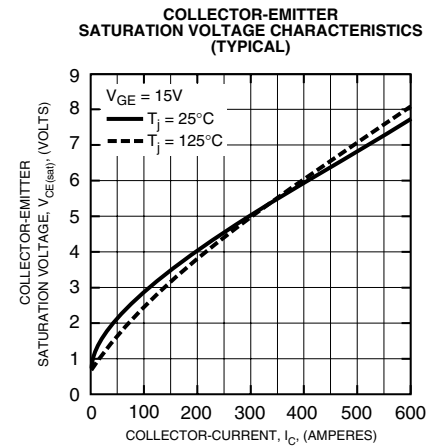
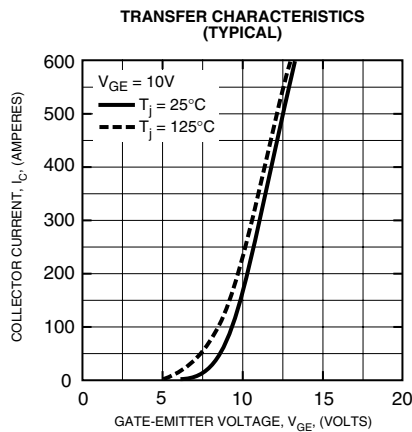
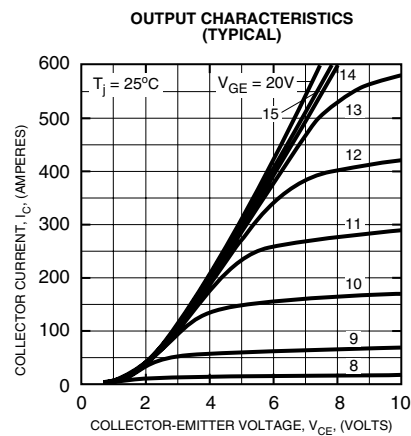

**CM300DY-24NFH**  
**Dual IGBTMOD™ NFH-Series Module**  
 300 Amperes/1200 Volts

