

Data sheet | Item number: 288-508

Relay module; Nominal input voltage: 230 VAC; 1 changeover contact; 2,50 mm²; gray

www.wago.com/288-508

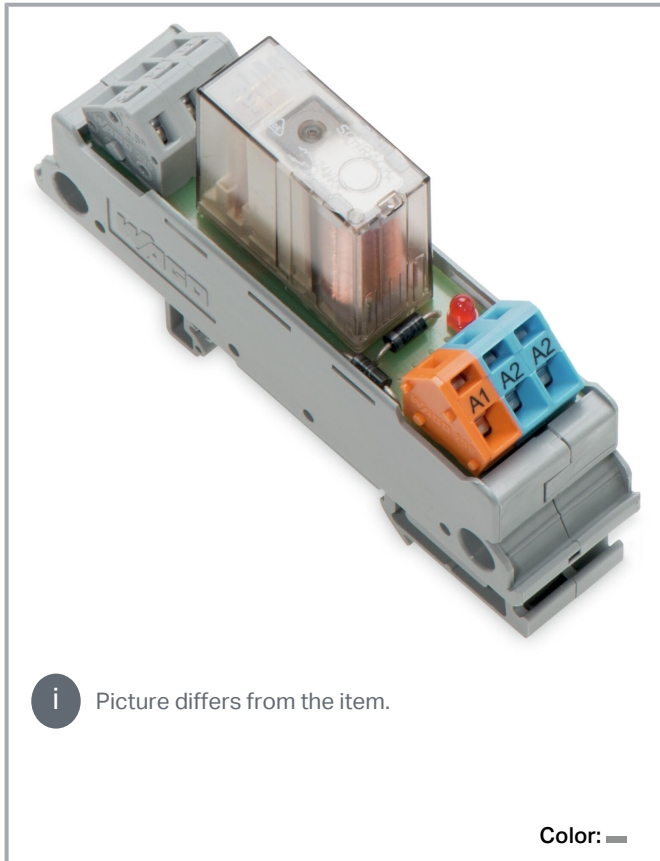

i Picture differs from the item.

Color: —

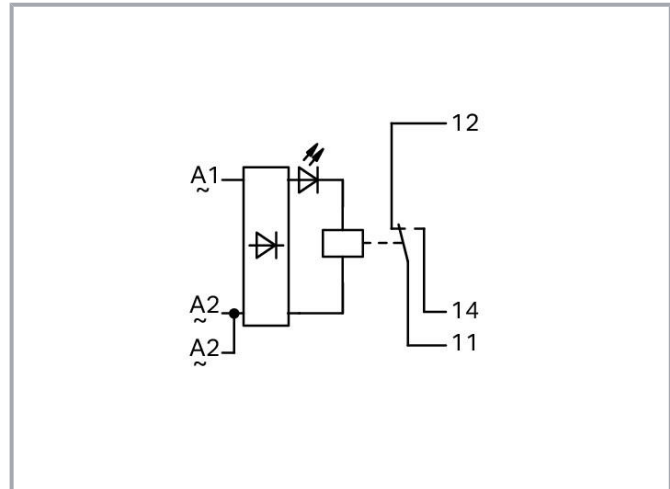

Subject to changes. Please also observe the further product documentation!

WAGO Kontakttechnik GmbH & Co. KG
Hansastr. 27
32423 Minden
Phone: +49571 887-0 | Fax: +49571 887-169
Email: info.de@wago.com | Web: www.wago.com

Do you have any questions about our products?
We are always happy to take your call at +49 (571) 887-44222.

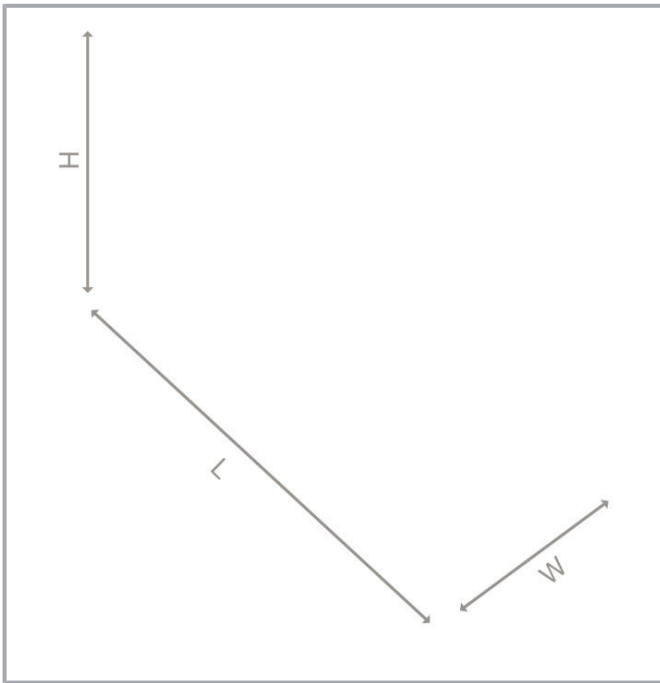

Data

Technical data

Control circuit

Nominal input voltage U_N	AC 230 V
Input voltage range	$\pm 10\%$
Nominal input current at U_N	6.1 mA

Load circuit

Number of changeover/switchover contacts	1
Contact material (relay)	AgNi 90/10
Limiting continuous current	6 A
Inrush current (resistive) (max.)	(AC) 16 A / 4 s
Switching voltage (max.)	AC 250 V
Switching power (resistive) (max.)	AC 1500 VA
Pull-in time (typ.)	9 ms
Drop-out time (typ.)	3 ms
Bounce time (typ.)	2 ms
Electrical life (NO; resistive load; 23 °C)	

Subject to changes. Please also observe the further product documentation!



	100 x 10 ³ switching operations
Mechanical life	30 x 10 ⁶ switching operations

Safety and protection

Rated voltage	300 V
Rated surge voltage	2.5 kV
Pollution degree	2
Dielectric strength, control/load circuit (AC, 1 min)	4 kVrms
Dielectric strength, open contact (AC, 1 min)	1 kVrms

Connection data

Connection technology	CAGE CLAMP®
WAGO Connector	WAGO 236 Series
Solid conductor	0.08 ... 2.5 mm ² / 28 ... 12 AWG
Fine-stranded conductor	0.08 ... 2.5 mm ² / 28 ... 12 AWG
Strip length	5 ... 6 mm / 0.2 ... 0.24 inch

Physical data

Width	20.5 mm / 0.807 inch
Height	85 mm / 3.346 inch
Depth from upper edge of DIN-rail	48 mm / 1.89 inch

Mechanical data

Mounting type	DIN-35 rail
---------------	-------------

Material data

Color	gray
Fire load	0.492 MJ
Weight	40.4 g

Environmental requirements

Surrounding air temperature (operation at U _N)	-25 ... 40 °C
Surrounding air temperature (storage)	-40 ... 80 °C
Processing temperature	-25 ... +50 °C

Subject to changes. Please also observe the further product documentation!

Standards and specifications

Standards/Specifications	EN 60664-1
--------------------------	------------

Commercial data

Product Group	6 (Interface Electronics)
PU (SPU)	10 (1) Stück
Packaging type	box
Country of origin	DE
GTIN	4045454192686
Customs tariff number	85364900990

Optional accessories



Tool

Operating tool

	Item no.: 210-720 Operating tool; Blade: 3.5 x 0.5 mm; with a partially insulated shaft; multicoloured	www.wago.com/210-720
----------------------------------------------------------------------------------	------------------------------------------------------------------------------------------------------------------	----------------------------------------------------------------

Marking accessories

Marking strip

	Item no.: 709-196 Marking strips; for laser printer; translucent	www.wago.com/709-196
	Item no.: 709-178 Marking strips; on reel; 7.5 mm wide; not stretchable; plain; snap-on type; white	www.wago.com/709-178
	Item no.: 709-177 Marking strips; on reel; 7.5 mm wide; not stretchable; plain; snap-on type; translucent	www.wago.com/709-177

Downloads

Documentation

Instruction Leaflet

pdf
1.3 MB Download

Additional Information

Disposal; Electrical and electronic equipment, Packaging V 1.0.0 pdf Download

Subject to changes. Please also observe the further product documentation!

WAGO Kontakttechnik GmbH & Co. KG
Hansastr. 27
32423 Minden
Phone: +49571 887-0 | Fax: +49571 887-169
Email: info.de@wago.com | Web: www.wago.com

Do you have any questions about our products?
We are always happy to take your call at +49 (571) 887-44222.

CAD/CAE-Data

CAD data

2D/3D Models 288-508	URL	Download
----------------------	---------------------	--------------------------

CAE data

EPLAN Data Portal 288-508	URL	Download
---------------------------	---------------------	--------------------------

WSCAD Universe 288-508	URL	Download
------------------------	---------------------	--------------------------

ZUKEN Portal 288-508	URL	Download
----------------------	---------------------	--------------------------

Environmental Product Compliance

Compliance Search

Environmental Product Compliance 288-508	URL	Download
------------------------------------------	---------------------	--------------------------

Relay module; Nominal input voltage: 230 VAC; 1 changeover contact; 2,50 mm²; gray

Installation Notes

Inserting a conductor

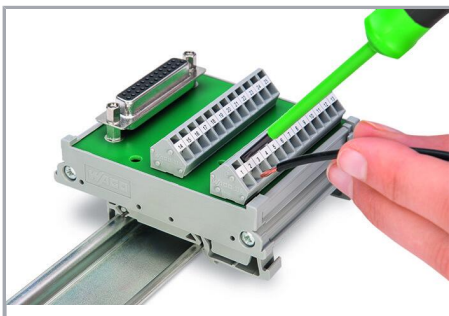

Conductor termination – screwdriver actuation parallel to conductor entry

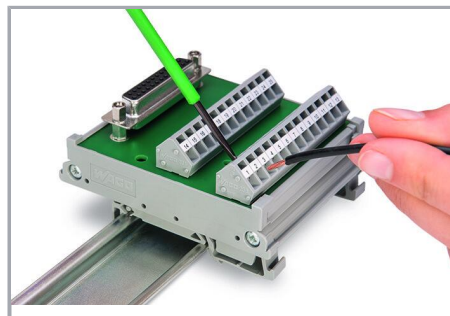

Conductor termination – screwdriver actuation perpendicular to conductor entry

Installation

Subject to changes. Please also observe the further product documentation!

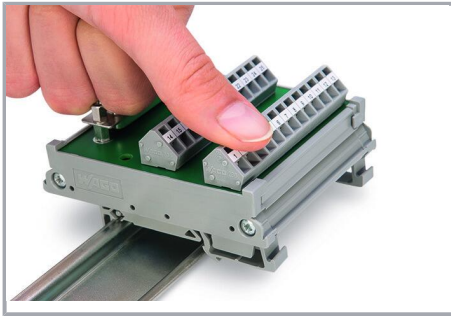

Snapping a module onto DIN-rail.

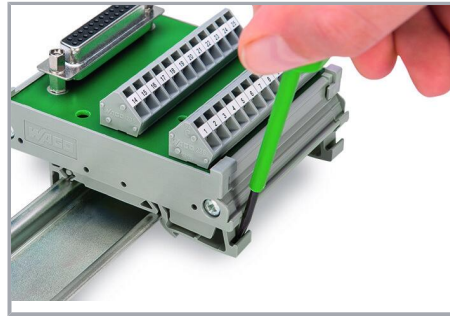

Removing a module from the DIN-rail.

Subject to changes. Please also observe the further product documentation!