

1. Scope

This specification covers the characteristics of the SAW Duplexer ACTF45-48/44.25-48.24/W2 used for cordless telephones.

2. Package

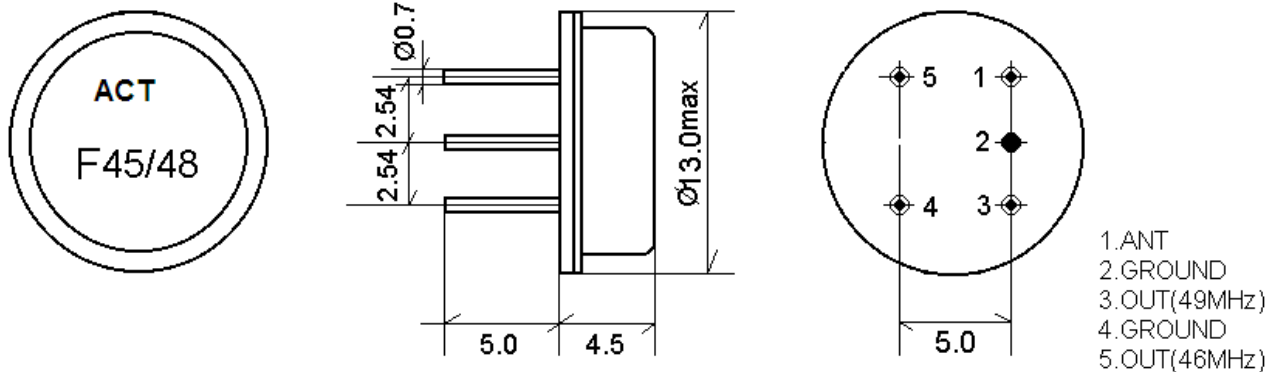

3. Characteristics

Standard atmospheric conditions

Unless otherwise specified, the standard range of atmospheric conditions for making measurements and tests is as follows:

- Ambient temperature: 15°C to 35°C
- Relative humidity: 25% to 85%
- Air pressure: 86kPa to 106kPa

Operating temperature range

Operating temperature range is the range of ambient temperatures in which the filter can be operated continuously. -10°C ~ +50°C

Storage temperature rang

Storage temperature range is the range of ambient temperatures in which the filter can be stored without damage.

Conditions are as specified elsewhere in these specifications. -40°C ~ +70°C

Reference temperature +25°C

3.1 Maximum Rating

DC voltage	V_{DC}	0	V
Source power	P_s	15	dBm

In keeping with our ongoing policy of product evolution and improvement, the above specification is subject to change without notice.

ISO9001: 2000 Registered - Registration number 6830/2

For quotations or further information please contact us at:
 3 The Business Centre, Molly Millars Lane, Wokingham, Berks, RG41 2EY, UK

<http://www.actcrystals.com>

Issue : 1 C1

Date : SEPT 04

3.2 Electrical Characteristics

Characteristics of channel 46:

Reference temperature: $T_A=25^{\circ}\text{C}$
 Source impedance: $Z_S=50\Omega$
 Load impedance: $Z_L=50\Omega$

Item	Freq	min.	typ.	max.	Units
Nominal frequency	f_N	-	45.24	-	MHz
Insertion attenuation 45.00~45.48MHz			4.5	6.0	dB
Attenuation	20.00~41.50MHz	30.0	35.0		dB
	48.00~48.48MHz	40.0	47.0		
	48.48~80.00MHz	30.0	35.0		
Temperature coefficient			-72		ppm/k

Characteristics of channel 49:

Reference temperature: $T_A=25^{\circ}\text{C}$
 Source impedance: $Z_S=50\Omega$
 Load impedance: $Z_L=50\Omega$

Item	Freq	min.	typ.	max.	Units
Nominal frequency	f_N	-	48.24	-	MHz
Insertion attenuation 48.00 ~48.48MHz			4.5	6.0	dB
Attenuation	20.00~45.00MHz	30.0	35.0		dB
	45.00~45.48MHz	40.0	47.0		
	51.50~80.00MHz	30.0	35.0		
Temperature coefficient			-72		ppm/k

Isolation between 46 and 49:

Reference temperature: $T_A=25^{\circ}\text{C}$
 Source impedance: $Z_S=50\Omega$
 Load impedance: $Z_L=50\Omega$

Item	Freq	min.	typ.	max.	Units
Attenuation	45.00~45.48MHz	40.0	48.0		dB
	48.00~48.48MHz	38.0	44.0		

In keeping with our ongoing policy of product evolution and improvement, the above specification is subject to change without notice.

ISO9001: 2000 Registered - Registration number 6830/2

For quotations or further information please contact us at:

3 The Business Centre, Molly Millars Lane, Wokingham, Berks, RG41 2EY, UK

<http://www.actcrystals.com>

Issue : 1 C1

Date : SEPT 04

3.3 Environmental Performance Characteristics

Item Test Condition	Allowable change of absolute Level at centre frequency (dB)
High temperature test 70°C16H	< 1.0
Low temperature test -25°C 2H	< 1.0
Humidity test 40• 90-95% 100H	< 1.0
Thermal cycle -25°C==25°C==70°C 3cycle 30min. 5min. 30min.	< 1.0
Solder temperature test Sold temp.260°C for 10 sec.	< 1.0
Soldering Immerse the pins melt solder At 260°C+5/-0°C for 5 sec.	More then 95% of total area of the pins should be covered with solder

3.4 Mechanical Test

Item Test Condition	Allowable change of absolute Level at centre frequency (dB)
Vibration test Frequency 10~55Hz amplitude 1.5mm 3 directions 2 H each	<1.0
Drop test On maple plate from 1 m high 3 times	<1.0
Lead pull test Pull with 1 kg force for 30 seconds	<1.0
Lead bend test 90° bending with 500g weigh 2 times	<1.0

3.5 Voltage Discharge Test

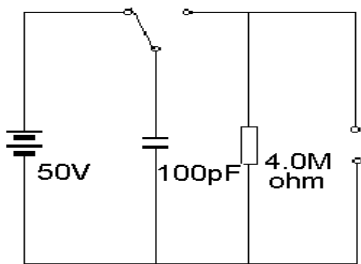
Item Test Condition	Allowable change of absolute Level at centre frequency (dB)
Surge test Between any two electrode 	<1.0

In keeping with our ongoing policy of product evolution and improvement, the above specification is subject to change without notice.

ISO9001: 2000 Registered - Registration number 6830/2

For quotations or further information please contact us at:

3 The Business Centre, Molly Millars Lane, Wokingham, Berks, RG41 2EY, UK

<http://www.actcrystals.com>

Issue : 1 C1

Date : SEPT 04

3.6 Frequency Response

Transfer function channel 45:

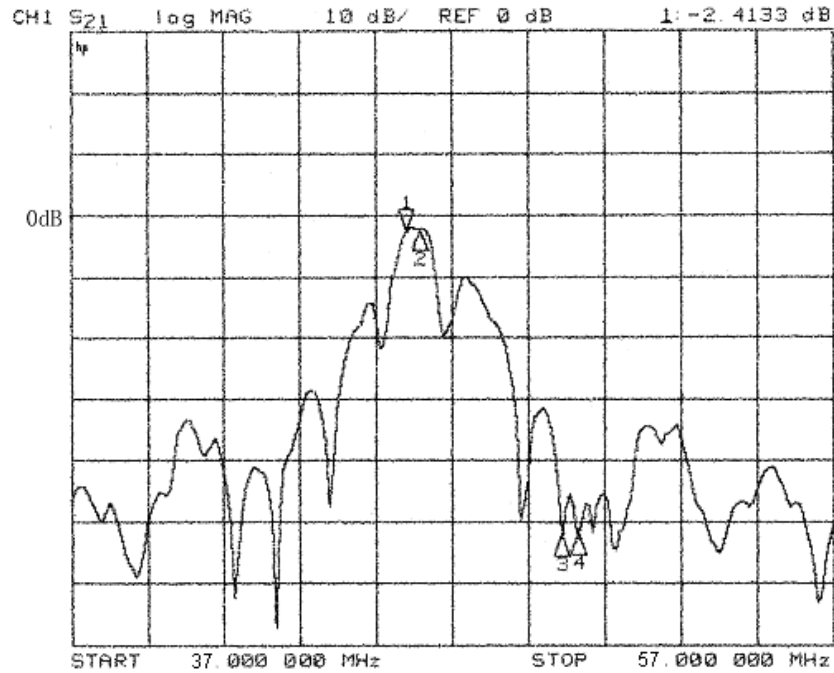

Transfer function channel 45 (pass band):

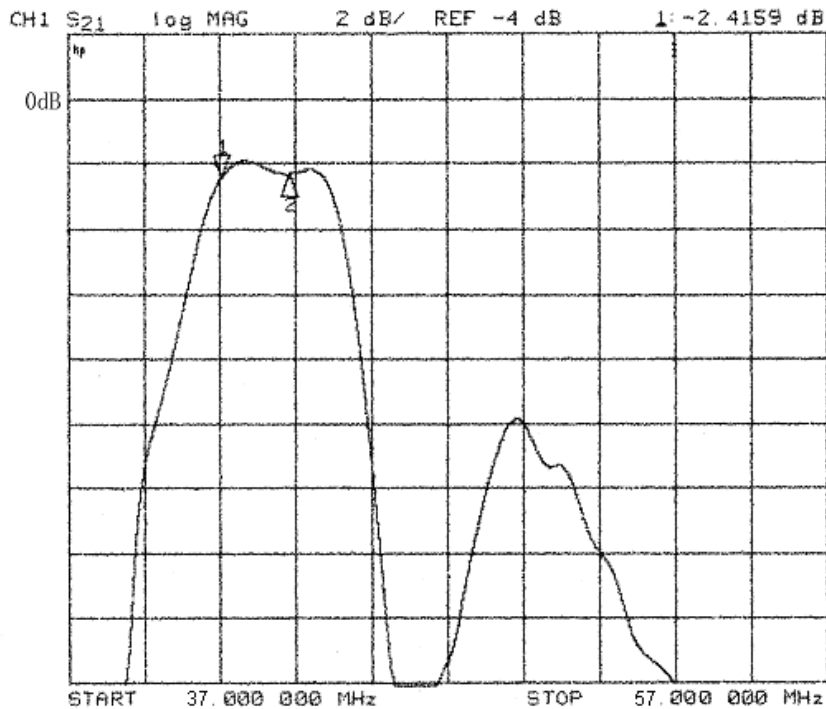

In keeping with our ongoing policy of product evolution and improvement, the above specification is subject to change without notice.

ISO9001: 2000 Registered - Registration number 6830/2

For quotations or further information please contact us at:

3 The Business Centre, Molly Millars Lane, Wokingham, Berks, RG41 2EY, UK

<http://www.actcrystals.com>

Issue : 1 C1

Date : SEPT 04

Transfer function channel 48:

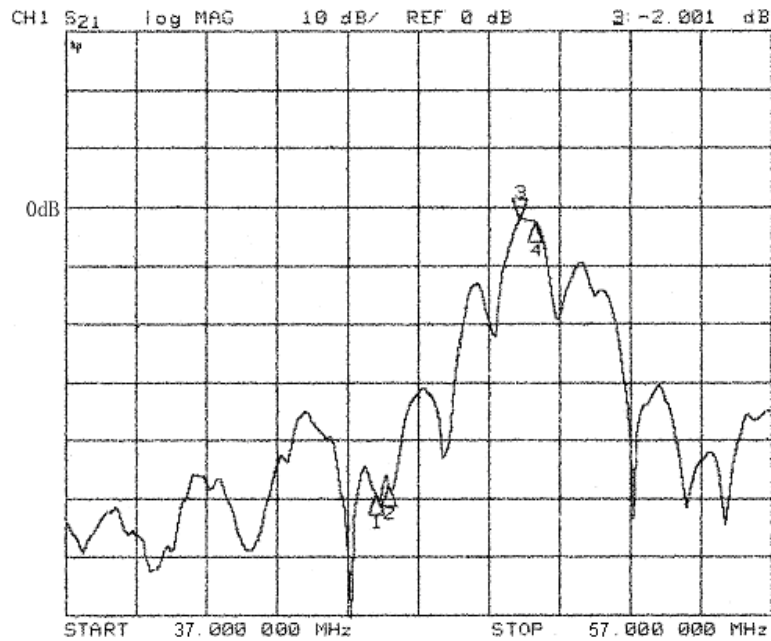

Transfer function channel 48 (pass band):

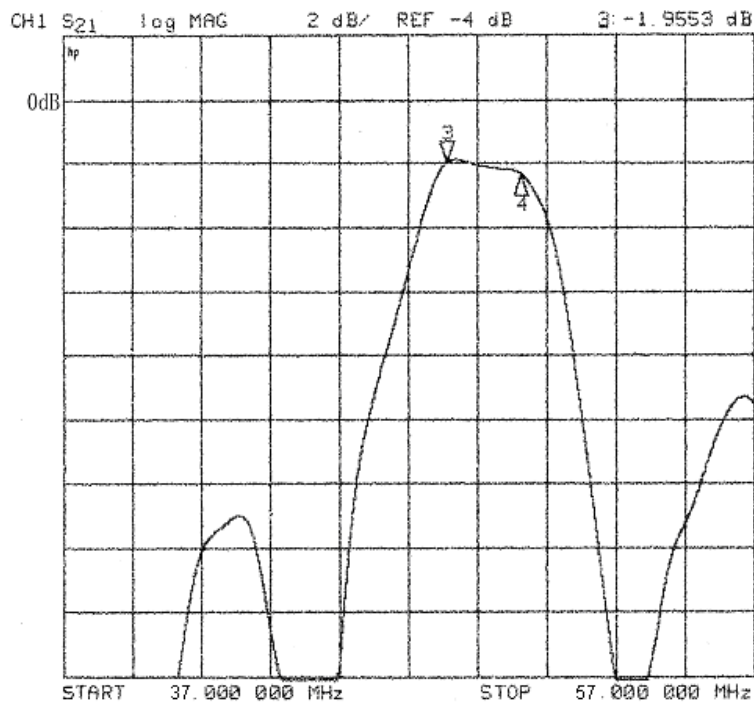

In keeping with our ongoing policy of product evolution and improvement, the above specification is subject to change without notice.

ISO9001: 2000 Registered - Registration number 6830/2

For quotations or further information please contact us at:

3 The Business Centre, Molly Millars Lane, Wokingham, Berks, RG41 2EY, UK

<http://www.actcrystals.com>

Issue : 1 C1

Date : SEPT 04

Isolation between 45 and 48:

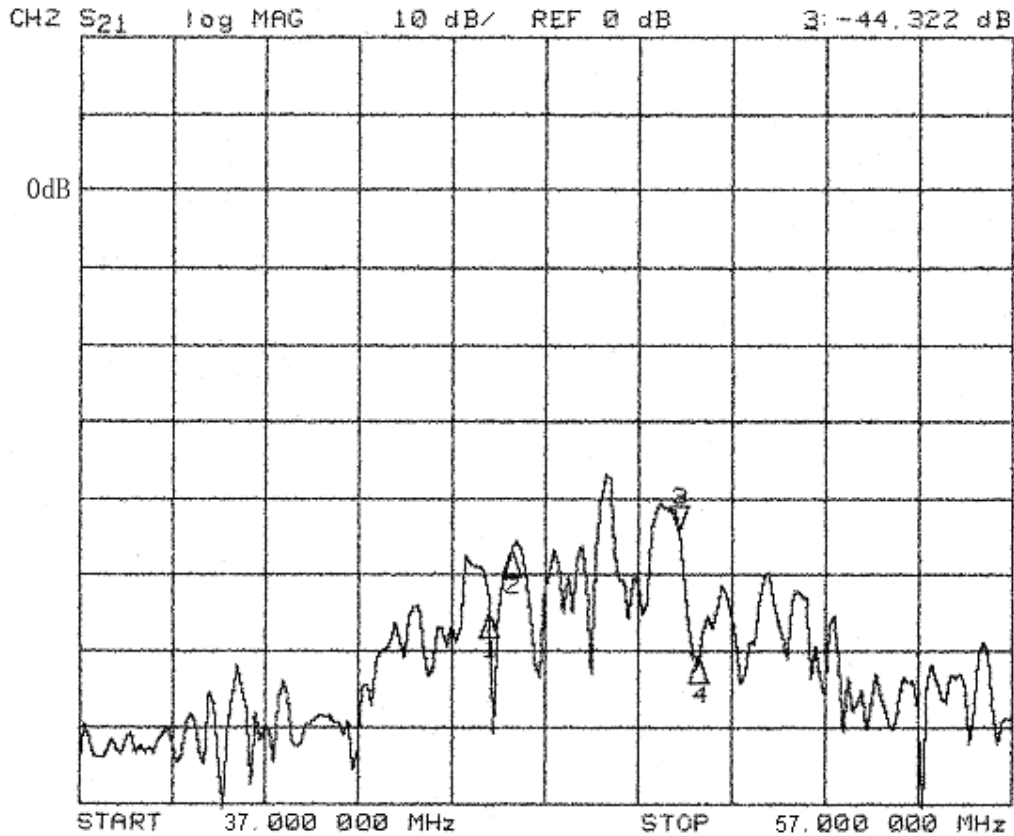

! CAUTION: Electrostatic Sensitive Device. Observe precautions for handling!

1. Unless noted otherwise, specifications apply over the entire specified operating temperature range.
2. The specifications of this device are subject to change or obsolescence without notice.
3. All equipment designs utilizing this product must be approved by the appropriate government agency prior to manufacture or sale.
4. Our liability is only assumed for the Surface Acoustic Wave (SAW) component(s) per se, not for applications, processes and circuits implemented within components or assemblies.

In keeping with our ongoing policy of product evolution and improvement, the above specification is subject to change without notice.

ISO9001: 2000 Registered - Registration number 6830/2

For quotations or further information please contact us at:

3 The Business Centre, Molly Millars Lane, Wokingham, Berks, RG41 2EY, UK

<http://www.actcrystals.com>

Issue : 1 C1

Date : SEPT 04