

12-16GHz Integrated Down Converter

GaAs Monolithic Microwave IC in SMD leadless package

Description

The CHR3352-QEG is a multifunction monolithic circuit, which integrates a balanced cold FET mixer, a LO buffer and a RF LNA including gain control.

It is designed for a wide range of applications, typically ISM and commercial communication systems.

The circuit is manufactured with a pHEMT process, 0.25 μ m gate length, via holes through the substrate, air bridges and electron beam gate lithography.

It is supplied in RoHS compliant SMD package.

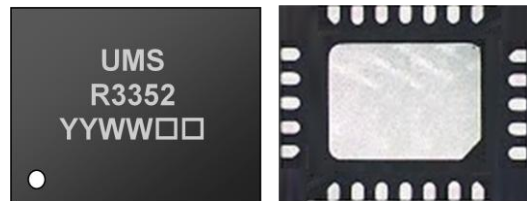

Main Features

- Broadband RF performance 12-16GHz
- 13dB conversion gain
- 2dBm Input IP3
- 9dB Gain Control
- 15dBc Image Rejection
- 24LQFN4x5 – MSL1
- ESD protected

Gain versus attenuation

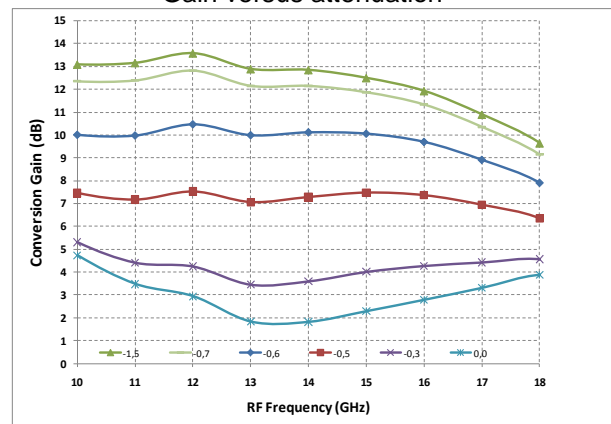

Main Characteristics

Tamb.= +25°C

Symbol	Parameter	Min	Typ	Max	Unit
F _{RF}	RF Frequency range	12		16	GHz
F _{LO}	LO Frequency range	8.5		19.5	GHz
F _{IF}	IF Frequency range	DC		3.5	GHz
G _C	Conversion gain		13		dBm

Main CharacteristicsT_{amb.} = +25°C

Symbol	Parameter	Min	Typ	Max	Unit
FRF	RF frequency range	12		16	GHz
FLO	LO frequency range	8.5		19.5	GHz
FIF	IF frequency range	DC		3.5	GHz
C _G	Conversion gain@ min. attenuation ⁽¹⁾		12		dB
ΔG	Gain control range		9		dB
NF	Noise Figure@ min. attenuation, IF>0.1GHz		2.7		dB
Im_rej	Image rejection ⁽¹⁾		15		dBc
PLO	LO Input power		0		dBm
IIP3	Input IP3@ at Gc max.		2		dBm
LO RL	LO Return Loss		-12		dB
RF RL	RF Return Loss		-12		dB
VD, VDL	DC drain voltage		4.0		V
IDL	LNA current		120		mA
ID	LO Buffer current		130		mA
VG2, 3	LNA DC gate voltage		-0.5		V
B	LO Buffer DC gate voltage		-3		V
IB	LO Buffer DC gate current		-7		mA
GC	Gain control DC voltage	-1.5		0	V

⁽¹⁾ An external combiner 90° is required on I / Q

These values are representative of on-board measurements.

Note: Id is not affected by GC.

Electrostatic discharge sensitive device, observe handling precautions!

Absolute Maximum Ratings ⁽¹⁾T_{amb.} = +25°C

Symbol	Parameter	Values	Unit
VD, VDL	Maximum drain bias voltage	4.5	V
Id _{total}	Maximum drain bias current	420	mA
VGL	LNA DC gate voltage	-2.0 to +0.4	V
B	Buffer, Mixer DC gate voltage	-4	V
GC	Gain control voltage	-2.5 to + 0.8	V
P _{RF}	Maximum peak input power overdrive	10	dBm
P _{LO}	Maximum LO input power	5	dBm
T _{ch}	Maximum channel temperature	175	°C
T _a	Operating temperature range	-40 to +85	°C
T _{stg}	Storage temperature range	-55 to +150	°C

⁽¹⁾ Operation of this device above any one of these parameters may cause permanent damage.

Typical Bias ConditionsT_{amb.} = +25°C

Symbol	Pad N°	Parameter	Values	Unit
VDL, VD	10, 11	DC drain voltages	4	V
IDL	10	LNA current controlled with VG2, 3	120	mA
VG2, 3	8, 9	LNA DC gate voltage	-0.5	V
B	12	Buffer DC gate voltage	-3	V
GC	7	Gain control DC voltage	-1.5 to 0	V

Device thermal performances

All the figures given in this section are obtained assuming that the QFN device is cooled down only by conduction through the package thermal pad (no convection mode considered).

The temperature is monitored at the package back-side interface (T_{case}) as shown below.

The system maximum temperature must be adjusted in order to guarantee that T_{case} remains below than the maximum value specified in the next table. So, the system PCB must be designed to comply with this requirement.

A derating must be applied on the dissipated power if the T_{case} temperature can not be maintained below than the maximum temperature specified (see the curve $P_{diss. Max}$) in order to guarantee the nominal device life time (MTTF).

DEVICE THERMAL SPECIFICATION : CHR3352-QEG	
Recommended max. junction temperature ($T_j \text{ max}$)	: 174 °C
Junction temperature absolute maximum rating	: 175 °C
Max. continuous dissipated power ($P_{diss. Max.}$)	: 1.0 W
=> $P_{diss. Max.}$ derating above $T_{case}^{(1)} = 85$ °C	: 11 mW/°C
Junction-Case thermal resistance ($R_{th J-C}^{(2)}$)	: <89 °C/W
Minimum T_{case} operating temperature ⁽³⁾	: -40 °C
Maximum T_{case} operating temperature ⁽³⁾	: 85 °C
Minimum storage temperature	: -55 °C
Maximum storage temperature	: 150 °C

(1) Derating at junction temperature constant = $T_j \text{ max}$.

(2) $R_{th J-C}$ is calculated for a worst case considering the **hottest junction** of the MMIC and all the devices biased.

(3) T_{case} = Package back side temperature measured under the die-attach-pad (see the drawing below).

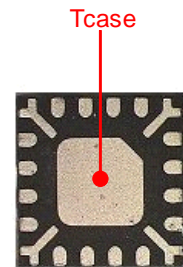
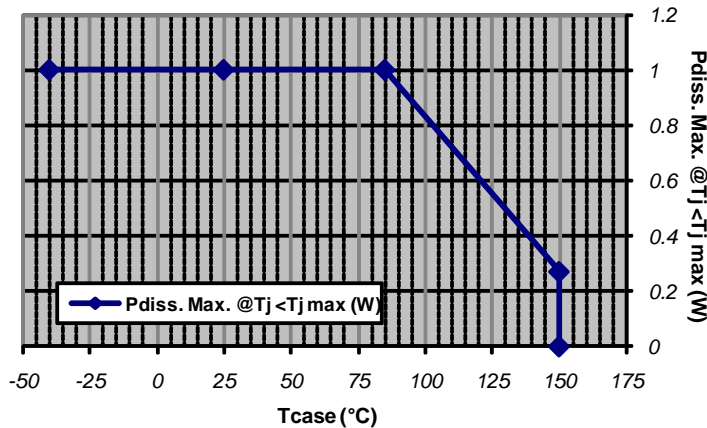

Example: QFN 16L 3x3
Location of temperature reference point (T_{case}) on package's bottom side

6.0

Typical Measured Performances ⁽¹⁾

Tamb = +25°C, VD=VDL= 4V, VG2=VG3= -0.5V, VGM = -0.7V, P_LO = 0dBm
 Board losses de-embedded (result given on package access planes)

Conversion Gain versus RF & IF Frequencies
 RF = LO+ IF, GC = -1.5V & 0V

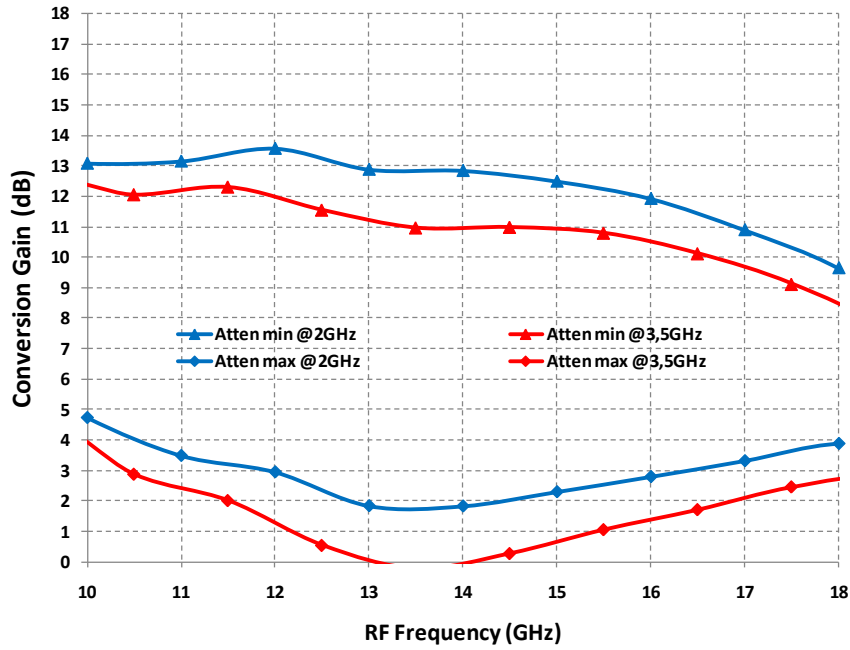

⁽¹⁾ If no specific mention, the following values are representative of onboard measurements (on connector access planes) as defined on the drawing at paragraph [Evaluation mother board](#). The board losses are estimated from 0.8 to 1.2dB in the frequency range.

Typical Measured Performances

Tamb = +25°C, VD=VDL= 4V, VG2=VG3= -0.5V, VGM = -0.7V, P_LO = 0dBm
 Board losses de-embedded (result given on package access planes)

Conversion Gain in Supradynne Mode versus RF Frequency & GC
 RF = LO+ IF, IF = 2GHz

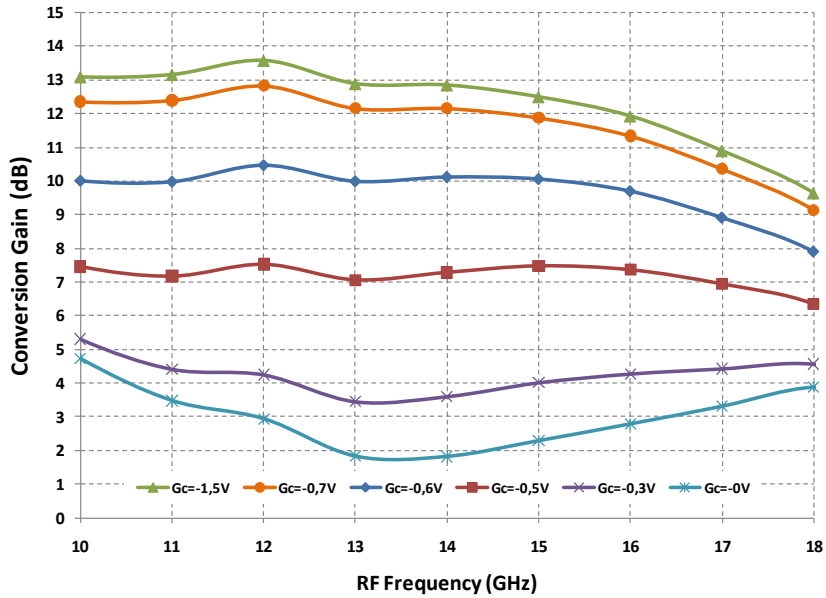

Conversion Gain in infradyne Mode versus RF Frequency & GC
 RF = LO- IF, IF = 2GHz

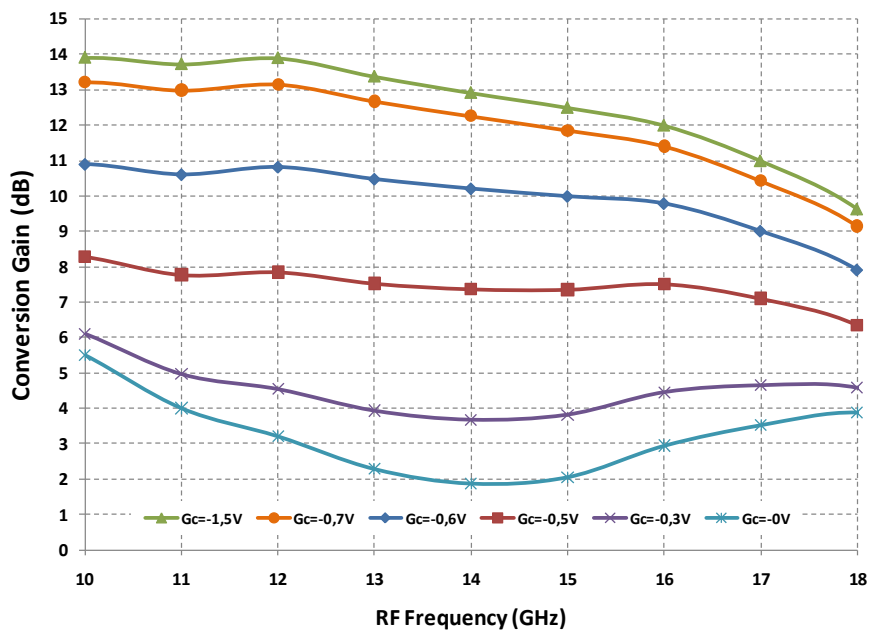

Typical Measured Performances

Tamb = +25°C, VD=VDL= 4V, VG2=VG3= -0.5V, VGM = -0.7V, P_LO = 0dBm
 Board losses de-embedded (result given on package access planes)

Noise Figure versus Frequency
 RF = LO+/- IF, IF = 2GHz, GC = -1.5 & 0V

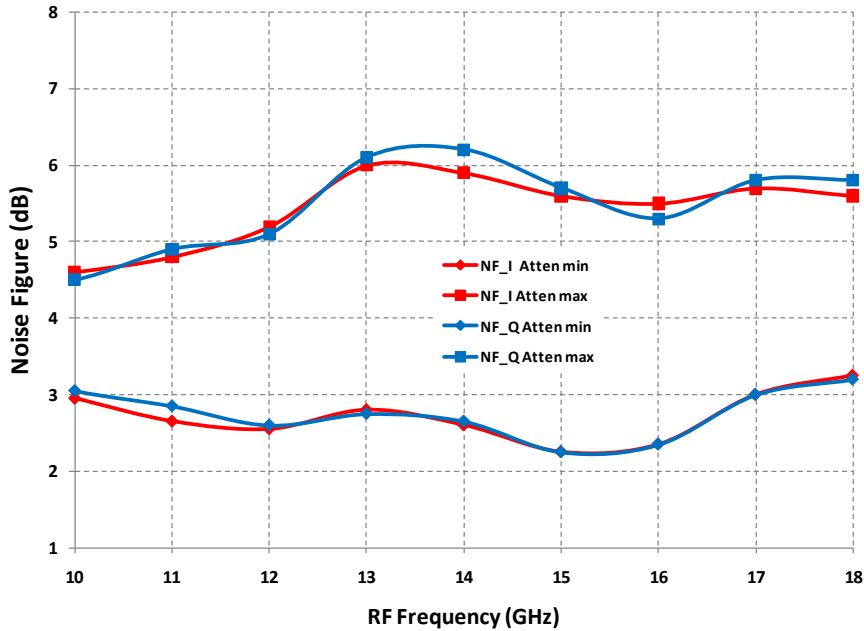

Return loss versus Frequency
 GC = -1.5V

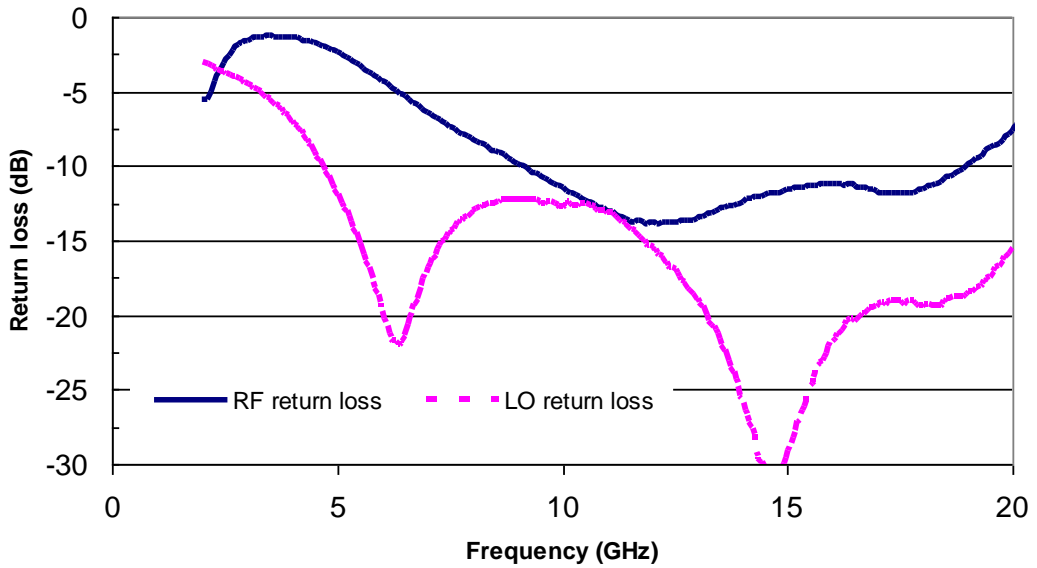

Typical Measured Performances

Tamb = +25°C, VD=VDL= 4V, VG2=VG3= -0.5V, VGM = -0.7V, P_LO = 0dBm
 Board losses de-embedded (result given on package access planes)

Image Rejection versus frequency
 RF = LO+/- IF, IF = 2GHz, GC = -1.5V

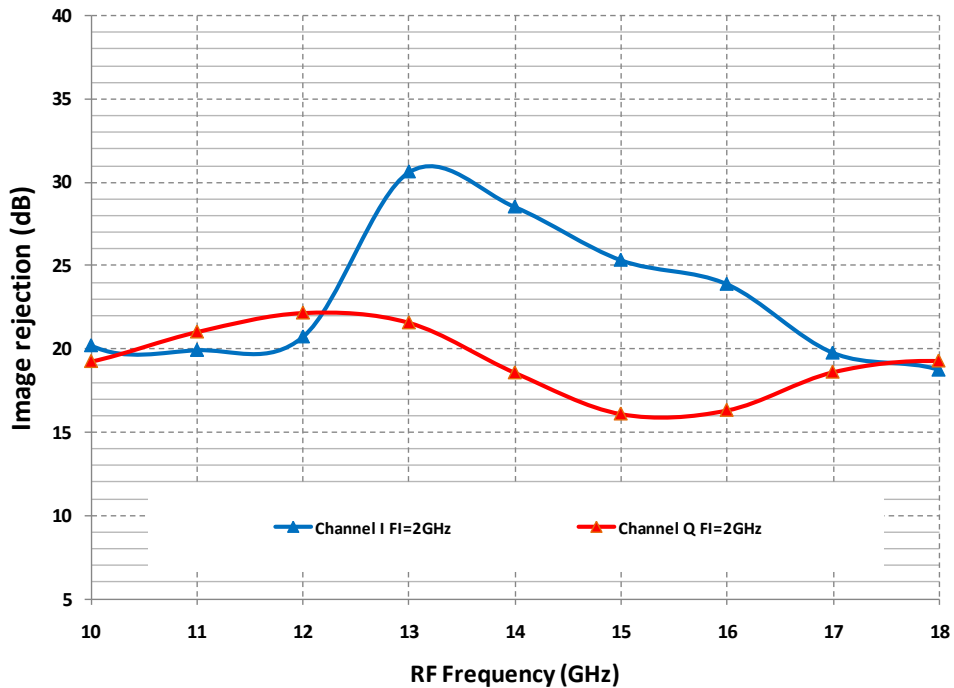
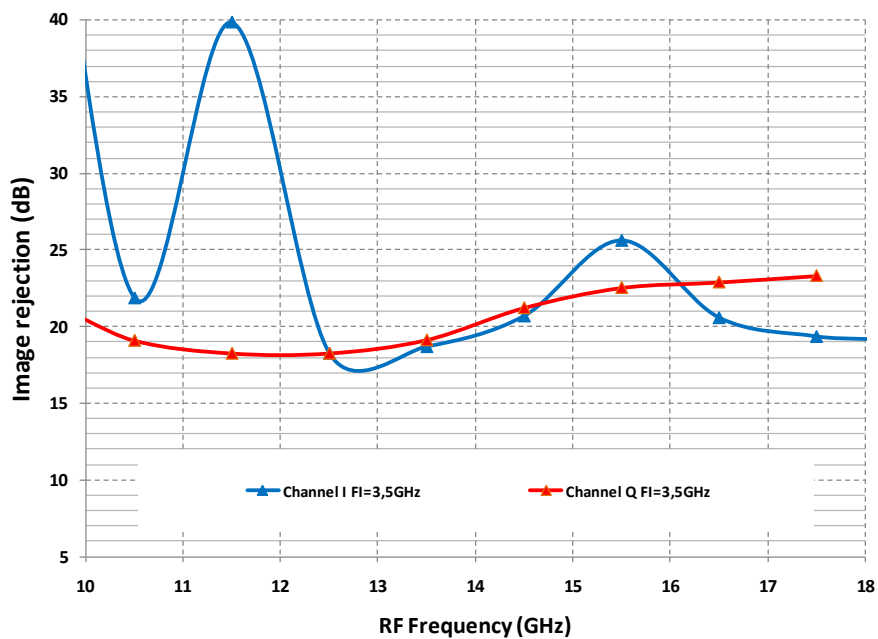

Image Rejection versus Frequency
 RF = LO+/- IF, IF = 3.5GHz, GC = -1.5V



Typical Measured Performances

Tamb = +25°C, VD=VDL= 4V, VG2=VG3= -0.5V, VGM = -0.7V, P_LO = 0dBm
 Board losses de-embedded (result given on package access planes)

Input IP3 versus Freq. at GC = -1.5V

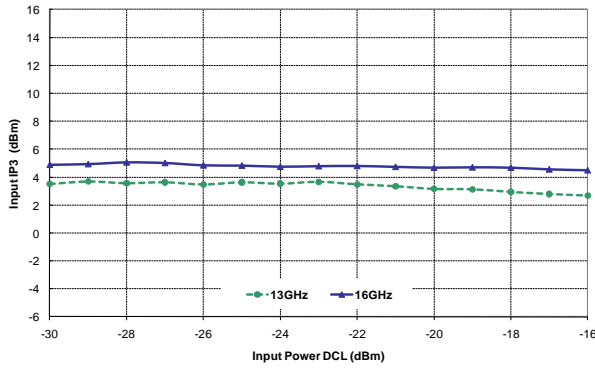

IMD3 versus Freq. at GC = -1.5V

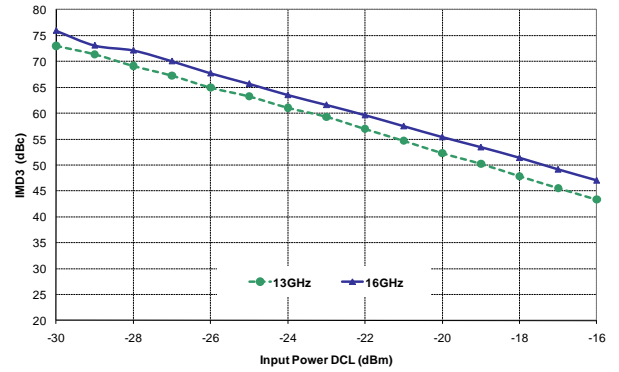

Input IP3 versus GC at 16GHz

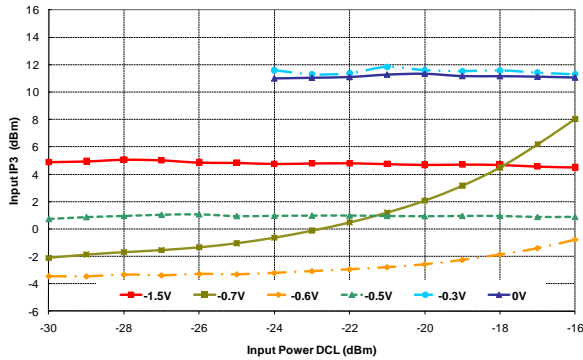

Input IP3 vs temperature at 13GHz

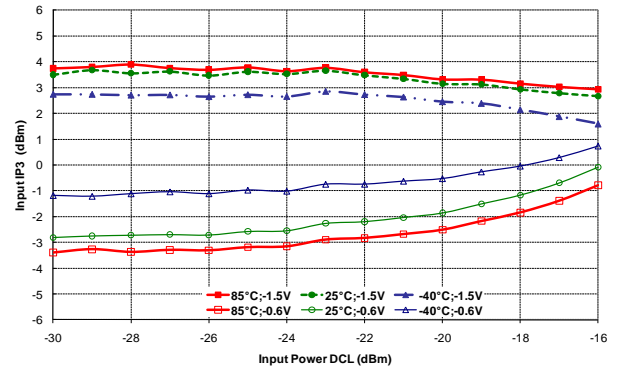

Typical Measured Performances

Tamb = +25°C, Tcold = -40°C, Thot = +85°C

VD=VDL= 4V, VG2=VG3= -0.5V, VGM = -0.7V, P_LO = 0dBm

Board losses de-embedded (result given on package access planes)

Conversion Gain vs Temperature

IF = 2GHz, GC = -1.5V & 0V

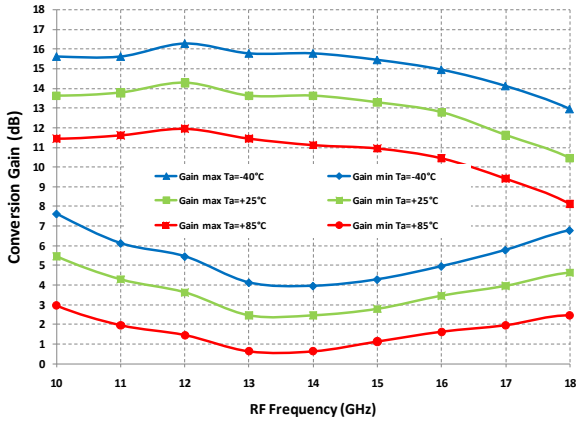

Conversion Gain vs Temperature

IF = 3.5GHz, GC = -1.5V & 0V

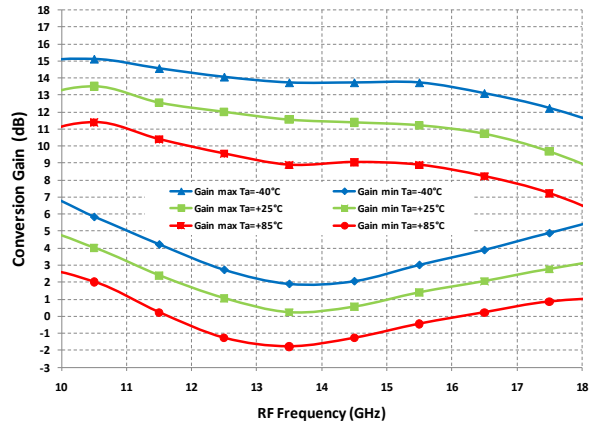

Noise figure vs Temperature

Supradynne, IF = 2GHz, GC = -1.5V

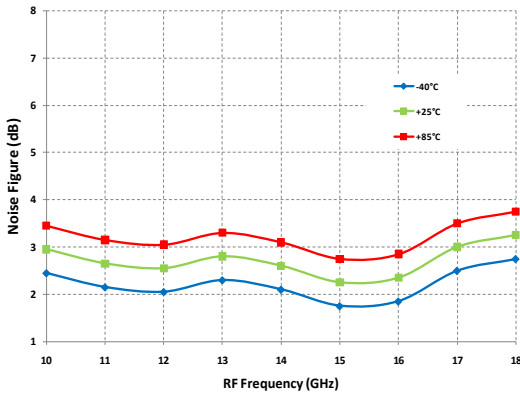

Noise figure vs Temperature

Infradyne, IF = 2GHz, GC = -1.5V

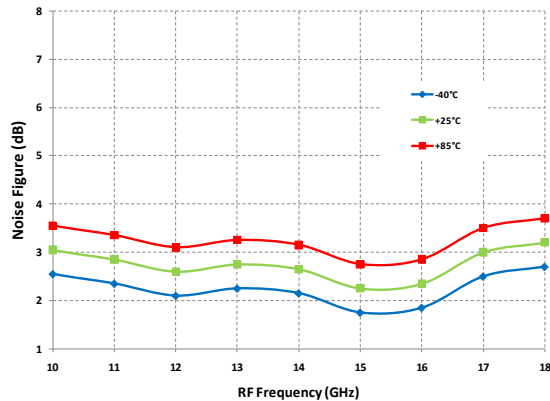

Spurious on IF outputs

P_RF = -20dBm / P_LO = 0dBm @12GHz

mRF	nLO				
	0	1	2	3	4
0	Xx	12	9	22	>40
1	26	24	>40	32	>40
2	39	>40	37	>40	>40
3	33	>40	>40	>40	>40
4	>40	>40	>40	>40	>40

All values in dBc below IF power level (IF = 1GHz).

Data measured without external hybrid coupler.

Package outline ⁽¹⁾

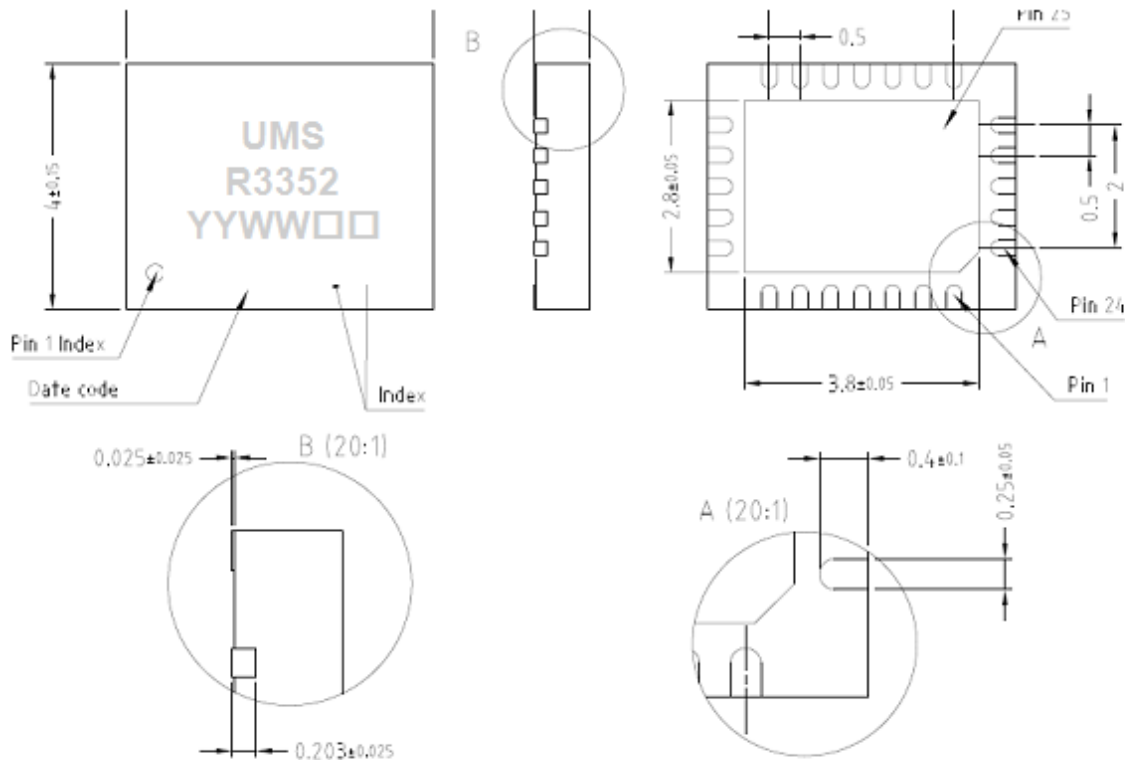

Matt tin, Lead Free (Green)	1- Nc	9- VG3	17- Nc
Units : mm	2- Nc	10- VDL	18- Nc
From the standard : JEDEC MO-220 (VGGD)	3- Nc	11- VD	19- Nc
25- GND	4- Gnd ⁽²⁾	12- B	20- IF_I
	5- RF in	13- Nc	21- Gnd ⁽²⁾
	6- Nc	14- Nc	22- IF_Q
	7- GC	15- LO in	23- Nc
	8- VG2	16- Gnd ⁽²⁾	24- Nc

⁽¹⁾ The package outline drawing included to this data-sheet is given for indication. Refer to the application note AN0017 (<http://www.ums-gaas.com>) for exact package dimensions.

⁽²⁾ It is strongly recommended to ground all pins marked “Gnd” through the PCB board. Ensure that the PCB board is designed to provide the best possible ground to the package.

Due to ESD protection circuits on RF input and output, an external capacitance might be requested to isolate the product from external voltage that could be present on the RF accesses.

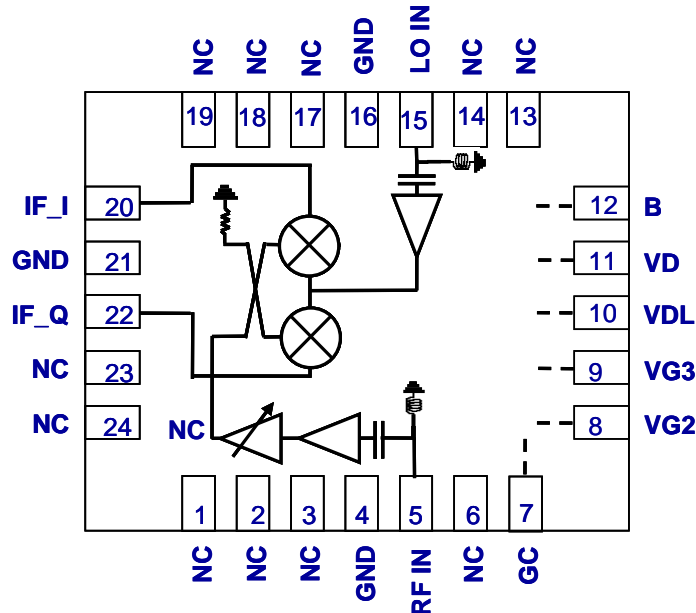

ESD protections are also implemented on gate and control accesses.

The DC connections do not include any decoupling capacitor in package, therefore it is mandatory to provide a good external DC decoupling (10nF) on the PC board, as close as possible to the package.

Evaluation mother board

- Compatible with the proposed footprint.
- Based on typically Ro4003 / 8mils or equivalent.
- Using a micro-strip to coplanar transition to access the package.
- Recommended for the implementation of this product on a module board.
- Decoupling capacitors of 10nF \pm 10% are recommended for all DC accesses.
- See application note AN0017 for details.
- Hybrid coupler 90° ; 2- 4GHz

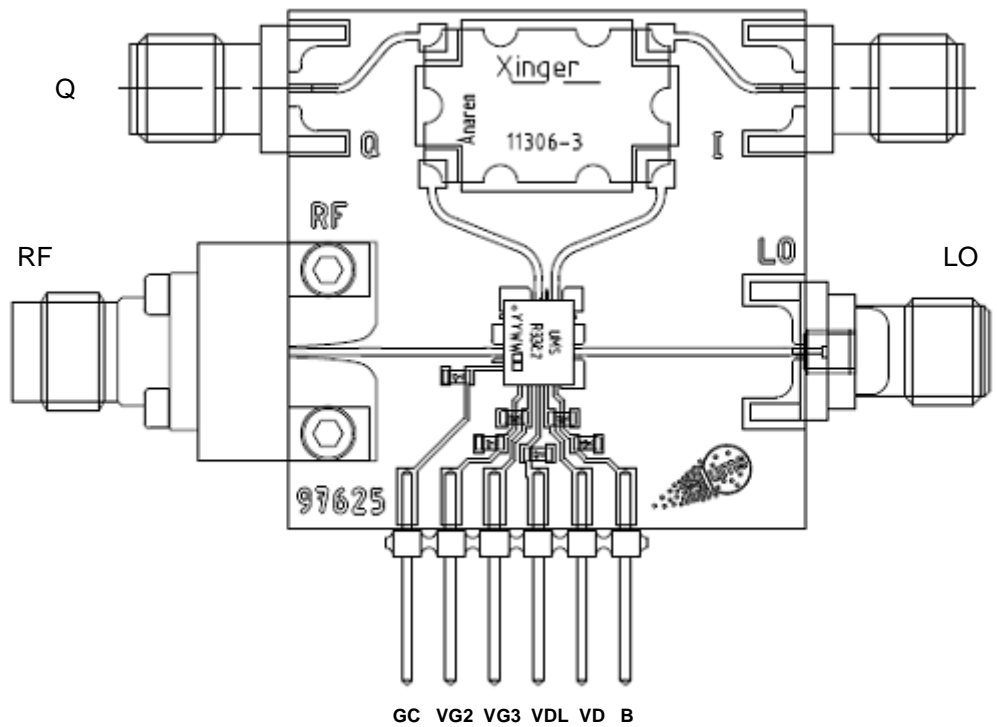

Notes

Recommended package footprint

Refer to the application note AN0017 available at <http://www.ums-gaas.com> for package footprint recommendations.

SMD mounting procedure

For the mounting process standard techniques involving solder paste and a suitable reflow process can be used. For further details, see application note AN0017.

Recommended environmental management

Refer to the application note AN0019 available at <http://www.ums-gaas.com> for environmental data on UMS package products.

Recommended ESD management

Refer to the application note AN0020 available at <http://www.ums-gaas.com> for ESD sensitivity and handling recommendations for the UMS package products.

Ordering Information

QFN 4x5 RoHS compliant package:

CHR3352-QEG/XY

Stick: XY = 20

Tape & reel: XY = 21

Information furnished is believed to be accurate and reliable. However **United Monolithic Semiconductors S.A.S.** assumes no responsibility for the consequences of use of such information nor for any infringement of patents or other rights of third parties which may result from its use. No license is granted by implication or otherwise under any patent or patent rights of **United Monolithic Semiconductors S.A.S.** Specifications mentioned in this publication are subject to change without notice. This publication supersedes and replaces all information previously supplied. **United Monolithic Semiconductors S.A.S.** products are not authorised for use as critical components in life support devices or systems without express written approval from **United Monolithic Semiconductors S.A.S.**