

SPHV Series 200W Discrete Unidirectional TVS Diode  **AUTOMOTIVE GRADE**  **RoHS**  **Pb**  **GREEN**

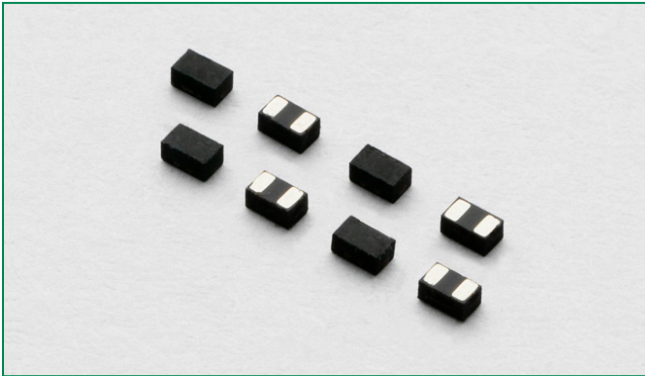

**Description**

The unidirectional SPHV series is designed for use in portable applications, LED lighting modules, automotive applications, and low speed I/Os. It will protect sensitive equipment from damage due to electrostatic discharge (ESD) and other overvoltage transients.

The SPHV series can safely absorb repetitive ESD strikes above the maximum level of the IEC 61000-4-2 international standard (Level 4, ±8kV contact discharge) without performance degradation and safely dissipate up to 8A (SPHV12) of induced surge current (IEC 61000-4-5, 2nd Edition  $t_p=8/20\mu s$ ) with very low clamping voltages.

**Pinout**

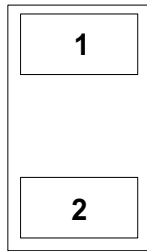

**Features**

- ESD, IEC 61000-4-2, ±30kV contact, ±30kV air
- EFT, IEC 61000-4-4, 40A (5/50ns)
- Lightning, IEC 61000-4-5, 2nd Edition 8A ( $t_p=8/20\mu s$ , SPHV12)
- Low clamping voltage
- Low leakage current
- Small SOD882 packaging helps save board space
- Side exposed leadframe helps to verify solderability (SPHVxx-KTG series)
- AEC-Q101 qualified
- Lead-free, Halogen-free, and RoHS Compliant

**Functional Block Diagram**

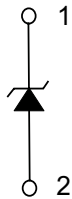

Life Support Note:

**Not Intended for Use in Life Support or Life Saving Applications**

The products shown herein are not designed for use in life sustaining or life saving applications unless otherwise expressly indicated.

**Applications**

- LED Lighting Modules
- Portable Instrumentation
- General Purpose I/O
- Mobile & Handhelds
- RS232 / RS485
- CAN and LIN Bus

**Additional Information**



**Datasheet**



**Resources**



**Samples**

### Absolute Maximum Ratings

Symbol	Parameter	Value	Units
$P_{pk}$	Peak Pulse Power ( $t_p=8/20\mu s$ )	200	W
$T_{OP}$	Operating Temperature	-40 to 125	°C
$T_{STOR}$	Storage Temperature	-55 to 150	°C

Notes:

CAUTION: Stresses above those listed in "Absolute Maximum Ratings" may cause permanent damage to the device. This is a stress only rating and operation of the device at these or any other conditions above those indicated in the operational sections of this specification is not implied.

### Thermal Information

Parameter	Rating	Units
Storage Temperature Range	-55 to 150	°C
Maximum Junction Temperature	150	°C
Maximum Lead Temperature (Soldering 20-40s)	260	°C

### SPHV12 Electrical Characteristics ( $T_{OP}=25^\circ C$ )

Parameter	Symbol	Test Conditions	Min	Typ	Max	Units
Reverse Standoff Voltage	$V_{RWM}$	$I_R \leq 1\mu A$			12.0	V
Reverse Breakdown Voltage	$V_{BR}$	$I_R = 1mA$	13.3			V
Leakage Current	$I_{LEAK}$	$V_R = 12V$			1.0	$\mu A$
Clamp Voltage <sup>1</sup>	$V_C$	$I_{PP} = 1A, t_p = 8/20\mu s, Fwd$			19.0	V
		$I_{PP} = 8A, t_p = 8/20\mu s, Fwd$			25.0	V
Dynamic Resistance <sup>2</sup>	$R_{DYN}$	TLP, $t_p = 100ns, I/O$ to GND		0.37		$\Omega$
Peak Pulse Current	$I_{PP}$	$t_p = 8/20\mu s$			8.0	A
ESD Withstand Voltage <sup>1</sup>	$V_{ESD}$	IEC61000-4-2 (Contact Discharge)	$\pm 30$			kV
		IEC61000-4-2 (Air Discharge)	$\pm 30$			kV
Diode Capacitance <sup>1</sup>	$C_{D-GND}$	Reverse Bias=0V, f=1MHz			60	pF

Note:

<sup>1</sup> Parameter is guaranteed by design and/or device characterization.

<sup>2</sup> Transmission Line Pulse (TLP) with 100ns width and 200ps rise time.

### SPHV15 Electrical Characteristics ( $T_{OP}=25^\circ C$ )

Parameter	Symbol	Test Conditions	Min	Typ	Max	Units
Reverse Standoff Voltage	$V_{RWM}$	$I_R \leq 1\mu A$			15.0	V
Reverse Breakdown Voltage	$V_{BR}$	$I_R = 1mA$	16.7			V
Leakage Current	$I_{LEAK}$	$V_R = 15V$			1.0	$\mu A$
Clamp Voltage <sup>1</sup>	$V_C$	$I_{PP} = 1A, t_p = 8/20\mu s, Fwd$			22.0	V
		$I_{PP} = 5A, t_p = 8/20\mu s, Fwd$			28.0	V
Dynamic Resistance <sup>2</sup>	$R_{DYN}$	TLP, $t_p = 100ns, I/O$ to GND		0.40		$\Omega$
Peak Pulse Current	$I_{PP}$	$t_p = 8/20\mu s$			5.0	A
ESD Withstand Voltage <sup>1</sup>	$V_{ESD}$	IEC61000-4-2 (Contact Discharge)	$\pm 30$			kV
		IEC61000-4-2 (Air Discharge)	$\pm 30$			kV
Diode Capacitance <sup>1</sup>	$C_{I/O-GND}$	Reverse Bias=0V, f=1MHz			46	pF

Note:

<sup>1</sup> Parameter is guaranteed by design and/or device characterization.

<sup>2</sup> Transmission Line Pulse (TLP) with 100ns width and 200ps rise time.

### SPHV24 Electrical Characteristics (T<sub>OP</sub>=25°C)

Parameter	Symbol	Test Conditions	Min	Typ	Max	Units
Reverse Standoff Voltage	V <sub>RWM</sub>	I <sub>R</sub> ≤ 1 μA			24.0	V
Reverse Breakdown Voltage	V <sub>BR</sub>	I <sub>R</sub> = 1 mA	26.7			V
Leakage Current	I <sub>LEAK</sub>	V <sub>R</sub> = 24V			1.0	μA
Clamp Voltage <sup>1</sup>	V <sub>C</sub>	I <sub>PP</sub> = 1A, t <sub>p</sub> = 8/20 μs, Fwd			36.0	V
		I <sub>PP</sub> = 3A, t <sub>p</sub> = 8/20 μs, Fwd			50.0	V
Dynamic Resistance <sup>2</sup>	R <sub>DYN</sub>	TLP, t <sub>p</sub> = 100ns, I/O to GND		0.56		Ω
Peak Pulse Current	I <sub>PP</sub>	t <sub>p</sub> = 8/20 μs			3.0	A
ESD Withstand Voltage <sup>1</sup>	V <sub>ESD</sub>	IEC61000-4-2 (Contact Discharge)	±24			kV
		IEC61000-4-2 (Air Discharge)	±30			kV
Diode Capacitance <sup>1</sup>	C <sub>I/O-GND</sub>	Reverse Bias=0V, f=1MHz			32	pF

Note:

<sup>1</sup> Parameter is guaranteed by design and/or device characterization.

<sup>2</sup> Transmission Line Pulse (TLP) with 100ns width and 200ps rise time.

### SPHV36 Electrical Characteristics (T<sub>OP</sub>=25°C)

Parameter	Symbol	Test Conditions	Min	Typ	Max	Units
Reverse Standoff Voltage	V <sub>RWM</sub>	I <sub>R</sub> ≤ 1 μA			36.0	V
Reverse Breakdown Voltage	V <sub>BR</sub>	I <sub>R</sub> = 1 mA	40.0			V
Leakage Current	I <sub>LEAK</sub>	V <sub>R</sub> = 36V			1.0	μA
Clamp Voltage <sup>1</sup>	V <sub>C</sub>	I <sub>PP</sub> = 1A, t <sub>p</sub> = 8/20 μs, Fwd			52.0	V
		I <sub>PP</sub> = 2A, t <sub>p</sub> = 8/20 μs, Fwd			60.0	V
Dynamic Resistance <sup>2</sup>	R <sub>DYN</sub>	TLP, t <sub>p</sub> = 100ns, I/O to GND		1.28		Ω
Peak Pulse Current	I <sub>PP</sub>	t <sub>p</sub> = 8/20 μs			2.0	A
ESD Withstand Voltage <sup>1</sup>	V <sub>ESD</sub>	IEC61000-4-2 (Contact Discharge)	±15			kV
		IEC61000-4-2 (Air Discharge)	±20			kV
Diode Capacitance <sup>1</sup>	C <sub>I/O-GND</sub>	Reverse Bias=0V, f=1MHz			25	pF

Note:

<sup>1</sup> Parameter is guaranteed by design and/or device characterization.

<sup>2</sup> Transmission Line Pulse (TLP) with 100ns width and 200ps rise time.

### Non-Repetitive Peak Pulse Power vs. Pulse Time

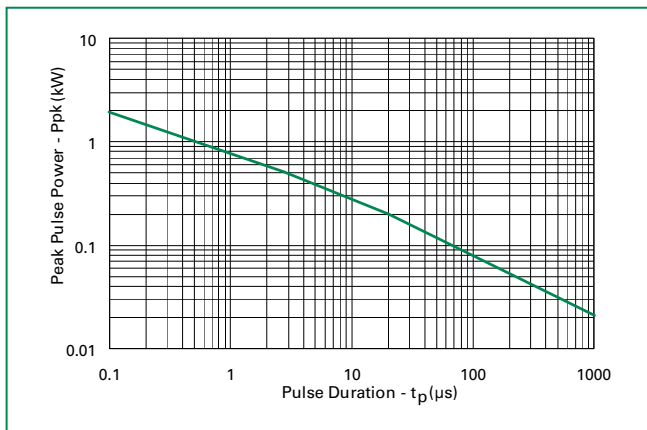

### Power Derating Curve

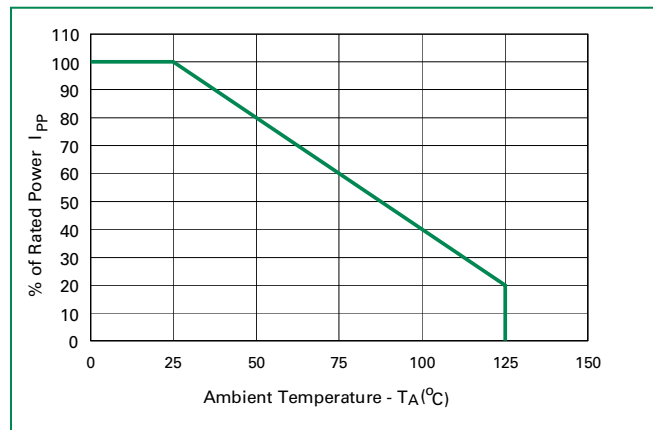

**8/20µs Pulse Waveform**

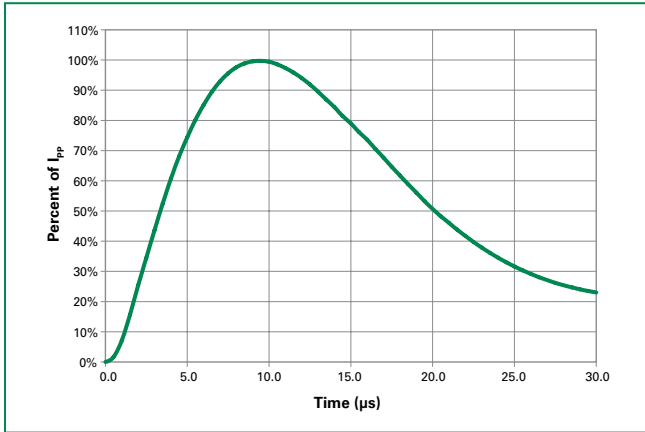

**SPHV12 Transmission Line Pulsing(TLP) Plot**

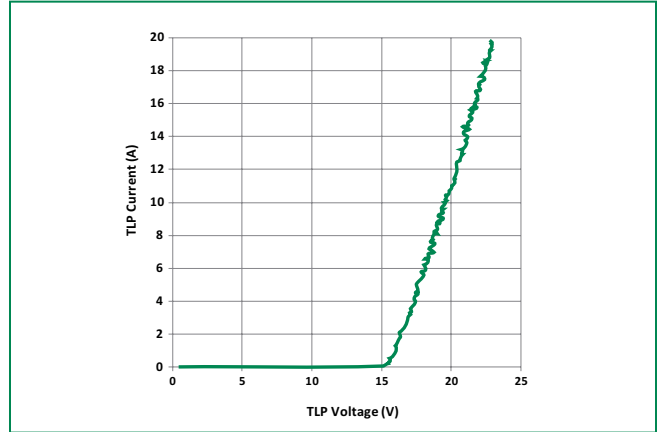

**SPHV15 Transmission Line Pulsing(TLP) Plot**

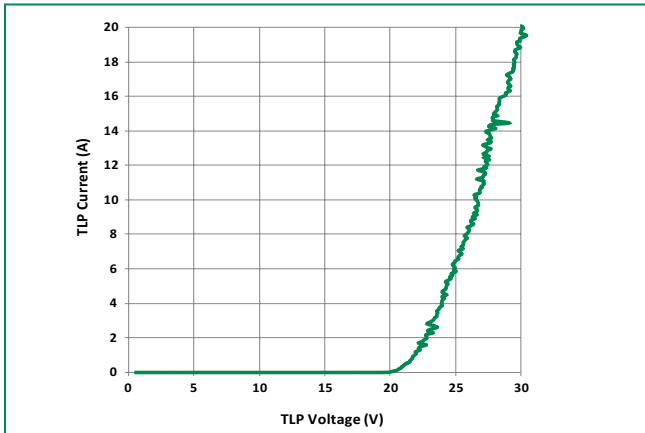

**SPHV24 Transmission Line Pulsing(TLP) Plot**

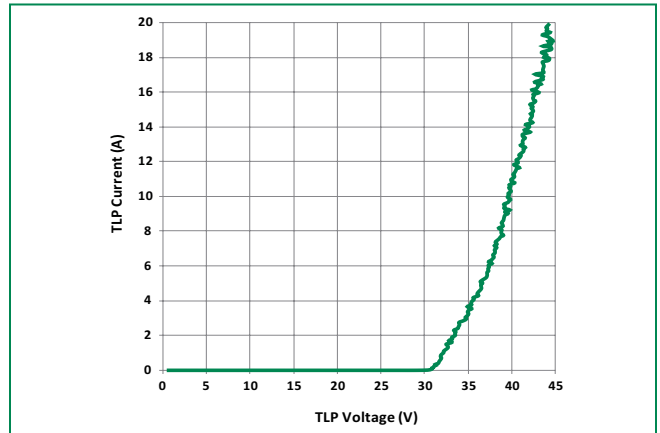

**SPHV36 Transmission Line Pulsing(TLP) Plot**

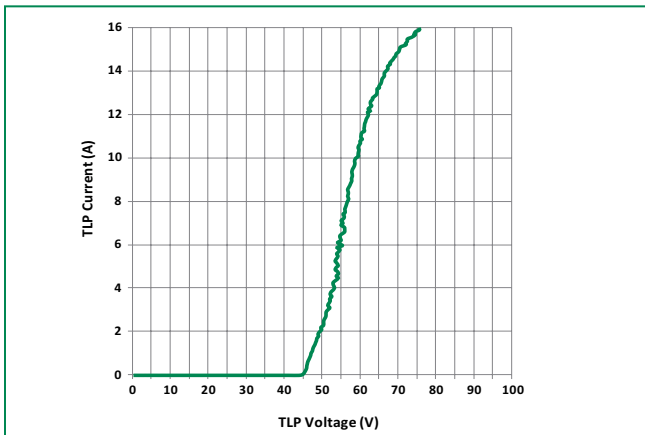

### Soldering Parameters

Reflow Condition		Pb – Free assembly
Pre Heat	- Temperature Min ( $T_{s(min)}$ )	150°C
	- Temperature Max ( $T_{s(max)}$ )	200°C
	- Time (min to max) ( $t_s$ )	60 – 180 secs
Average ramp up rate (Liquidus) Temp ( $T_L$ ) to peak		3°C/second max
$T_{s(max)}$ to $T_L$ - Ramp-up Rate		3°C/second max
Reflow	- Temperature ( $T_L$ ) (Liquidus)	217°C
	- Temperature ( $t_L$ )	60 – 150 seconds
Peak Temperature ( $T_p$ )		260 <sup>+0/-5</sup> °C
Time within 5°C of actual peak Temperature ( $t_p$ )		20 – 40 seconds
Ramp-down Rate		6°C/second max
Time 25°C to peak Temperature ( $T_p$ )		8 minutes Max.
Do not exceed		260°C

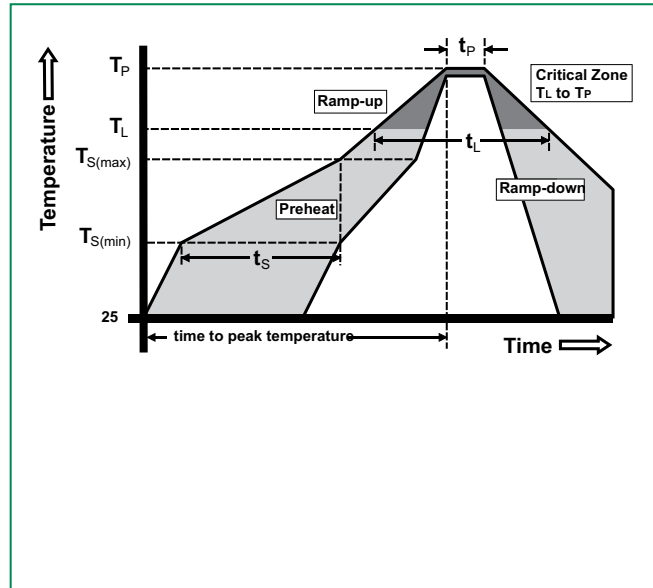

### Product Characteristics

<b>Lead Plating</b>	Pre-Plated Frame
<b>Lead Material</b>	Copper Alloy
<b>Lead Coplanarity</b>	0.0004 inches (0.102mm)
<b>Substrate material</b>	Silicon
<b>Body Material</b>	Molded Epoxy
<b>Flammability</b>	UL 94 V-0

- Notes :
1. All dimensions are in millimeters
  2. Dimensions include solder plating.
  3. Dimensions are exclusive of mold flash & metal burr.
  4. Blo is facing up for mold and facing down for trim/form, i.e. reverse trim/form.
  5. Package surface matte finish VDI 11-13.

### Ordering Information

Part Number	Package	Marking	Min. Order Qty.
SPHV12-01ETG	SOD882	U2	10000
SPHV15-01ETG		U5	
SPHV24-01ETG		U4	
SPHV36-01ETG		U6	
SPHV12-01KTG	SOD882 with side exposed leadframe	U2	10000
SPHV15-01KTG		U5	
SPHV24-01KTG		U4	
SPHV36-01KTG		U6	

### Part Marking System

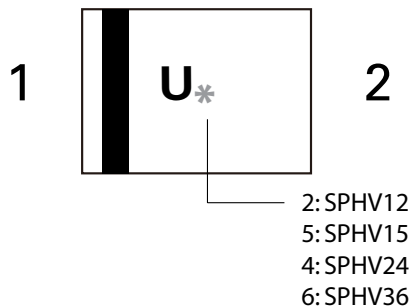

### Part Numbering System

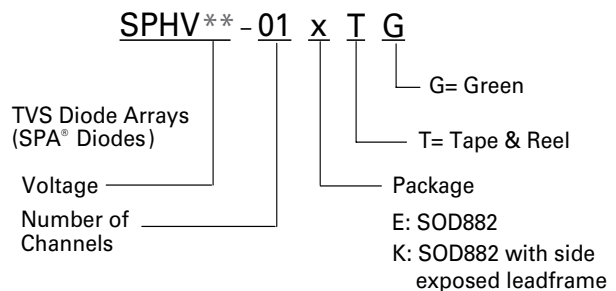

**Package Dimensions — SOD882(SPHVxx-01ETG)**

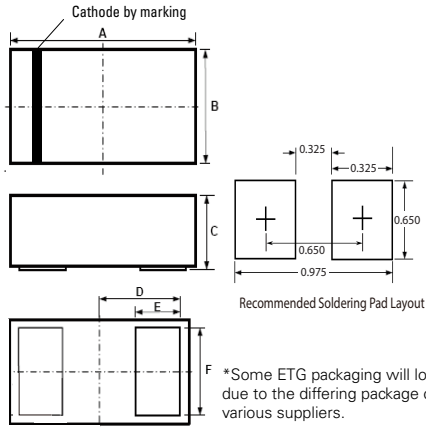

\*Some ETG packaging will look like KTG packaging due to the differing package construction between various suppliers.

Symbol	Package	SOD882				
	JEDEC	MO-236				
	Millimeters			Inches		
	Min	Typ	Max	Min	Typ	Max
<b>A</b>	0.90	1.00	1.10	0.037	0.039	0.041
<b>B</b>	0.50	0.60	0.70	0.022	0.024	0.026
<b>C</b>	0.40	0.50	0.60	0.016	0.020	0.024
<b>D</b>	0.45			0.018		
<b>E</b>	0.20	0.25	0.35	0.008	0.010	0.012
<b>F</b>	0.45	0.50	0.55	0.018	0.020	0.022

**Package Dimensions — SOD882 with side exposed leadframe(SPHVxx-01KTG)**

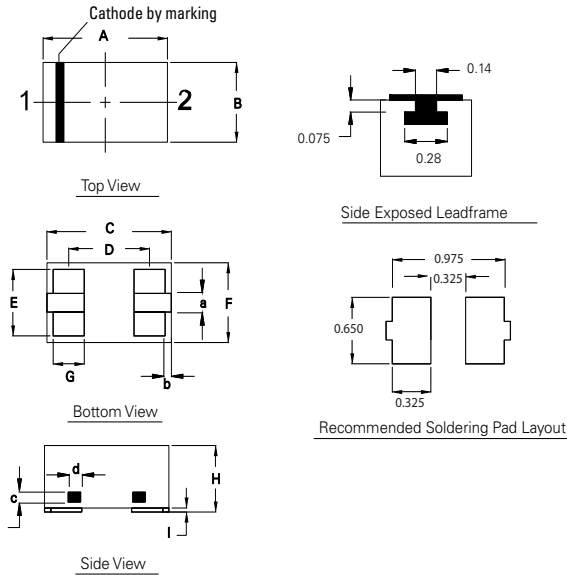

Symbol	Package	SOD882 with side exposed leadframe				
	JEDEC	MO-236				
	Millimeters			Inches		
	Min	Typ	Max	Min	Typ	Max
<b>A</b>	0.90	1.00	1.10	0.037	0.039	0.043
<b>B</b>	0.50	0.60	0.70	0.020	0.024	0.028
<b>C</b>	0.90	1.00	1.10	0.037	0.039	0.043
<b>D</b>	0.55	0.65	0.75	0.022	0.026	0.030
<b>E</b>	0.40	0.50	0.60	0.016	0.020	0.024
<b>F</b>	0.50	0.60	0.70	0.020	0.024	0.028
<b>G</b>	0.20	0.25	0.30	0.008	0.010	0.012
<b>H</b>	0.40	0.50	0.60	0.016	0.020	0.024
<b>I</b>	0.05 max			0.002 max		
<b>a</b>	-	0.14	-	-	0.006	-
<b>b</b>	-	0.04	-	-	0.002	-
<b>c</b>	-	0.075	-	-	0.003	-
<b>d</b>	-	0.10	-	-	0.004	-

**Embossed Carrier Tape & Reel Specification**

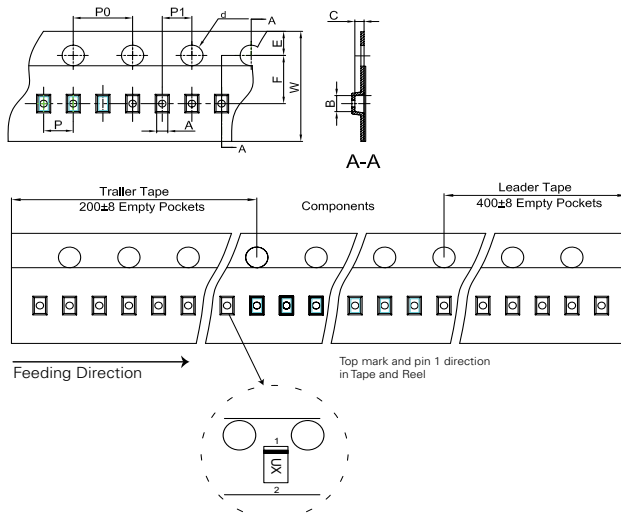

Symbol	Millimeters
<b>A</b>	0.70+/-0.045
<b>B</b>	1.10+/-0.045
<b>C</b>	0.65+/-0.045
<b>d</b>	1.55+/-0.10
<b>E</b>	1.75+/-0.05
<b>F</b>	3.50+/-0.05
<b>P</b>	2.00+/-0.10
<b>P0</b>	4.00+/-0.10
<b>P1</b>	2.00+/-0.10
<b>W</b>	8.00 + 0.30 -0.10