

## P-Channel MOSFET

### 2SJ492-ZJ

#### ■ Features

- $V_{DS} (V) = -60V$
- $I_D = -20 A$
- $R_{DS(ON)} < 100m \Omega$  ( $V_{GS} = -10V$ )
- $R_{DS(ON)} < 185m \Omega$  ( $V_{GS} = -4V$ )
- Low Ciss: Ciss = 1210 pF (TYP.)

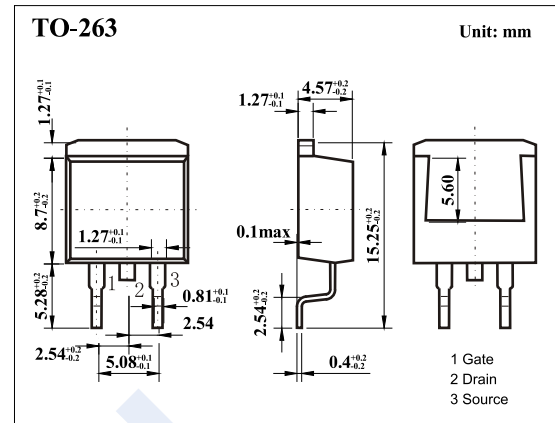
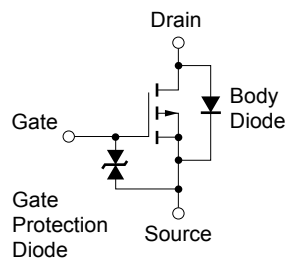

#### ■ Absolute Maximum Ratings $T_a = 25^\circ C$

Parameter	Symbol	Rating	Unit	
Drain-Source Voltage	$V_{DS}$	-60	V	
Gate-Source Voltage (Note.1)	$V_{GS(AC)}$	$\pm 20$		
	$V_{GS(DC)}$	-20,0		
Continuous Drain Current	$I_D$	-20	A	
Pulsed Drain Current (Note.2)	$I_{DM}$	-80		
Single Avalanche Current (Note.3)	$I_{AS}$	-20		
Power Dissipation	$P_D$	$T_c = 25^\circ C$	70	W
		$T_a = 25^\circ C$	1.5	
Single Avalanche Energy (Note.3)	$E_{AS}$	40	mJ	
Thermal Resistance.Junction- to-Ambient	$R_{thJA}$	83.3	$^\circ C/W$	
Thermal Resistance.Junction- to-Case	$R_{thJC}$	1.79		
Junction Temperature	$T_J$	150	$^\circ C$	
Junction Storage Temperature Range	$T_{stg}$	-55 to 150		

Note.1:  $f = 20 \text{ kHz}$ , Duty Cycle  $\leq 10\%$  (+Side)

Note.2:  $PW \leq 10 \mu s$ , Duty Cycle  $\leq 1\%$

Note.3: Starting  $T_J = 25^\circ C$ ,  $R_A = 25 \Omega$ ,  $V_{GS} = -20 V \rightarrow 0$

## P-Channel MOSFET

### 2SJ492-ZJ

#### ■ Electrical Characteristics Ta = 25°C

Parameter	Symbol	Test Conditions	Min	Typ	Max	Unit
Drain-Source Breakdown Voltage	V <sub>DSS</sub>	I <sub>D</sub> =-250 μA, V <sub>GS</sub> =0V	-60			V
Zero Gate Voltage Drain Current	I <sub>DSS</sub>	V <sub>DS</sub> =-60V, V <sub>GS</sub> =0V			-10	μA
Gate-Body leakage current	I <sub>GSS</sub>	V <sub>DS</sub> =0V, V <sub>GS</sub> =±20V			±10	μA
Gate Cut off Voltage	V <sub>GS(off)</sub>	V <sub>DS</sub> =-10V, I <sub>D</sub> =-1mA	-1		-2	V
Static Drain-Source On-Resistance	R <sub>DS(on)</sub>	V <sub>GS</sub> =-10V, I <sub>D</sub> =-10A			100	mΩ
		V <sub>GS</sub> =-4V, I <sub>D</sub> =-10A			185	
Forward Transconductance	g <sub>FS</sub>	V <sub>DS</sub> =-10V, I <sub>D</sub> =-10A	5	12		S
Input Capacitance	C <sub>iss</sub>	V <sub>GS</sub> =0V, V <sub>DS</sub> =-10V, f=1MHz		1210		pF
Output Capacitance	C <sub>oss</sub>			520		
Reverse Transfer Capacitance	C <sub>rss</sub>			180		
Total Gate Charge	Q <sub>g</sub>	V <sub>GS</sub> =-10V, V <sub>DS</sub> =-48V, I <sub>D</sub> =-20A		42		nC
Gate Source Charge	Q <sub>gs</sub>			8		
Gate Drain Charge	Q <sub>gd</sub>			10		
Turn-On DelayTime	t <sub>d(on)</sub>	V <sub>GS(on)</sub> =-10V, V <sub>DS</sub> =-30V, I <sub>D</sub> =-10A, R <sub>G</sub> =10 Ω		16		ns
Turn-On Rise Time	t <sub>r</sub>			140		
Turn-Off DelayTime	t <sub>d(off)</sub>			90		
Turn-Off Fall Time	t <sub>f</sub>			80		
Body Diode Reverse Recovery Time	t <sub>rr</sub>	I <sub>F</sub> =-20A, V <sub>GS</sub> =0, di/dt=50A/μs		125		ns
Body Diode Reverse Recovery Charge	Q <sub>rr</sub>			280		
Diode Forward Voltage	V <sub>SD</sub>	I <sub>F</sub> =-20A, V <sub>GS</sub> =0V		-1		V

#### ■ Typical Characteristics

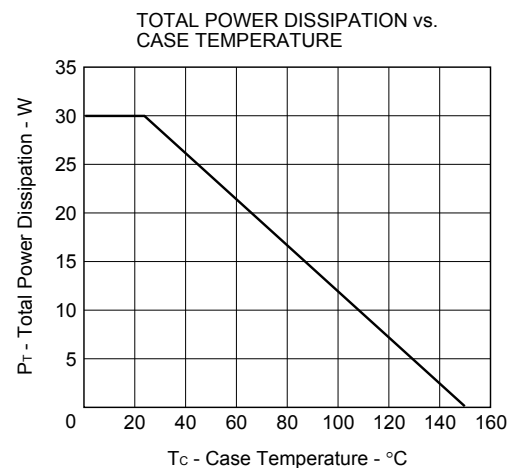
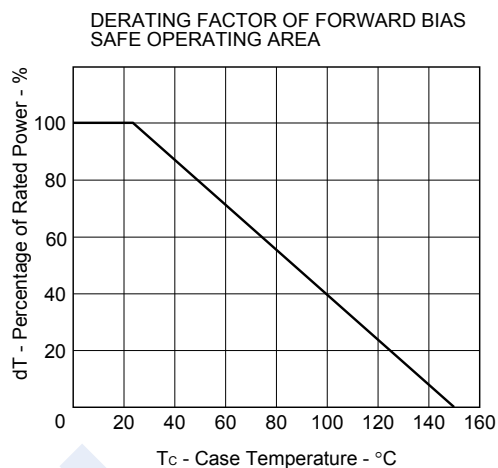

## P-Channel MOSFET 2SJ492-ZJ

■ Typical Characteristics

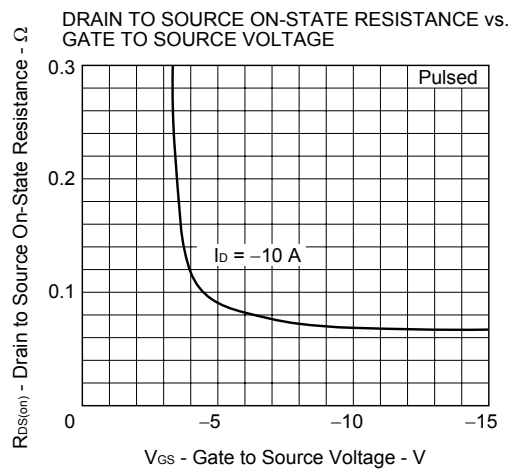
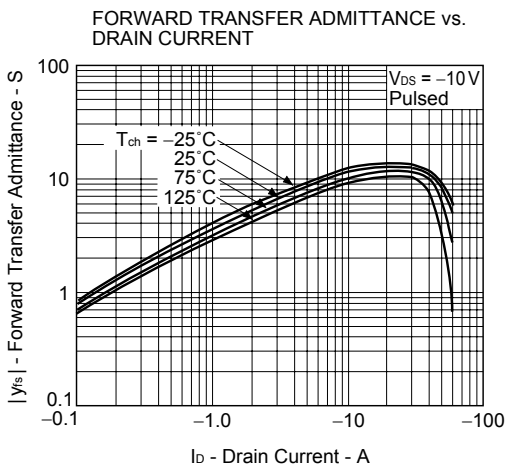
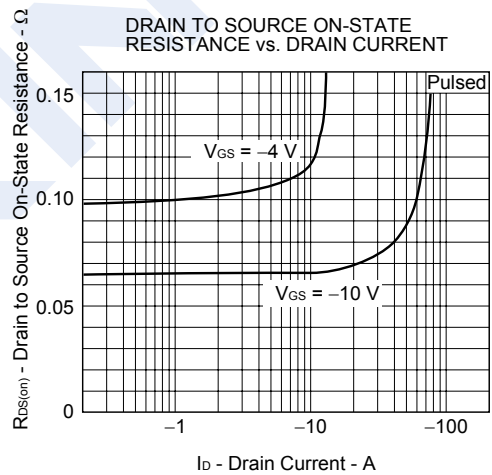
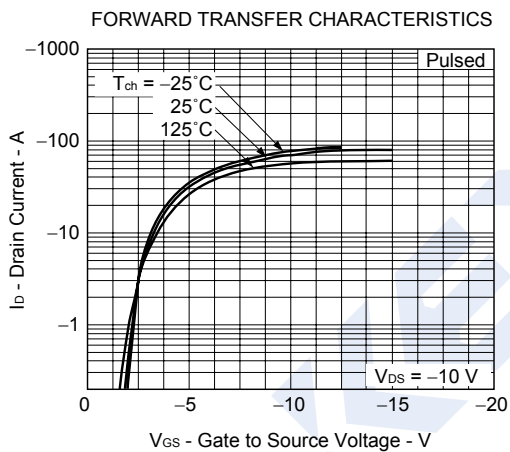
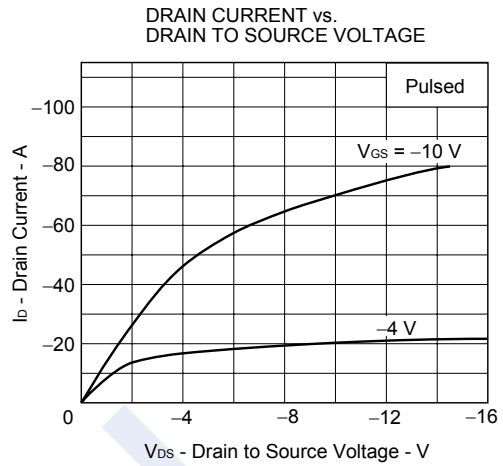
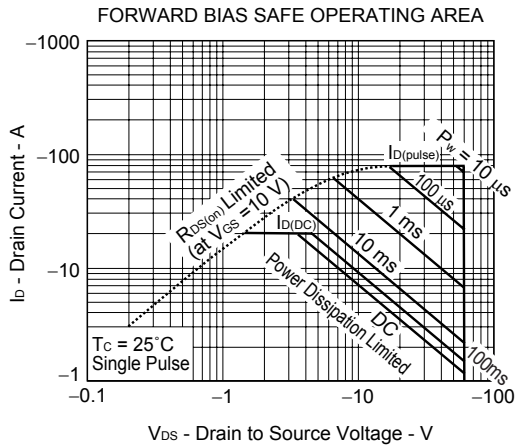

## P-Channel MOSFET 2SJ492-ZJ

■ Typical Characteristics

TRANSIENT THERMAL RESISTANCE vs. PULSE WIDTH

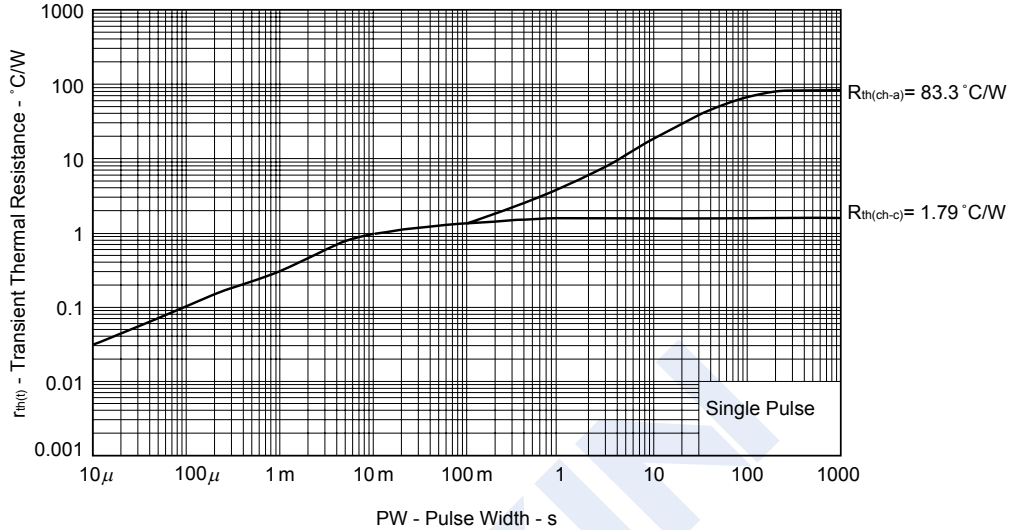

GATE TO SOURCE CUTOFF VOLTAGE vs. CHANNEL TEMPERATURE

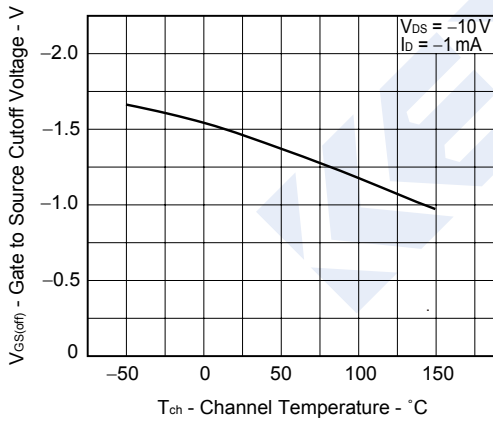

DRAIN TO SOURCE ON-STATE RESISTANCE vs. CHANNEL TEMPERATURE

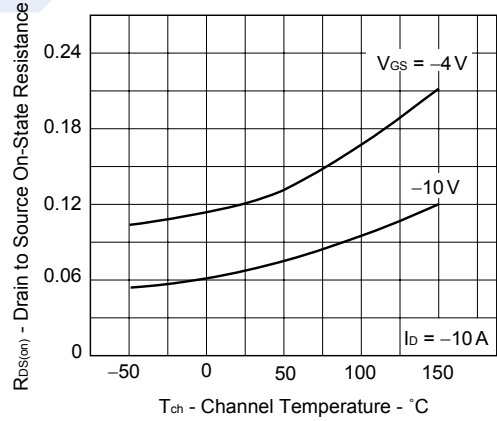

SOURCE TO DRAIN DIODE FORWARD VOLTAGE

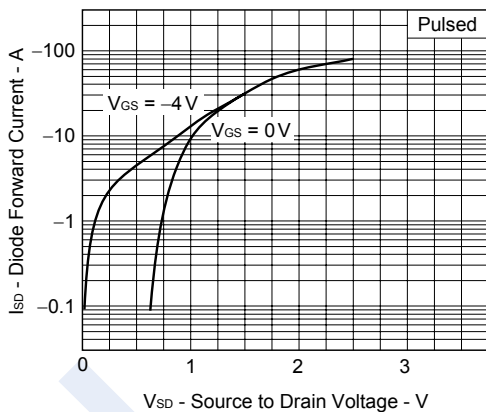

CAPACITANCE vs. DRAIN TO SOURCE VOLTAGE

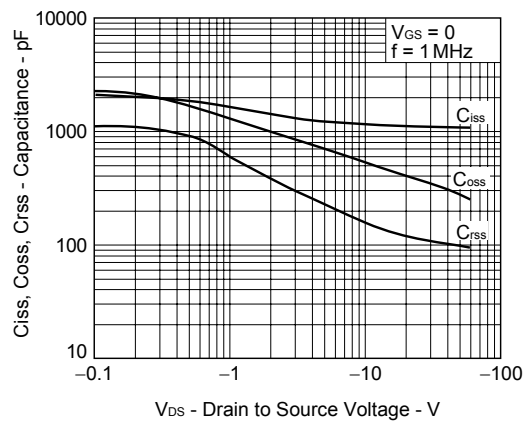

## P-Channel MOSFET 2SJ492-ZJ

### Typical Characteristics

