



**Applications**

- Phase Control
- Static Switching
- Light Dimming
- Motor Speed Control
- Kitchen Equipment
- Power Tools
- Solenoid Valve Controls:
  - Dishwashers
  - Washing Machines

- > Suitable for General Purpose AC Switching
- > IGT 50mA
- > VDRM/VRMM 400, 600, 800V

**CTA30/CTB35**  
400/600/800V - TRIAC

**Absolute Maximum Ratings**

	CONDITIONS	SYMBOL	RATING
RMS On-State Current (full sine wave)	T <sub>c</sub> = 95°C	TO-220AB	IT(RMS) 35A (CTB)
	T <sub>c</sub> = 70°C	TO-220AB Iso	30A (CTA)
Non Repetitive Surge Peak On-State Current (Full Cycle, T <sub>j</sub> Initial = 25°C)	F = 50 Hz	I <sub>TSM</sub>	335A
	F = 60 Hz		350A
I <sup>2</sup> t Value for fusing	tp = 10 ms	I <sup>2</sup> t	500A <sup>2</sup> s
Critical rate of rise of on-state current I <sub>G</sub> = 2 x I <sub>GT</sub> , tr < 100 ns, T <sub>j</sub> = 125°C		di/dt	100A/μsec
Peak Gate Current @ T <sub>j</sub> = 125°C	tp = 20 μs	I <sub>GM</sub>	4A
Average Gate Power Dissipation @ T <sub>j</sub> = 125°C		PG(AV)	1W
Storage Temperature Range		T <sub>stg</sub>	-40 to +150°C
Operating Junction Temperature Range		T <sub>j</sub>	-40 to +125°C
Isolation Voltage (CTA Series only)		V <sub>ISO</sub>	2500 V <sub>RMS</sub>

**Electrical Characteristics**

STANDARD (4 Quadrants)			"B"
I <sub>GT</sub> MAX @ V <sub>D</sub> = 12 V, R <sub>L</sub> = 30Ω	NOTE 1	QI-II-III	50mA
I <sub>GT</sub> MAX @ V <sub>D</sub> = 12 V, R <sub>L</sub> = 30Ω	NOTE 1	QIV	100 mA
V <sub>GT</sub> MAX @ V <sub>D</sub> = 12 V, R <sub>L</sub> = 30Ω		Q-AII	1.3V
V <sub>GD</sub> MIN @ V <sub>D</sub> = V <sub>DRM</sub> , R <sub>L</sub> = 3.3kΩ	T <sub>j</sub> = 125°C	Q-AII	0.2 V
I <sub>H</sub> MAX @ I <sub>T</sub> = 500 mA	NOTE 2		75mA
I <sub>L</sub> MAX @ I <sub>G</sub> = 1.2 I <sub>GT</sub>		QI-III-IV	75mA
I <sub>L</sub> MAX @ I <sub>G</sub> = 1.2 I <sub>GT</sub>		Q-II	100mA
dv/dt MIN @ V <sub>D</sub> = 67%V <sub>DRM</sub> (gate open)	NOTE 2 T <sub>j</sub> = 125°C		500V/μsec
(dv/dt) <sub>c</sub> MIN @ (di/dt) <sub>c</sub> = 13.3 A/ms	NOTE 2 T <sub>j</sub> = 125°C		10V/μsec

**Static Characteristics**

V <sub>T</sub> MAX @ I <sub>TM</sub> = 48 A, tp = 380μs	NOTE 2 T <sub>j</sub> = 25°C	1.55 V
V <sub>to</sub> MAX @ Threshold Voltage	NOTE 2 T <sub>j</sub> = 125°C	0.85 V
R <sub>d</sub> MAX @ Dynamic Resistance	NOTE 2 T <sub>j</sub> = 125°C	16 mΩ
I <sub>DRM</sub> MAX @ V <sub>DRM</sub> = V <sub>RRM</sub>	T <sub>j</sub> = 25°C	5μA
I <sub>RRM</sub> MAX @ V <sub>DRM</sub> = V <sub>RRM</sub>	T <sub>j</sub> = 125°C	3 mA

**GENERAL NOTES**

1. Minimum IGT is guaranteed at 5% of IGT max.
2. For both polarities of A2 referenced to A1
3. All parameters at 25 degrees C unless otherwise specified.

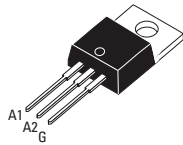

TO-220AB Isolated (CTA30)

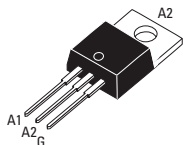

TO-220AB Non-Isolated (CTB35)



### Thermal Resistances

	SYMBOL	RATING
Junction to Case (AC)	TO-220AB	$R_{th(j-c)}$ 0.8°C/W
Junction to Case (AC)	TO-220AB Isolated	$R_{th(j-c)}$ 1.7°C/W
Junction to Ambient	TO-220AB	$R_{th(j-a)}$ 60°C/W
Junction to Ambient	TO-220AB Isolated	$R_{th(j-a)}$ 60°C/W

### Part Number Selection

Part Number	Voltage [Vpk]	$I_{GT}$ [mA]	Type	Package
CTA30-xxxB	400, 600, 800	50mA	Standard	TO-220AB
CTB35-xxxB	400, 600, 800	50mA	Standard	TO-220AB

### Part Number Designation

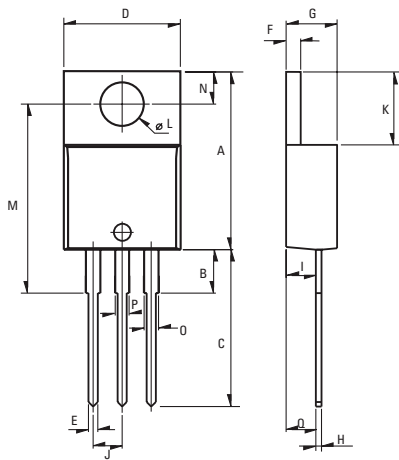
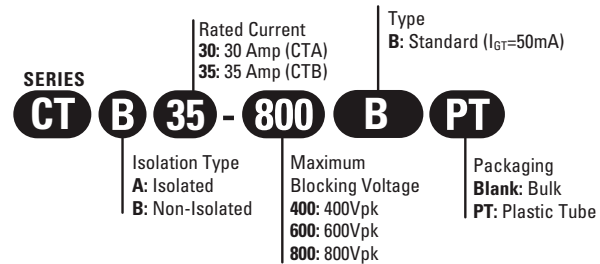

Weight: 2.3g (0.08 oz)

### Dimensions

REF.	Millimeters			Inches		
	Min.	Typ.	Max.	Min.	Typ.	Max.
A	15.24		15.75	0.6		0.62
B		3.23			0.127	
C	12.78		13.79	0.503		0.543
D	9.96		10.36	0.392		0.408
E	0.69		0.94	0.027		0.037
F	1.22		1.32	0.048		0.052
G	4.62		4.83	0.182		0.19
H	0.46		0.61	0.018		0.024
I	2.49		2.84	0.098		0.112
J	2.39		2.69	0.094		0.106
K	6.48		6.88	0.255		0.271
L	3.78		3.89	0.149		0.153
M	15.49	16	16.51	0.61	0.63	0.65
N	2.59		2.9	0.102		0.114
O	0.99		1.55	0.039		0.061
P	0.99		1.55	0.039		0.061
Q		2.67			0.105	

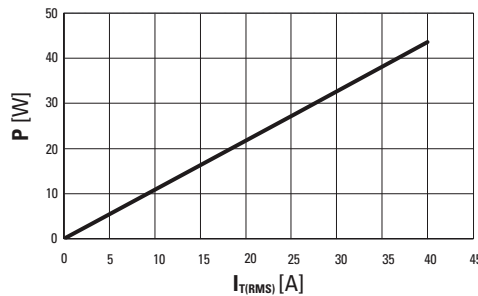

Fig. 1: Power dissipation versus RMS on-state current (full cycle).

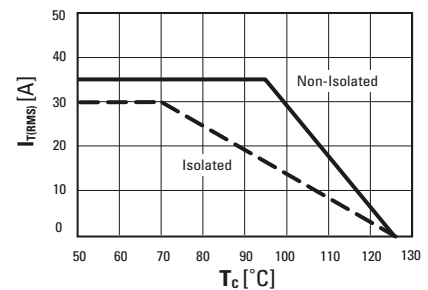

Fig. 2: RMS on-state current versus case temperature (full cycle)

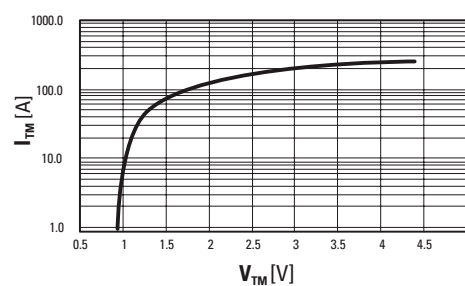

Fig. 3: On-state current versus on-state voltage (instantaneous values)

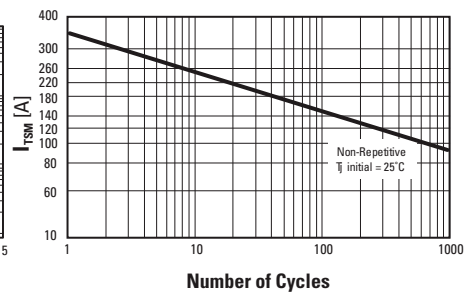

Fig. 4: Non-repetitive surge peak on-state current versus number of cycles.

### ISO9001 Certified

### Approvals

UL Recognized Component - E72445  
(For CTA series)

#### USA

Sales Support (866) 258-5057  
 Tech Support (866) 258-5057  
 Fax (619) 690-7432  
 Email: sales@cynergy3.com  
 Cynergy3 Components  
 2320 Paseo de las Americas, Suite 104  
 San Diego, CA 92154

#### EUROPE - UK

Telephone +44 (0) 1202 897969  
 Fax +44 (0) 1202 891918  
 Email: sales@cynergy3.com  
 Cynergy3 Components Ltd.  
 7 Cobham Road  
 Ferndown Industrial Estate  
 Wimborne, Dorset BH21 7PE

#### ASIA - Thailand

Telephone +66 (0)2 665 2517  
 Fax +66 (0)2 665 2588  
 Cynergy3 Components Asia  
 18/8 Fico Place 12th Floor  
 Soi Sukhumvit 21 (Asoke)  
 Klongtoey Nua, Wattana  
 Bangkok, Thailand 10110