



### Höchstzulässige Werte / maximum rated values

#### Elektrische Eigenschaften / electrical properties

Kollektor Emitter Sperrspannung collector emitter voltage	$T_{vj} = 25^{\circ}\text{C}$	$V_{CES}$	1200	V
Kollektor Dauergleichstrom DC collector current	$T_c = 80^{\circ}\text{C}$ $T_c = 25^{\circ}\text{C}$	$I_{C, nom}$ $I_C$	200 295	A A
Periodischer Kollektor Spitzenstrom repetitive peak collector current	$t_p = 1\text{ms}, T_c = 80^{\circ}\text{C}$	$I_{CRM}$	400	A
Gesamt Verlustleistung total power dissipation	$T_c = 25^{\circ}\text{C}, \text{Transistor}$	$P_{tot}$	1040	W
Gate Emitter Spitzenspannung gate emitter peak voltage		$V_{GES}$	+/- 20	V
Dauergleichstrom DC forward current		$I_F$	200	A
Periodischer Spitzenstrom repetitive peak forward current	$t_p = 1\text{ms}$	$I_{FRM}$	400	A
Grenzlastintegral $I^2t$ value	$V_R = 0\text{V}, t_p = 10\text{ms}, T_{vj} = 125^{\circ}\text{C}$	$I^2t$	7,8	$\text{k A}^2\text{s}$
Isolations Prüfspannung insulation test voltage	RMS, $f = 50\text{Hz}, t = 1\text{min.}$	$V_{ISOL}$	2,5	kV

### Charakteristische Werte / characteristic values

#### Transistor Wechselrichter / transistor inverter

			min.	typ.	max.	
Kollektor Emitter Sättigungsspannung collector emitter saturation voltage	$I_C = 200\text{A}, V_{GE} = 15\text{V}, T_{vj} = 25^{\circ}\text{C}$ $I_C = 200\text{A}, V_{GE} = 15\text{V}, T_{vj} = 125^{\circ}\text{C}$	$V_{CESat}$	-	1,7 2,0	2,15 -	V V
Gate Schwellenspannung gate threshold voltage	$I_C = 8\text{mA}, V_{CE} = V_{GE}, T_{vj} = 25^{\circ}\text{C}$	$V_{GE(th)}$	5,0	5,8	6,5	V
Gateladung gate charge	$V_{GE} = -15\text{V} \dots +15\text{V}$	$Q_G$	-	1,9	-	$\mu\text{C}$
Eingangskapazität input capacitance	$f = 1\text{MHz}, T_{vj} = 25^{\circ}\text{C}, V_{CE} = 25\text{V}, V_{GE} = 0\text{V}$	$C_{ies}$	-	14	-	nF
Rückwirkungskapazität reverse transfer capacitance	$f = 1\text{MHz}, T_{vj} = 25^{\circ}\text{C}, V_{CE} = 25\text{V}, V_{GE} = 0\text{V}$	$C_{res}$	-	0,5	-	nF
Kollektor Emitter Reststrom collector emitter cut off current	$V_{GE} = 0\text{V}, T_{vj} = 25^{\circ}\text{C}, V_{CE} = 600\text{V}$	$I_{CES}$	-	-	5	mA
Gate Emitter Reststrom gate emitter leakage current	$V_{CE} = 0\text{V}, V_{GE} = 20\text{V}, T_{vj} = 25^{\circ}\text{C}$	$I_{GES}$	-	-	400	nA

prepared by: MOD-D2; Mark Münzer

date of publication: 2002-10-02

approved: SM TM; Wilhelm Rusche

revision: 3.0



### Charakteristische Werte / characteristic values

#### Transistor Wechselrichter / transistor inverter

			min.	typ.	max.	
Einschaltverzögerungszeit (induktive Last) turn on delay time (inductive load)	$I_C = 200A, V_{CC} = 600V$ $V_{GE} = \pm 15V, R_G = 3,6\Omega, T_{vj} = 25^\circ C$	$t_{d,on}$	-	0,25	-	$\mu s$
	$V_{GE} = \pm 15V, R_G = 3,6\Omega, T_{vj} = 125^\circ C$		-	0,30	-	$\mu s$
Anstiegszeit (induktive Last) rise time (inductive load)	$I_C = 200A, V_{CC} = 600V$ $V_{GE} = \pm 15V, R_G = 3,6\Omega, T_{vj} = 25^\circ C$	$t_r$	-	0,09	-	$\mu s$
	$V_{GE} = \pm 15V, R_G = 3,6\Omega, T_{vj} = 125^\circ C$		-	0,10	-	$\mu s$
Abschaltverzögerungszeit (induktive Last) turn off delay time (inductive load)	$I_C = 200A, V_{CC} = 600V$ $V_{GE} = \pm 15V, R_G = 3,6\Omega, T_{vj} = 25^\circ C$	$t_{d,off}$	-	0,55	-	$\mu s$
	$V_{GE} = \pm 15V, R_G = 3,6\Omega, T_{vj} = 125^\circ C$		-	0,65	-	$\mu s$
Fallzeit (induktive Last) fall time (inductive load)	$I_C = 200A, V_{CC} = 600V$ $V_{GE} = \pm 15V, R_G = 3,6\Omega, T_{vj} = 25^\circ C$	$t_f$	-	0,13	-	$\mu s$
	$V_{GE} = \pm 15V, R_G = 3,6\Omega, T_{vj} = 125^\circ C$		-	0,18	-	$\mu s$
Einschaltverlustenergie pro Puls turn on energy loss per pulse	$I_C = 200A, V_{CC} = 600V, L_\sigma = 80nH$ $V_{GE} = \pm 15V, R_G = 3,6\Omega, T_{vj} = 125^\circ C$	$E_{on}$	-	15	-	mJ
Ausschaltverlustenergie pro Puls turn off energy loss per pulse	$I_C = 200A, V_{CC} = 600V, L_\sigma = 80nH$ $V_{GE} = \pm 15V, R_G = 3,6\Omega, T_{vj} = 125^\circ C$	$E_{off}$	-	35	-	mJ
Kurzschlussverhalten SC data	$t_p \leq 10\mu s, V_{GE} \leq 15V, T_{vj} \leq 125^\circ C$ $V_{CC} = 900V, V_{CEmax} = V_{CES} - L_{\sigma CE} \cdot di/dt$	$I_{SC}$	-	800	-	A
Modulinduktivität stray inductance module		$L_{\sigma CE}$	-	20	-	nH
Leitungswiderstand, Anschluss-Chip lead resistance, terminal-chip	$T_c = 25^\circ C$	$R_{CC/EE}$	-	0,7	-	m $\Omega$

### Charakteristische Werte / characteristic values

#### Inversdiode / free-wheel diode

Durchlassspannung forward voltage	$I_F = 200A, V_{GE} = 0V, T_{vj} = 25^\circ C$	$V_F$	-	1,65	2,15	V
	$I_F = 200A, V_{GE} = 0V, T_{vj} = 125^\circ C$		-	1,65	-	V
Rückstromspitze peak reverse recovery current	$I_F = 200A, -di_F/dt = 2000A/\mu s$ $V_R = 600V, V_{GE} = -15V, T_{vj} = 25^\circ C$	$I_{RM}$	-	150	-	A
	$V_R = 600V, V_{GE} = -15V, T_{vj} = 125^\circ C$		-	190	-	A
Sperrverzögerungsladung recovered charge	$I_F = 200A, -di_F/dt = 2000A/\mu s$ $V_R = 600V, V_{GE} = -15V, T_{vj} = 25^\circ C$	$Q_r$	-	20	-	$\mu C$
	$V_R = 600V, V_{GE} = -15V, T_{vj} = 125^\circ C$		-	36	-	$\mu C$
Ausschaltenergie pro Puls reverse recovery energy	$I_F = 200A, -di_F/dt = 2000A/\mu s$ $V_R = 600V, V_{GE} = -15V, T_{vj} = 25^\circ C$	$E_{rec}$	-	9	-	mJ
	$V_R = 600V, V_{GE} = -15V, T_{vj} = 125^\circ C$		-	17	-	mJ



### Charakteristische Werte / characteristic values

#### Chopperdiode / chopper diode

Durchlassspannung forward voltage	$I_F = 300A, V_{GE} = 0V, T_{vj} = 25^\circ C$	$V_F$	-	1,65	2,15	V
	$I_F = 300A, V_{GE} = 0V, T_{vj} = 125^\circ C$		-	1,65	-	V
Rückstromspitze peak reverse recovery current	$I_F = 300A, -di_F/dt = 3000A/\mu s$	$I_{RM}$	-	210	-	A
	$V_R = 600V, V_{GE} = -15V, T_{vj} = 25^\circ C$ $V_R = 600V, V_{GE} = -15V, T_{vj} = 125^\circ C$		-	270	-	A
Sperrverzögerungsladung recovered charge	$I_F = 300A, -di_F/dt = 3000A/\mu s$	$Q_r$	-	30	-	$\mu C$
	$V_R = 600V, V_{GE} = -15V, T_{vj} = 25^\circ C$ $V_R = 600V, V_{GE} = -15V, T_{vj} = 125^\circ C$		-	56	-	$\mu C$
Ausschaltenergie pro Puls reverse recovery energy	$I_F = 300A, -di_F/dt = 3000A/\mu s$	$E_{rec}$	-	14	-	mJ
	$V_R = 600V, V_{GE} = -15V, T_{vj} = 25^\circ C$ $V_R = 600V, V_{GE} = -15V, T_{vj} = 125^\circ C$		-	26	-	mJ

### Thermische Eigenschaften / thermal properties

Innerer Wärmewiderstand; DC thermal resistance, junction to case; DC	Transistor Wecheln. / transistor inverter	$R_{thJC}$	-	-	0,12	K/W
	Inversdiode / free wheel diode		-	-	0,20	K/W
	Chopper Diode / chopper diode		-	-	0,15	K/W
Übergangs Wärmewiderstand thermal resistance, case to heatsink	pro Modul / per module $\lambda_{Paste} = 1W/m^*K / \lambda_{grease} = 1W/m^*K$	$R_{thCK}$	-	0,01	-	K/W
Höchstzulässige Sperrschichttemp. maximum junction temperature		$T_{vj\ max}$	-	-	150	$^\circ C$
Betriebstemperatur operation temperature		$T_{vj\ op}$	-40	-	125	$^\circ C$
Lagertemperatur storage temperature		$T_{stg}$	-40	-	125	$^\circ C$

### Mechanische Eigenschaften / mechanical properties

Gehäuse, siehe Anlage case, see appendix						
Innere Isolation internal insulation				$Al_2O_3$		
CTI comperative tracking index				425		
Anzugsdrehmoment, mech. Befestigung mounting torque	Schraube M6 / screw M6	M	3,0	-	6,0	Nm
Anzugsdrehmoment, elektr. Anschlüsse terminal connection torque	Anschlüsse / terminals M6	M	2,5	-	5,0	Nm
Gewicht weight		G		340		g

Mit dieser technischen Information werden Halbleiterbauelemente spezifiziert, jedoch keine Eigenschaften zugesichert. Sie gilt in Verbindung mit den zugehörigen technischen Erläuterungen.

This technical information specifies semiconductor devices but promises no characteristics. It is valid with the belonging technical notes.



**Ausgangskennlinie (typisch)**  
**output characteristic (typical)**

$I_C = f(V_{CE})$   
 $V_{GE} = 15V$

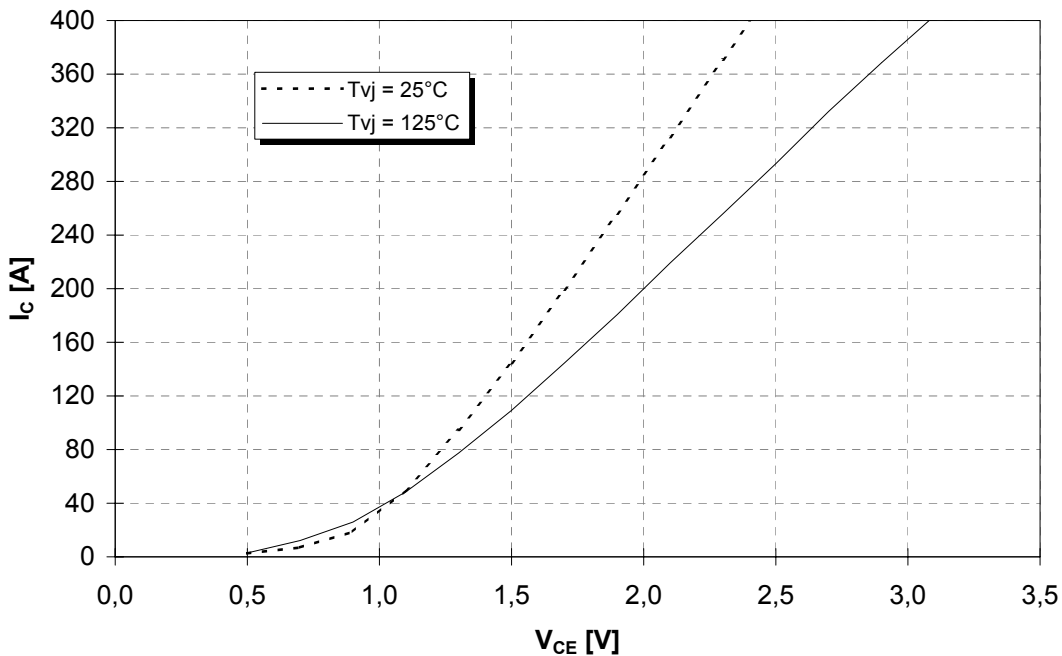

**Ausgangskennlinienfeld (typisch)**  
**output characteristic (typical)**

$I_C = f(V_{CE})$   
 $T_{vj} = 125^\circ C$

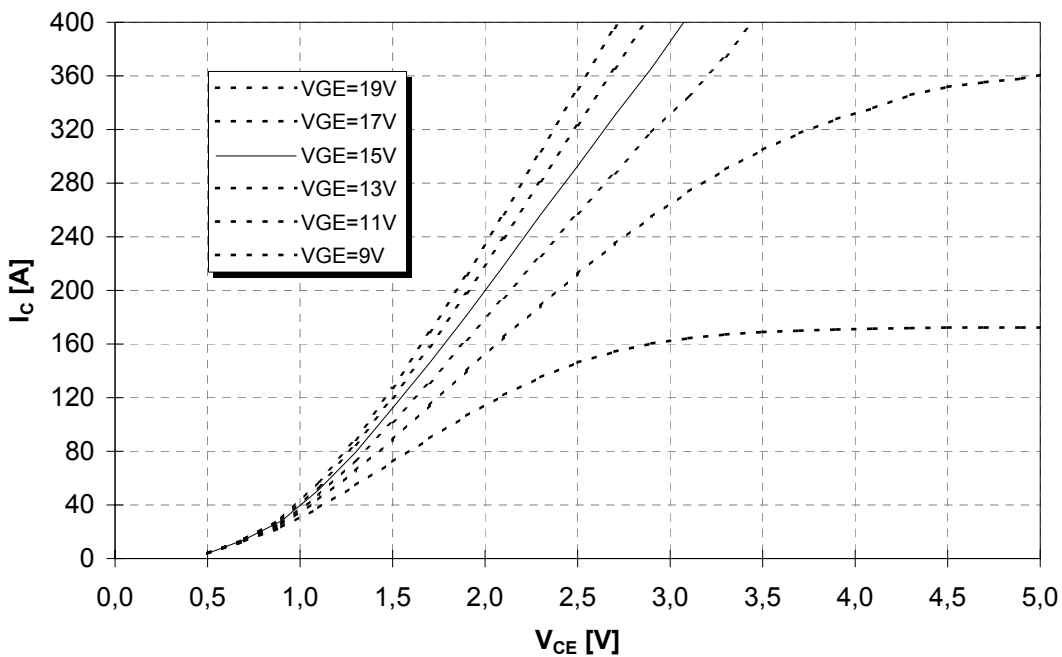



Übertragungscharakteristik (typisch)  
transfer characteristic (typical)

$I_C = f(V_{GE})$   
 $V_{CE} = 20V$

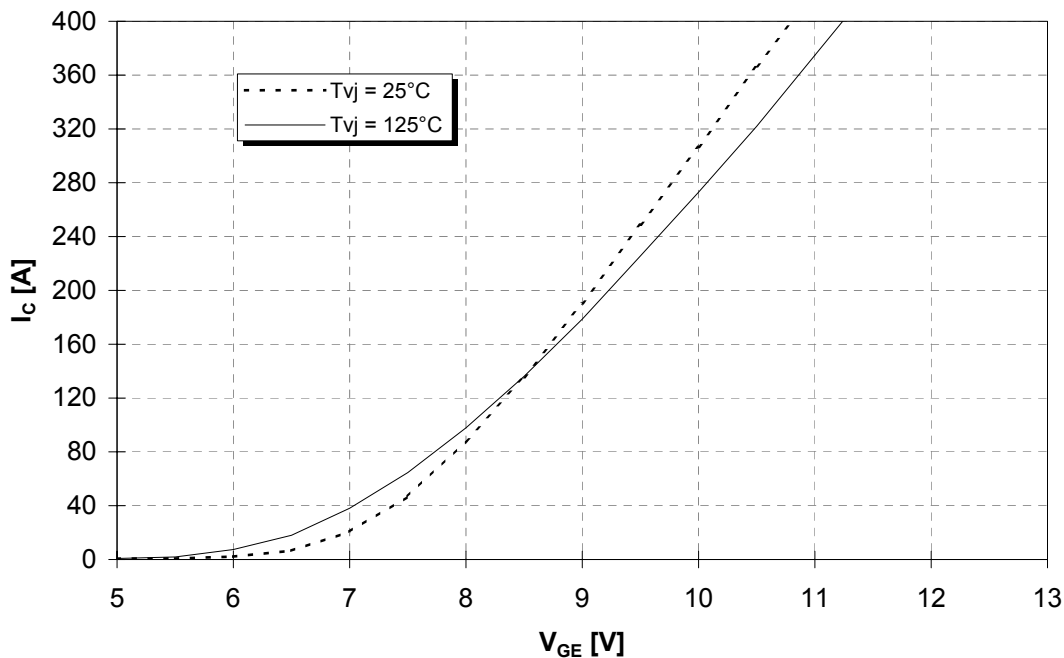

Durchlasskennlinie der Inversdiode (typisch)  
forward characteristic of inverse diode (typical)

$I_F = f(V_F)$

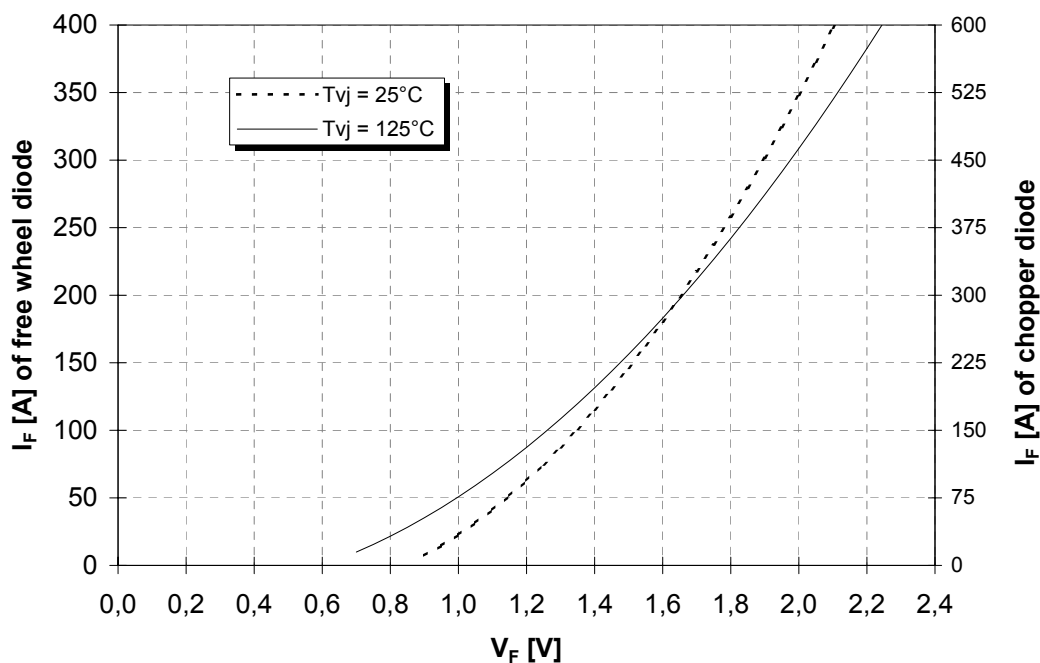



Schaltverluste (typisch)  
Switching losses (typical)

$E_{on} = f(I_C)$ ,  $E_{off} = f(I_C)$ ,  $E_{rec} = f(I_C)$   
 $V_{GE} = \pm 15V$ ,  $R_G = 3,6\Omega$ ,  $V_{CE} = 600V$ ,  $T_{vj} = 125^\circ C$

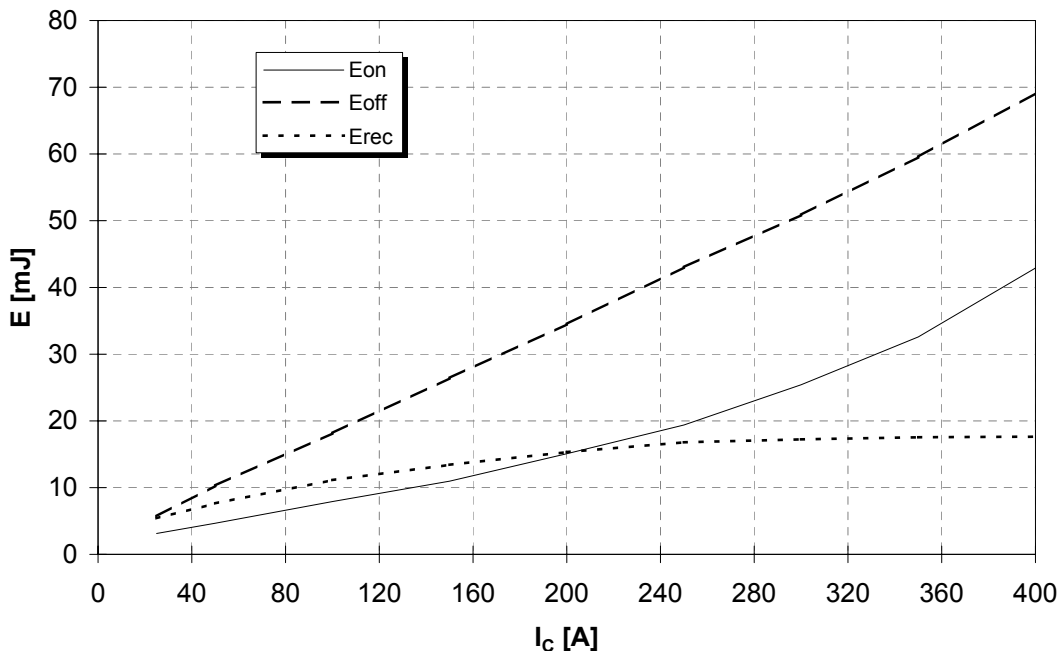

Schaltverluste (typisch)  
Switching losses (typical)

$E_{on} = f(R_G)$ ,  $E_{off} = f(R_G)$ ,  $E_{rec} = f(R_G)$   
 $V_{GE} = \pm 15V$ ,  $I_C = 200A$ ,  $V_{CE} = 600V$ ,  $T_{vj} = 125^\circ C$

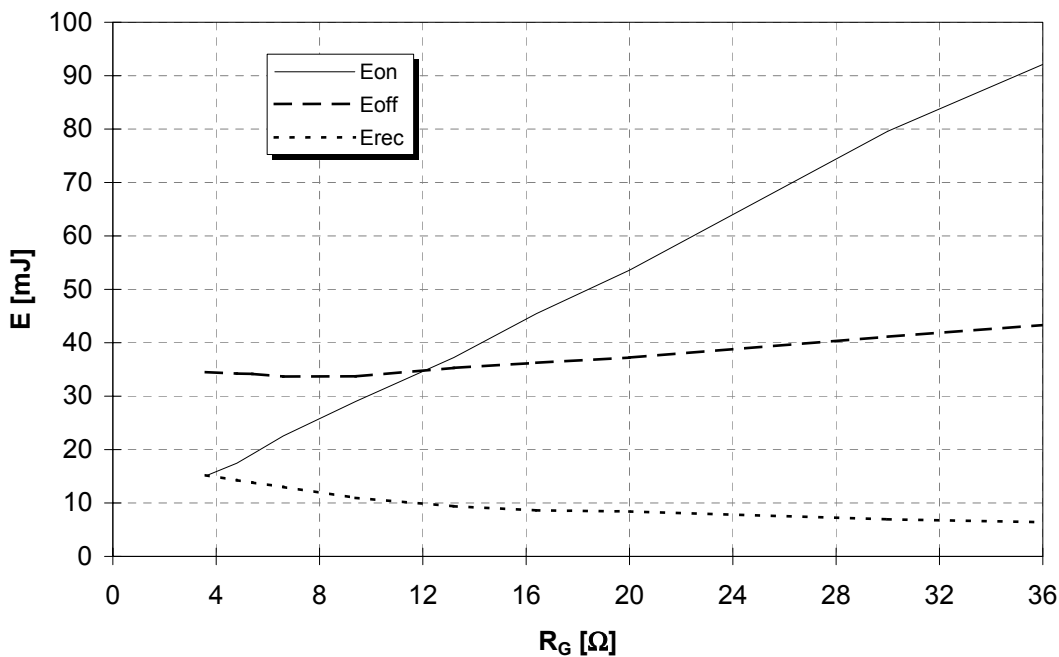



Transienter Wärmewiderstand  
Transient thermal impedance

$$Z_{thJC} = f(t)$$

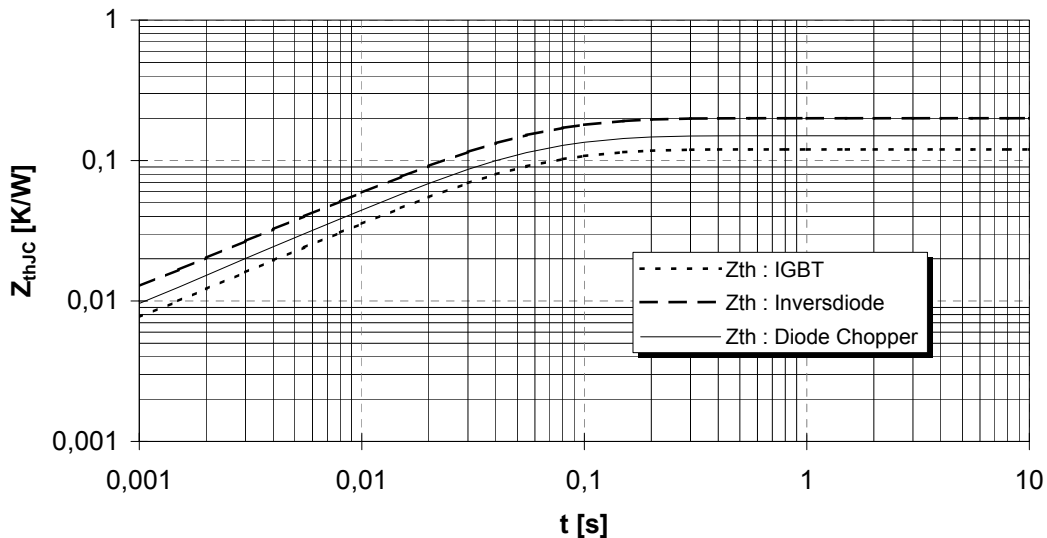

i	1	2	3	4
$r_i$ [K/kW] : IGBT	50,44	60,45	6,83	2,28
$\tau_i$ [s] : IGBT	6,499E-02	2,601E-02	2,364E-03	1,187E-05
$r_i$ [K/kW] : Inversdiode	83,98	100,88	11,36	3,78
$\tau_i$ [s] : Inversdiode	6,499E-02	2,601E-02	2,364E-03	1,187E-05
$r_i$ [K/kW] : Chopper Diode	63,07	75,68	8,53	2,84
$\tau_i$ [s] : Chopper Diode	6,499E-02	2,601E-02	2,364E-03	1,187E-05

Sicherer Arbeitsbereich (RBSOA)  
Reverse bias safe operation area (RBSOA)

$$V_{GE} = \pm 15V, T_{vj} = 125^\circ C, R_G = 3,6\Omega$$

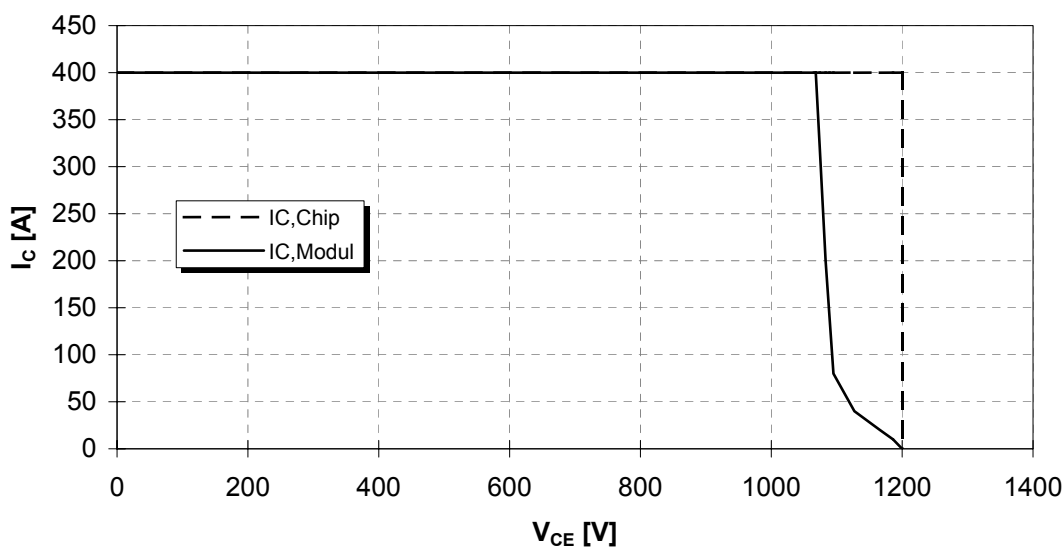

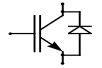

### Gehäusemaße / Schaltbild Package outline / Circuit diagram

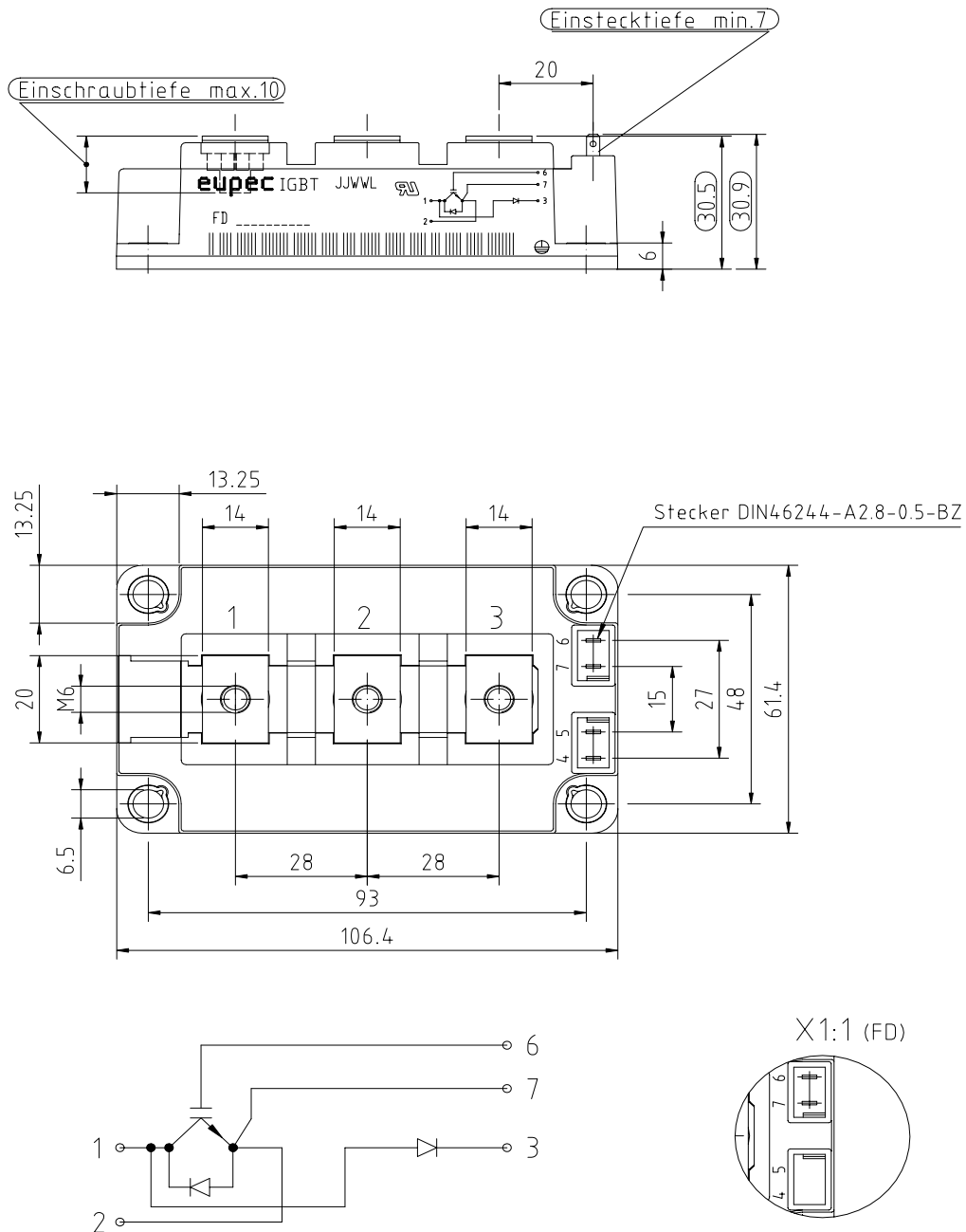

Kriechstrecke creepage distance			20	mm
Luftstrecke clearance distance			11	mm



## **Terms & Conditions of Usage**

### **Attention**

The present product data is exclusively subscribed to technically experienced staff. This Data Sheet is describing the specification of the products for which a warranty is granted exclusively pursuant the terms and conditions of the supply agreement. There will be no guarantee of any kind for the product and its specifications. Changes to the Data Sheet are reserved.

You and your technical departments will have to evaluate the suitability of the product for the intended application and the completeness of the product data with respect to such application. Should you require product information in excess of the data given in the Data Sheet, please contact your local Sales Office via "[www.eupec.com](http://www.eupec.com) / sales & contact".

### **Warning**

Due to technical requirements the products may contain dangerous substances. For information on the types in question please contact your local Sales Office via "[www.eupec.com](http://www.eupec.com) / sales & contact".