

ENGINEERING DATA SHEET

SERIES X

*RELAY - NONLATCH
2 PDT, LOW LEVEL TO 5 AMP*

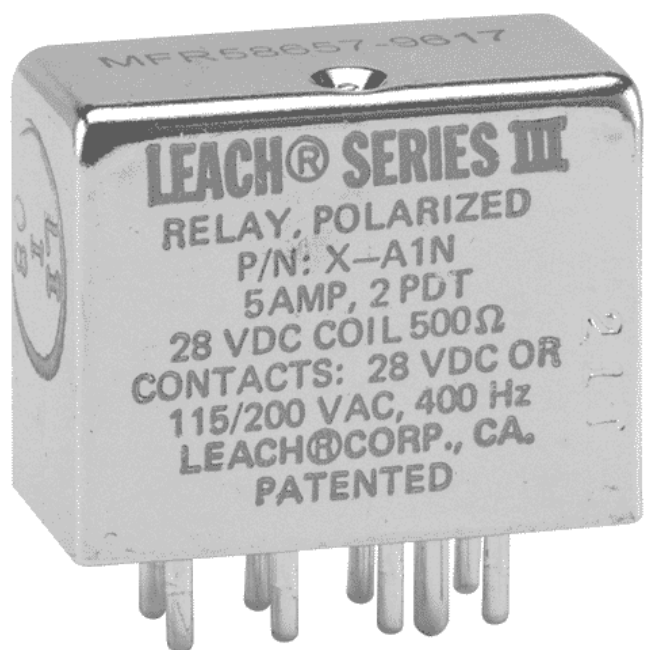

APPLICATION NOTES:

- [101](#)
- [102](#)
- [103A](#)
- [007](#)
- [023](#)

APPLICABLE SOCKETS:

- [SO-1064-001](#)
- [SM-1000-003](#)

Contact arrangement **2 PDT**
 Qualified to **MIL-PRF-6106**

PRINCIPLE TECHNICAL CHARACTERISTICS

Contacts rated at **Low level, 28 Vdc and 115/200 Vac,
400Hz 3Ø, case grounded**

Weight **0.034lb max**

Dimensions **.41in x .81in x .64in**

Special models available upon request.

Hermetically sealed, corrosion resistant metal can.

CONTACT ELECTRICAL CHARACTERISTICS

Contact rating per pole and load type [1]	Load current in Amps		
	@28 Vdc	@115 Vac, 400 Hz, 1Ø	@115/200 Vac, 400 Hz, 3Ø
Resistive	5	5	5
Inductive [2]	3	5	5
Motor	2	3	3
Lamp	1	1	-
Overload	20	30	30
Rupture	25	40	40
Low level [3]	-	-	-
Time current characteristics [4]	-	-	-



Featuring **LEACH®** power and control solutions
www.esterline.com

AMERICAS
 6900 Orangethorpe Ave.
 P.O. Box 5032
 Buena Park, CA 90622

Tel: (01) 714-736-7599
 Fax: (01) 714-670-1145

EUROPE
 2 Rue Goethe
 57430 Sarralbe
 France

Tel: (33) 3 87 97 31 01
 Fax: (33) 3 87 97 96 86

ASIA
 Units 602-603 6/F Lakeside 1
 No.8 Science Park West Avenue
 Phase Two, Hong Kong Science Park
 Pak Shek Kok, Tai Po, N.T.
 Hong Kong
 Tel: (852) 2 191 3830
 Fax: (852) 2 389 5803

Data sheets are for initial product selection and comparison. Contact Esterline Power Systems prior to choosing a component.

COIL CHARACTERISTICS (Vdc)**SERIES X**

CODE	A	B	C	M	N [5]	R [5]	V [5]
Nominal operating voltage	28	12	6	48	28	12	6
Maximum operating voltage	29	14.5	7.3	50	29	14.5	7.3
Maximum pickup voltage							
- Cold coil at +125° C	18	9	4.5	36	18	9	4.5
- During high temp test at +125° C	19.8	9.9	5	38	19.8	9.9	5
- During continuous current test at +125° C	22.5	11.25	5.7	42	22.5	11.25	5.7
Maximum drop-out voltage	7	4.5	2.5	14	7	7	2.5
Coil resistance in Ω $\pm 10\%$ at +25° C, except types "C" and "V" +20%, -10% $\pm 20\%$	500	125	20	1600	500	125	20

GENERAL CHARACTERISTICS

Temperature range	-70°C to +125°C
Minimum operating cycles (life) at rated load	100,000
Minimum operating cycles (life) at 25% rated load	400,000
Dielectric strength at sea level	
- All circuits to ground and circuit to circuit	1000 Vrms
- Coil to ground	1000 Vrms
Dielectric strength at altitude 80,000 ft	500 Vrms [6]
Insulation resistance	
- Initial (500 Vdc)	100 M Ω min
- After environmental tests (500 Vdc)	50 M Ω min
Sinusoidal vibration (A, D and J mounting)	0.12DA / 10 to 70 Hz 30G / 70 to 3000 Hz
Sinusoidal vibration (E mounting in track)	0.06DA / 10 to 57 Hz 10G / 57 to 500 Hz 20G / 500 to 3000 Hz
Sinusoidal vibration (G mounting)	0.12DA / 10 to 57 Hz 20G / 57 to 3000 Hz
Random vibration	
- Applicable specification	MIL-STD-202
- Method	214
- Test condition - A, D and J mounting	1G (0.4g ² /Hz, 50 to 2000 Hz)
- Test condition - E and G mounting (E in track)	1E (0.2G ² /Hz, 50 to 2000 Hz)
- Duration	15 minutes each plane
Shock (A, D and J mounting)	200G / 6 ms
Shock (E mounting in track)	50G / 11 ms
Shock (G mounting)	100G / 6 ms
Maximum contact opening time under vibration and shock	10 μ s
Operate time at nominal voltage@25°C	4 ms max
Release time at nominal voltage@25°C	4 ms max
Contact make bounce at nominal voltage@25°C	0.5 ms max
Contact release break bounce at nominal voltage@25°C	0.1 ms max [7]
Weight maximum	0.034lb

Unless otherwise noted, the specified temperature range applies to all relay characteristics.

- [1] Standard Intermediate current test applicable.
- [2] Inductive load life, 20,000 cycles.
- [3] Low level endurance test: contact load of 10 to 50 millivolt, 10 to 50 microamp, 100 Ohm max. contact resistance.
- [4] Refer to MIL-R-83536 for details.
- [5] "N" "R" & "V" coils have back EMF suppression to 42 volts maximum.
- [6] 500 Vrms with silicone rubber gasket compressed, 250 Vrms all other conditions.
- [7] Applicable to Type "N", "R" & "V" coils only.
- 8. Reference M83536/1,2,3,4.
- 9. Relay will not operate, but will not be damaged by application of reverse polarity on coil.

NUMBERING SYSTEM

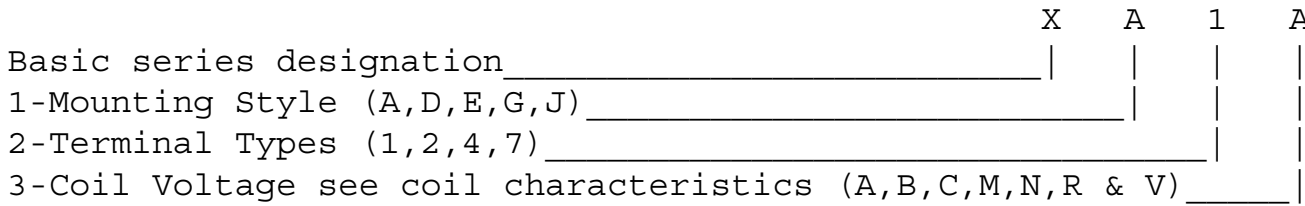

MOUNTING STYLES

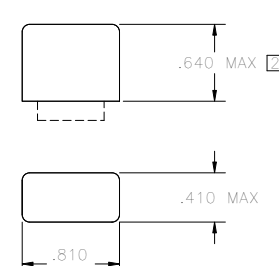

☐ RELAY HEIGHT MAY BE INCREASED .100 INCH FOR "N" SUPPRESSED COILS

MOUNTING STYLE A

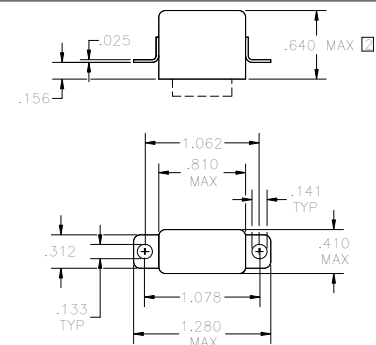

☐ RELAY HEIGHT MAY BE INCREASED .100 INCH FOR "N" SUPPRESSED COILS

MOUNTING STYLE D

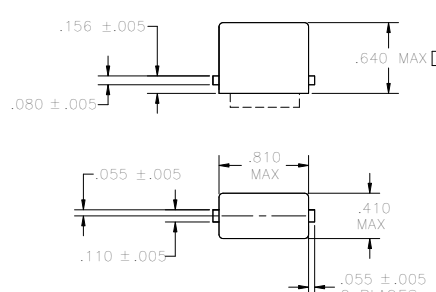

☐ RELAY HEIGHT MAY BE INCREASED .100 INCH FOR "N" SUPPRESSED COILS

MOUNTING STYLE E

NOTES:

FOR USE WITH TRACK MOUNT SYSTEM, MT-3000-003 AND SM-1000-003

SILICONE GASKET NOT PROVIDED ON THIS MOUNTING STYLE.

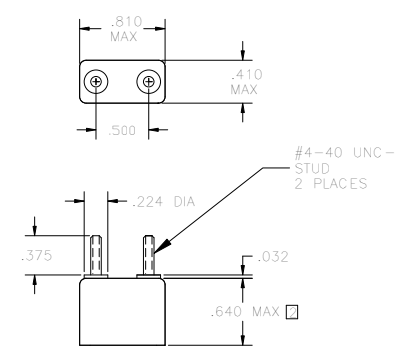

☐ RELAY HEIGHT MAY BE INCREASED .100 INCH FOR "N" SUPPRESSED COILS

MOUNTING STYLE G

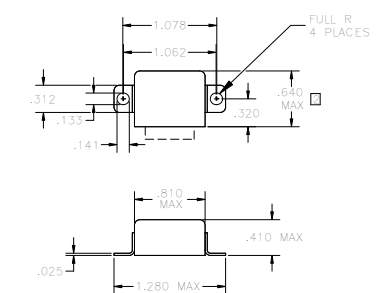

☐ RELAY HEIGHT MAY BE INCREASED .100 INCH FOR "N" SUPPRESSED COILS

MOUNTING STYLE J

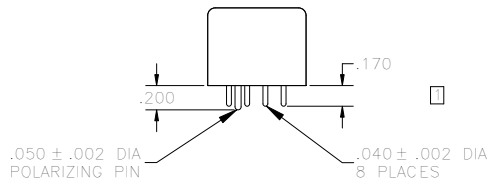

INSULATOR P/N RC-RP800050-3 AVAILABLE FROM ROBISON ELECTRONICS, SAN LUIS OBISPO, CA

TERMINAL TYPE 1

FINISH:
BODY - TIN/LEAD
TERMINALS - TIN/LEAD

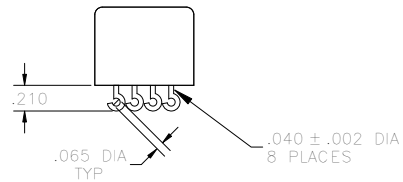

TERMINAL TYPE 2

FINISH:
BODY - TIN/LEAD
TERMINALS - TIN/LEAD

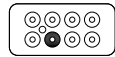
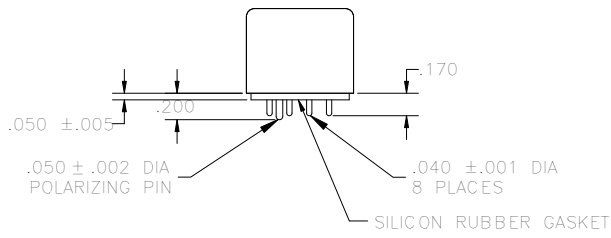

TERMINAL TYPE 4

FINISH:
BODY - TIN/LEAD
TERMINALS - GOLD PLATED

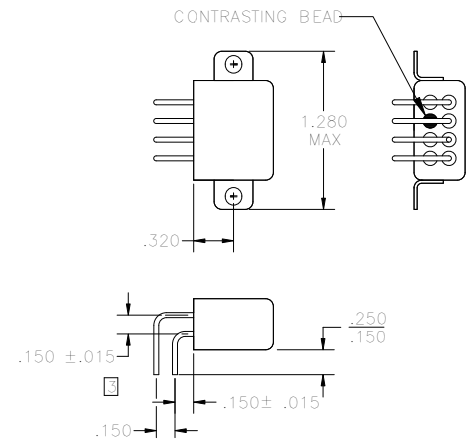

THIS END OF THE PIN WILL LIE WITHIN A CIRCULAR TOLERANCE ZONE; THE DIAMETER OF WHICH WILL BE 0.100 (8 PLACES).

TERMINAL TYPE 7

FINISH:
BODY - TIN/LEAD
TERMINALS - TIN/LEAD

SCHEMATIC DIAGRAM

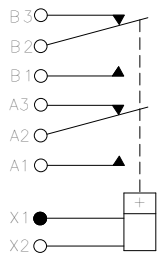

WIRING DIAGRAM

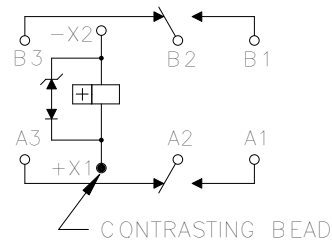

STANDARD TERMINAL LAYOUT

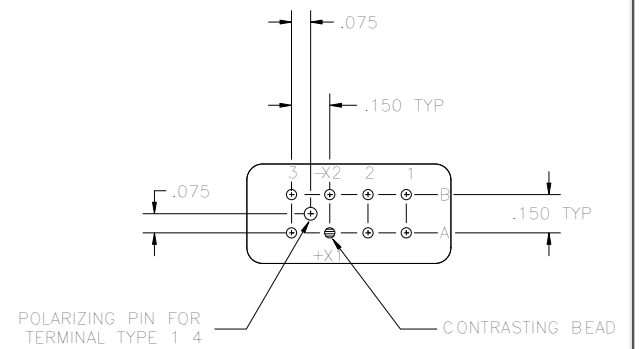

TOL: .XX ±.03; .XXX ±.010

DERATING OF CONTACTS FOR DC VOLTAGES ABOVE NOMINAL RATING

To establish a standard for the derating of relay contacts is, at best, a subjective practice. Limitations are governed by the type of relay, contact gap, maximum voltage capabilities of the relay contact system, and the contact material.

The most common method is to derate the contacts by use of the Power Formula, using the known current and voltage.

This method is valid only for **Resistive Loads**, and is an approximation only; keeping in mind the limitations mentioned above.

$$\text{Power} = IE \text{ (Current x Voltage)}$$

$$I_2 E_2 = 2/3 I_1 E_1$$

Example:

A designer is working with a 55 volt DC system and has a relay rated at 10 amps resistive at 28 volts DC. What is the maximum current that can be switched at 55 Vdc.

$$I_1 = 10 \text{ Amperes}$$

$$E_1 = 28 \text{ VDC}$$

$$E_2 = 55 \text{ VDC}$$

$$I_2 = ? \text{ (Current ratings at 55 VDC Resistive)}$$

$$I_2 E_2 = 2 I_1 E_1 / 3$$

$$I_2 = 2 I_1 E_1 / E_2 \times 3$$

$$= 2 (10 \times 28) / 55 \times 3$$

$$= 560 / 165$$

$$I_2 = 3.4 \text{ Amperes at 55VDC}$$

In addition, the user should always be concerned about the following:

1. Derating contacts that are rated for less than 10 Amperes at nominal voltage.
2. Derating contacts for use in system voltages above 130 Volts DC

RELAYS AND TEMPERATURE VARIATIONS

Most relay parameters are specified as maximum values over the rated temperature range of the specific relay. Users often find that key parameters differ significantly at ambient temperature (20-25°C) and sometimes fall into the trap of specifying their system around these ambient parameters. Additionally the actual temperature experienced by the relay can be far in excess of existing ambient temperatures due to the heat generated by the coil current and the contact load. Figure 1 is the summary of temperature effects on relay electrical characteristics.

Temperature	Resistance	Current	Operating Voltage	Release Voltage	Operate Time	Release Time
Increase	UP	DOWN	UP	UP	UP	UP
Decrease	DOWN	UP	DOWN	DOWN	DOWN	DOWN

Fig. 1

The following formulas are sometimes useful in calculating the effects shown above.

1. Change in coil resistance due to change of ambient temperature can be calculated by the following formula.

$$R = R_{20} [1 + .0039 (T-20)]$$

Where: R = Coil resistance at given temperature
 R₂₀ = Coil resistance at 20°C
 T = °C Ambient temperature

"Rule of Thumb" : For each 10°C change of temperature, coil resistance will change approximately 4%.

2. High and low temperature pick up voltage:

$$E_2 = E_1 K_2,$$

Where: E₂ = Pick Up Voltage at T₂ temperature
 E₁ = Pick Up Voltage at 20°C
 K₂ = Coefficient of correction found on the graph in Fig. 2 at T₂

3. Calculation of coil temperature rise when R initial and R final are known:

$$\Delta T = (234.5 + T_1) (R_2/R_1 - 1)$$

ΔT = Temperature rise ($^{\circ}\text{C}$)

T_1 = Initial temperature ($^{\circ}\text{C}$)

R_1 = Initial resistance (Ohms)

R_2 = Final resistance (Ohms)

$$R_2 = K_2 R_1$$

Temperature can also be found by making the R_2/R_1 ratio = the coefficient of correction graph in Fig. 2, and then finding the corresponding temperature.

TEMPERATURE CORRECTION CHART FOR RESISTANCE

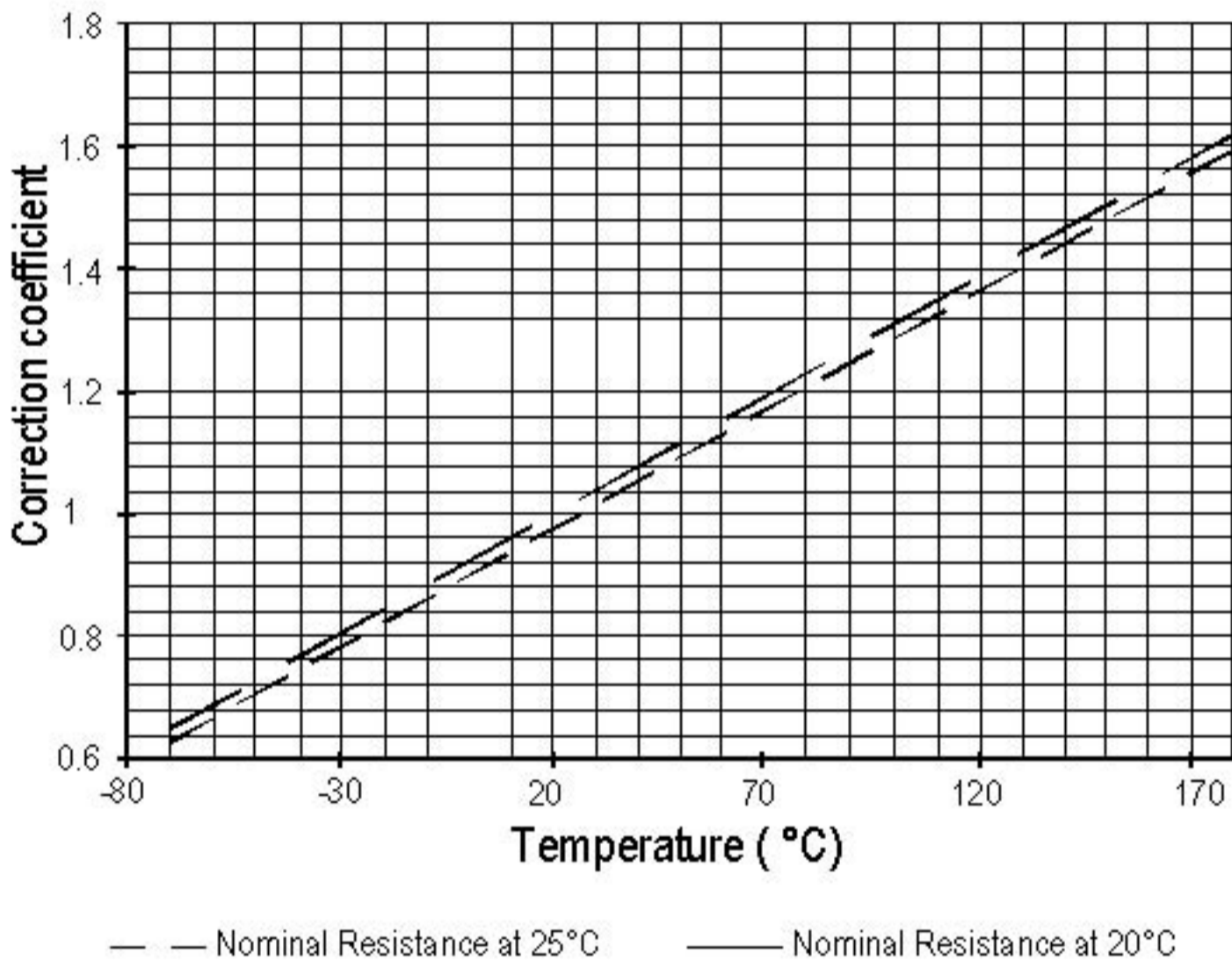

Fig. 2

EXAMPLE:

Catalog indicates coil resistance of 290 ohm at 25 $^{\circ}\text{C}$. What is the value at 125 $^{\circ}\text{C}$?

From the chart: $290 \times 1.39 = 403.31$ Ohms.

CURVES FOR DC VOLTAGES ABOVE NORMAL RATING: RESISTIVE LOAD ONLY
(without arc suppression)

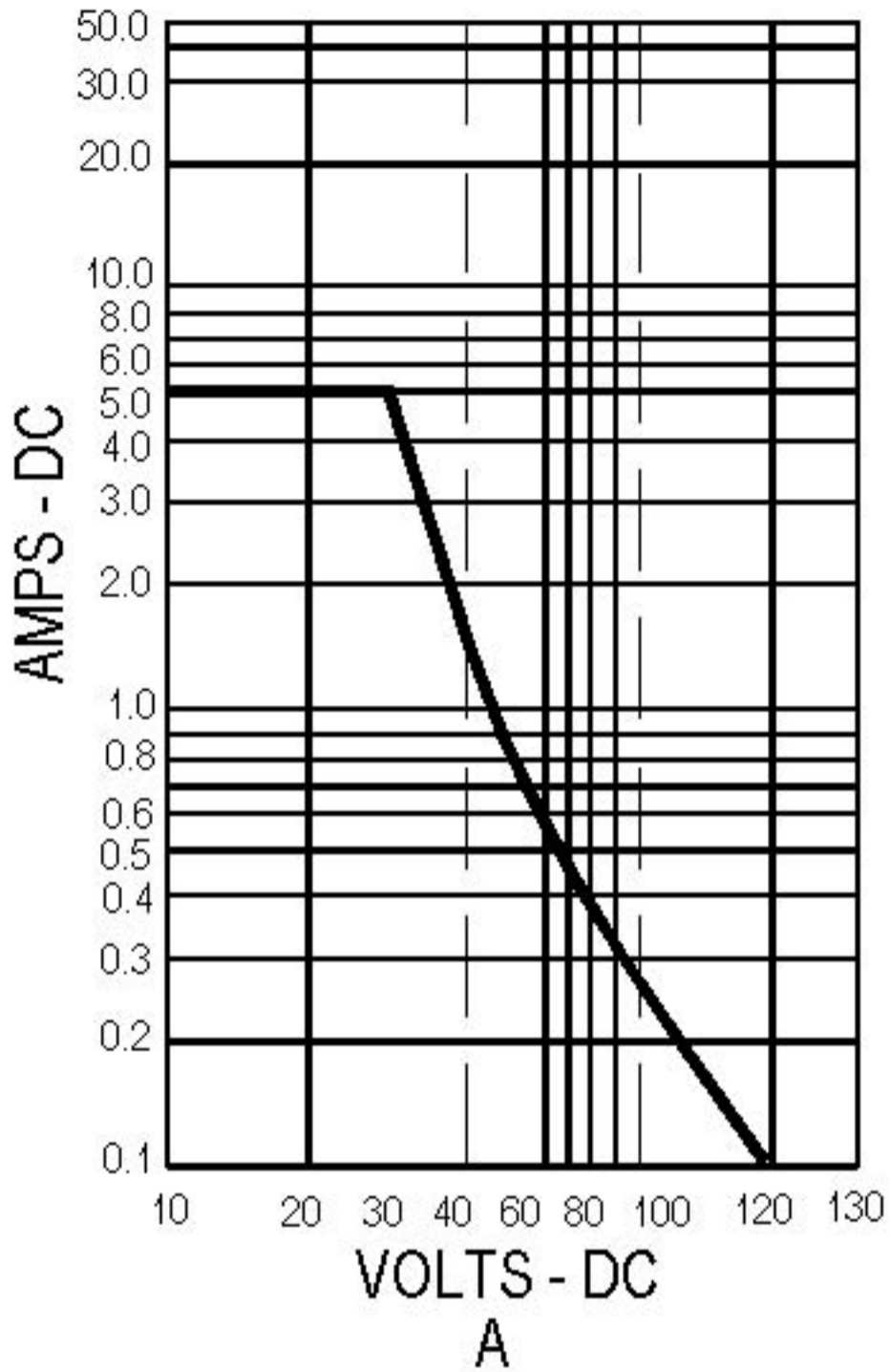

SUPPRESSOR DEVICES FOR RELAY COILS

The inductive nature of relay coils allows them to create magnetic forces which are converted to mechanical movements to operate contact systems. When voltage is applied to a coil, the resulting current generates a magnetic flux, creating mechanical work. Upon deenergizing the coil, the collapsing magnetic field induces a reverse voltage (also known as back EMF) which tends to maintain current flow in the coil. The induced voltage level mainly depends on the duration of the deenergization. The faster the switch-off, the higher the induced voltage.

All coil suppression networks are based on a reduction of speed of current decay. This reduction may also slow down the opening of contacts, adversely effecting contact life and reliability. Therefore, it is very important to have a clear understanding of these phenomena when designing a coil suppression circuitry.

Typical coil characteristics

On the graph below, the upper record shows the contacts state. (High level NO contacts closed, low level NC contacts closed, intermediate state contact transfer). The lower record shows the voltage across the coil when the current is switched off by another relay contact.

The surge voltage is limited to -300V by the arc generated across contact poles. Discharge duration is about 200 microseconds after which the current change does not generate sufficient voltage. The voltage decreases to the point where the contacts start to move, at this time, the voltage increases due to the energy contained in the NO contact springs. The voltage decreases again during transfer, and increases once more when the magnetic circuit is closed on permanent magnet.

Operating times are as follows:

Time to start the movement 1.5ms

Total motion time 2.3ms

Transfer time 1.4ms

Contact State

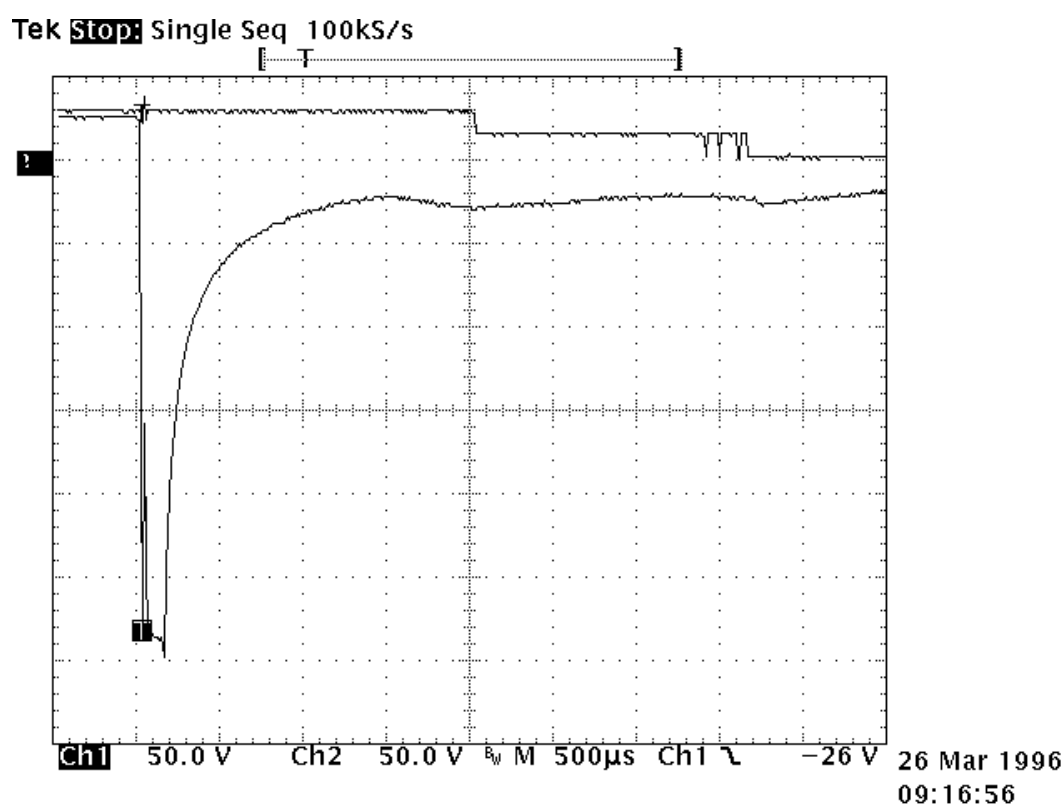

Types of suppressors:

Passive devices.

The resistor capacitor circuit

It eliminates the power dissipation problem, as well as fast voltage rises. With a proper match between coil and resistor, approximate capacitance value can be calculated from:

$C = 0.02 \times T/R$, where

T = operating time in milliseconds

R = coil resistance in kiloOhms

C = capacitance in microFarads

The series resistor must be between 0.5 and 1 times the coil resistance. Special consideration must be taken for the capacitor inrush current in the case of a low resistance coil.

The record shown opposite is performed on the same relay as above. The operation time becomes:

- time to start the movement 2.3ms

- transfer time 1.2ms

The major difficulty comes from the capacitor volume. In our example of a relay with a 290Ω coil and time delay of 8 ms, a capacitance value of $C=0.5 \mu\text{F}$ is found. This non polarized capacitor, with a voltage of 63V minimum, has a volume of about 1cm^3 . For 150V, this volume becomes 1.5cm^3 .

Tek **Stop:** Single Seq 100kS/s

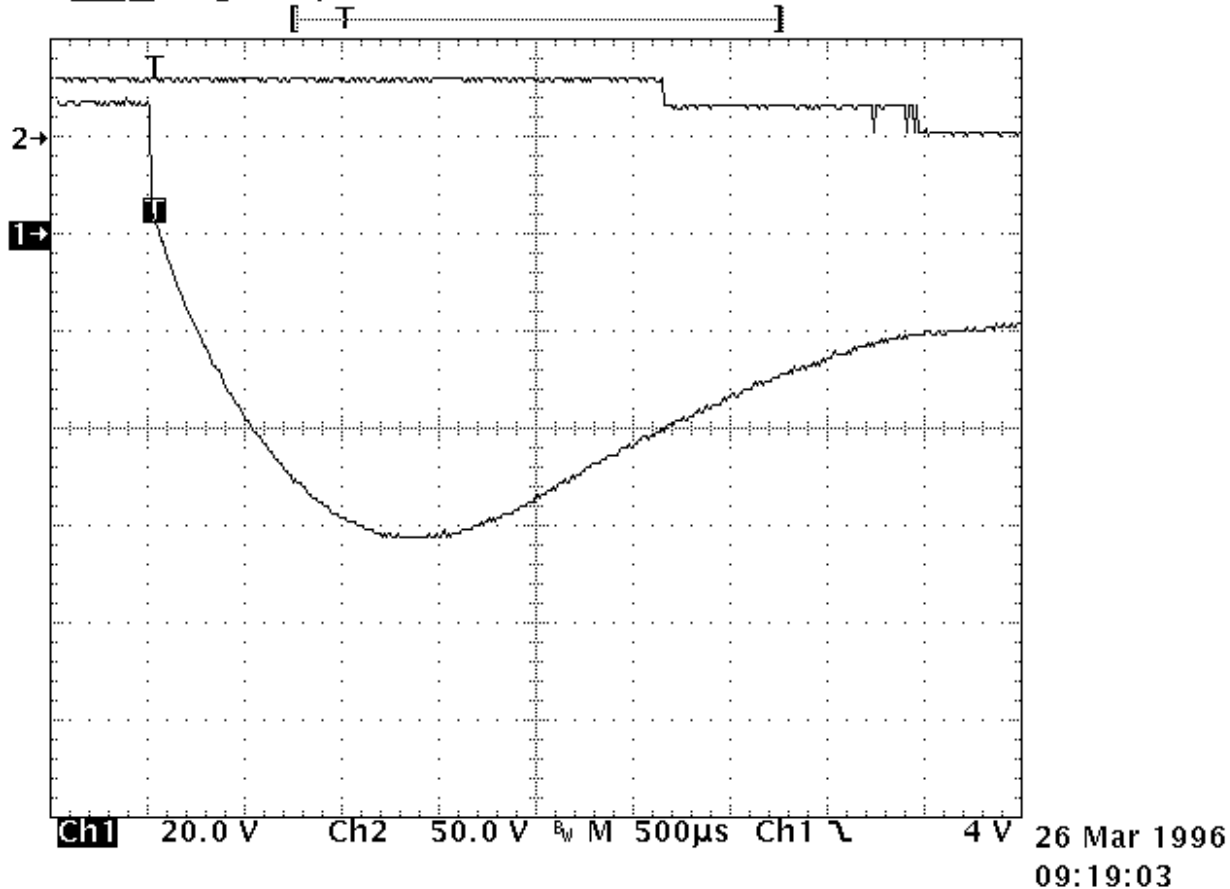

The bifilar coil

The principle is to wind on the magnetic circuit of the main coil a second coil shorted on itself. By a proper adaptation of the internal resistance of this second coil it is possible to find an acceptable equilibrium between surge voltage and reduction of the opening speed. To be efficient at fast voltage changes, the coupling of two coils must be perfect. This implies embedded windings. The volume occupied by the second coil reduces the efficiency of the main coil and results in higher coil power consumption. This method cannot be applied efficiently to products not specifically designed for this purpose.

The resistor (parallel with the coil)

For efficient action, the resistor must be of the same order of magnitude as the coil resistance. A resistor 1.5 times the coil resistance will limit the surge to 1.5 times the supply voltage. Release time and opening speed are moderately affected. The major problem is the extra power dissipated.

Semi-conductor devices

The diode

It is the most simple method to totally suppress the surge voltage. It has the major disadvantage of the higher reduction of contact opening speed. This is due to the total recycling, through the diode, of the energy contained in the coil itself. The following measurement is performed once again on the same relay. Operation times are given by the upper curve:

- time to start the movement 14ms
- transfer time 5ms

These times are multiplied by a coefficient from 4 to 8.

The lower curve shows the coil current. The increase prior to NO contact opening indicates that the contact spring dissipates its energy. At the opening time the current becomes constant as a result of practically zero opening speed.

Due to this kind of behavior, this type of suppression must be avoided for power relays. For small relays which have to switch low currents of less than 0.2 A, degradation of life is not that significant and the method may be acceptable.

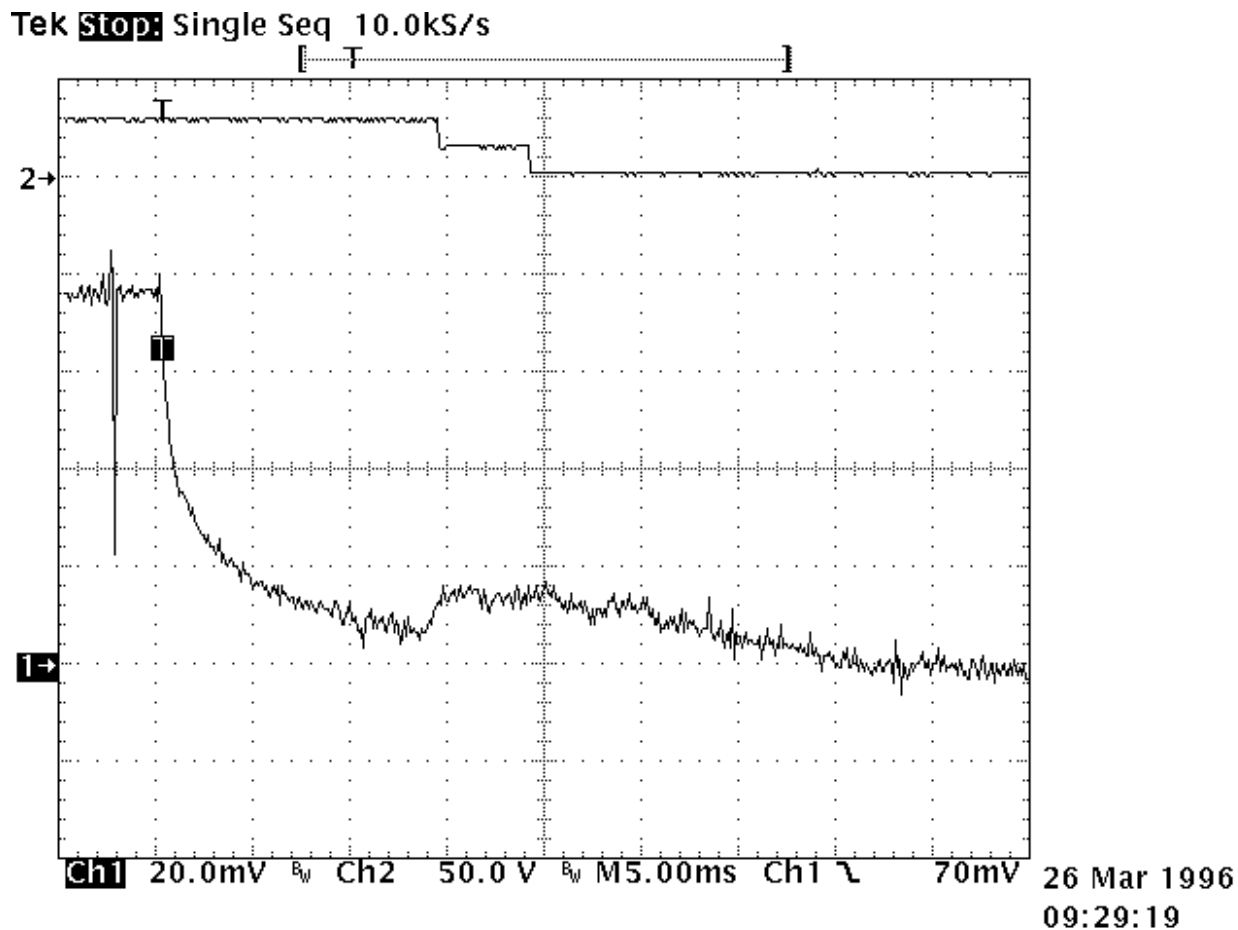

The diode + resistor network

It eliminates the inconvenience of the resistor alone, explained above, and it limits the action of a single diode. It is now preferred to use the diode + zener network.

The diode + zener network

Like the resistor, the zener allows a faster decurrent decay. In addition it introduces a threshold level for current conduction which avoids the recycling of energy released during contact movement.

The lower curve on the opposite record demonstrates those characteristics. Voltage limitation occurs at 42V. The two voltage spikes generated by internal movement are at lower levels than zener conduction. As a result, no current is recycled in the coil.

The opening time phases are as follows:

- time to start the movement 2.6ms
- total motion time 2.4ms
- transfer time 1.4ms

The release time is slightly increased. The contacts' opening speed remains unchanged.

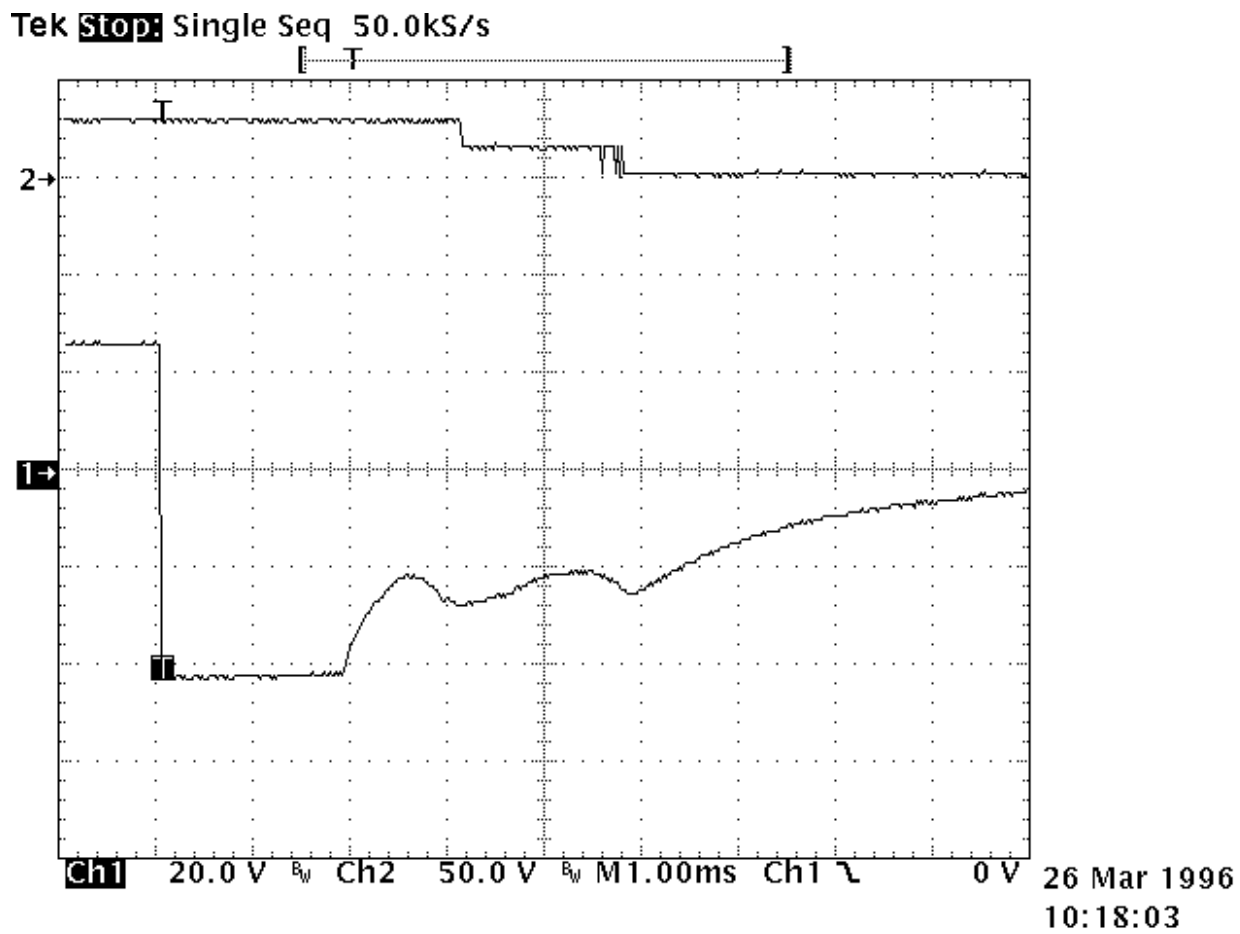

MOUNTING DISTANCE BETWEEN RELAYS
Applicable to XL, X, XA, XCL, XC,
YL, Y, YA, YCL, YC, YCA,
JS/JSA, JA, JL, J,
KA, KL, K

Definition and applicability

This application note defines the minimum distance between relays to insure relay performance as specified in our data sheets.

Phenomenon analysis

Each relay generates a magnetic field either when the relay is de-energized because of the permanent magnet or in the energized position because of permanent magnet and coil. The magnetic field generated by one relay could affect the performance of another relay when the below minimum distance between relays is not respected. If the relays are mounted adjacent to each other, it is advisable to alternate direction of magnetic path on every other unit and to keep a 1/16-inch space between relays (figure "A"). Or when mounted in the same direction, separate each relay from the other by 1/8 inch (figure "B"). If two or more rows of relays are installed, allow clearance of 1/8 inch between rows, (figures "C" and "D"). Provide 3/16-inch space between relays if used in opposition (figure "E").

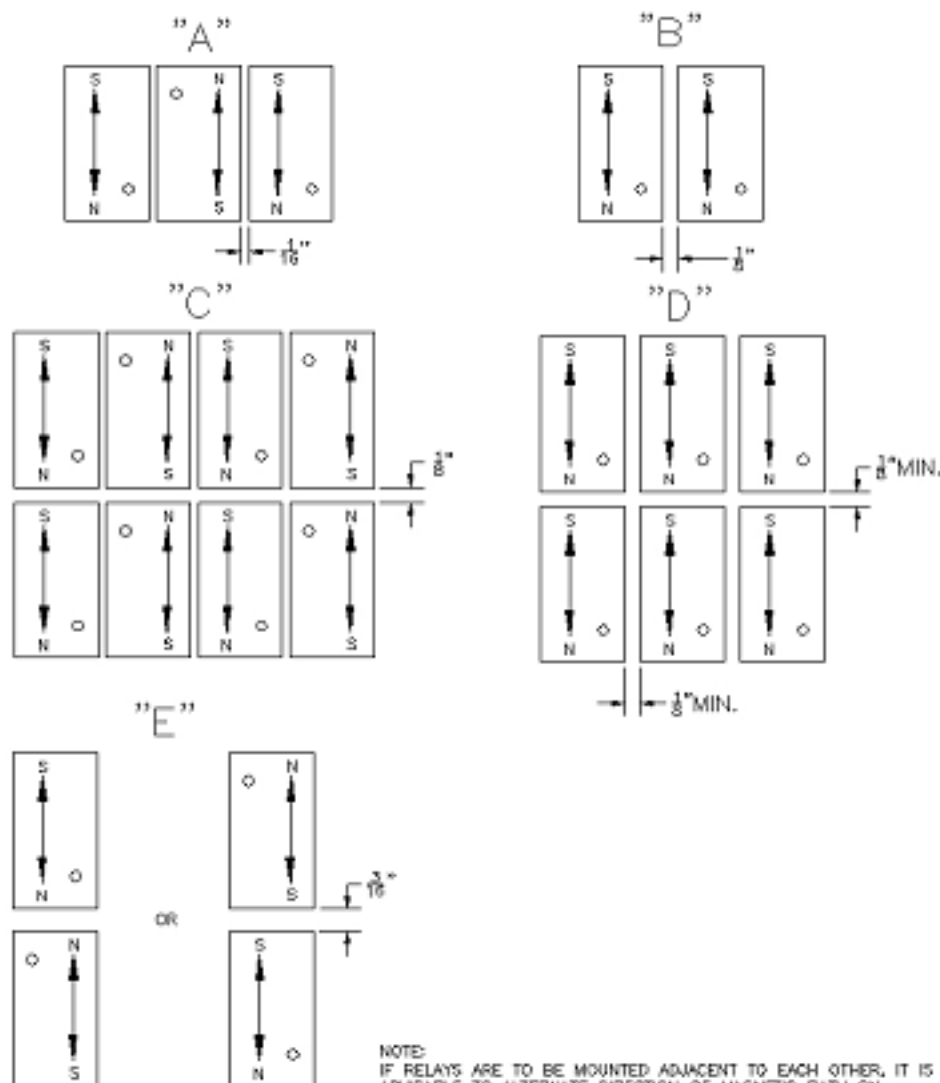

NOTE:
 IF RELAYS ARE TO BE MOUNTED ADJACENT TO EACH OTHER, IT IS ADVISABLE TO ALTERNATE DIRECTION OF MAGNETIC PATH ON EVERY OTHER UNIT AND TO KEEP A 1/16" SPACE BETWEEN RELAYS, FIGURE "A". OR, WHEN MOUNTED IN SAME DIRECTION SEPARATE EACH RELAY FROM THE OTHER BY 1/8 INCH MINIMUM, "B". IF TWO OR MORE ROWS OF RELAYS ARE TO BE INSTALLED, ALLOW CLEARANCE OF 1/8 INCH MINIMUM IN BETWEEN ROWS, "C" AND "D". PROVIDE FOR 3/16" SPACE BETWEEN RELAYS IF USED IN OPPOSING MAGNETIC DIRECTION, "E". REASONABLE CHANGE IN OPERATE VALUES MAY OCCUR IF INSTRUCTIONS ARE NOT FOLLOWED.

ENGINEERING DATA SHEET

SO-1064-001

RELAY SOCKET
5 AMP



BASIC SOCKET SERIES DESIGNATION FOR:

Series X

MEETS THE REQUIREMENTS OF:

MIL-DTL-12883

SOCKET DRAWING

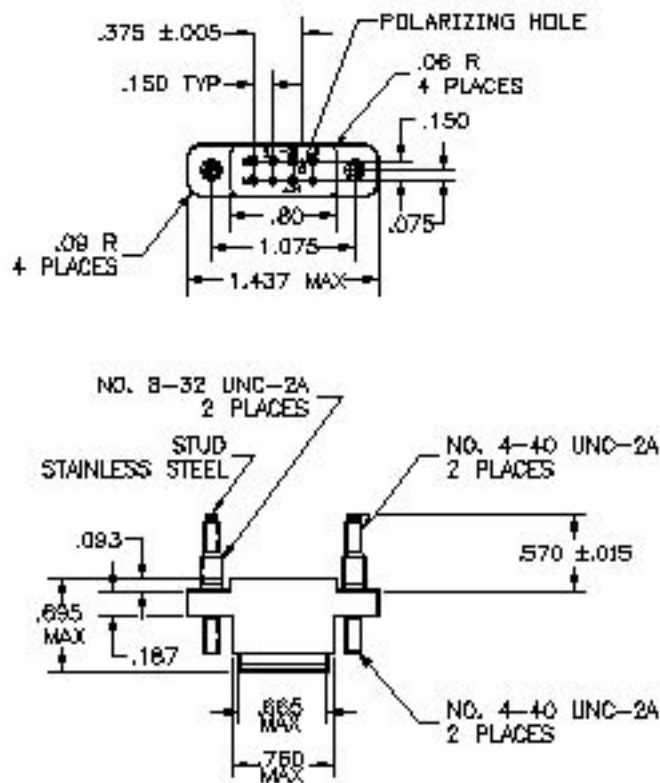

HARDWARE MOUNTING

MOUNTING DETAIL 2 PLACES

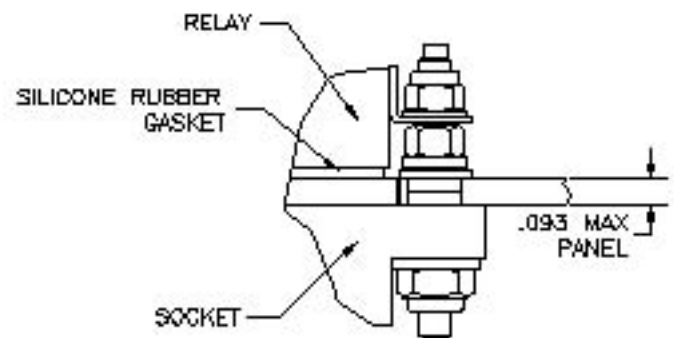

BOTTOM MOUNT—CLEARANCE
HOLE FOR .164 SCREW
TOP MOUNT—CLEARANCE
HOLE FOR .112 SCREW

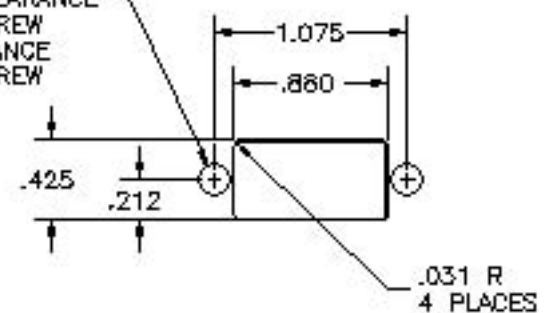

MOUNTING DIMENSIONS

GENERAL CHARACTERISTICS

1. Supplied with mounting hardware and No. 20 contacts and No. 20 crimp.

2. Standard tolerances

.xx ±.01; xxx ±.005

3. Weight

.030 lb. max

4. Temperature range

-70° C to +125° C



Featuring **LEACH**® power and control solutions
www.esterline.com

AMERICAS
6900 Orangethorpe Ave.
P.O. Box 5032
Buena Park, CA 90622

EUROPE
2 Rue Goethe
57430 Sarralbe
France

ASIA
Units 602-603 6/F Lakeside 1
No.8 Science Park West Avenue
Phase Two, Hong Kong Science Park
Pak Shek Kok, Tai Po, N.T.
Hong Kong

Tel: (01) 714-736-7599
Fax: (01) 714-670-1145

Tel: (33) 3 87 97 31 01
Fax: (33) 3 87 97 96 86

Tel: (852) 2 191 3830
Fax: (852) 2 389 5803

Data sheets are for initial product selection and comparison. Contact Esterline Power Systems prior to choosing a component.



APPLICABLE TRACK:
[MT-3000-003](#)

BASIC SOCKET SERIES DESIGNATION FOR:

Series YC (Track Mount)

QUALIFIED TO:

MIL-DTL-12883/52-002

SOCKET TRACK DRAWING

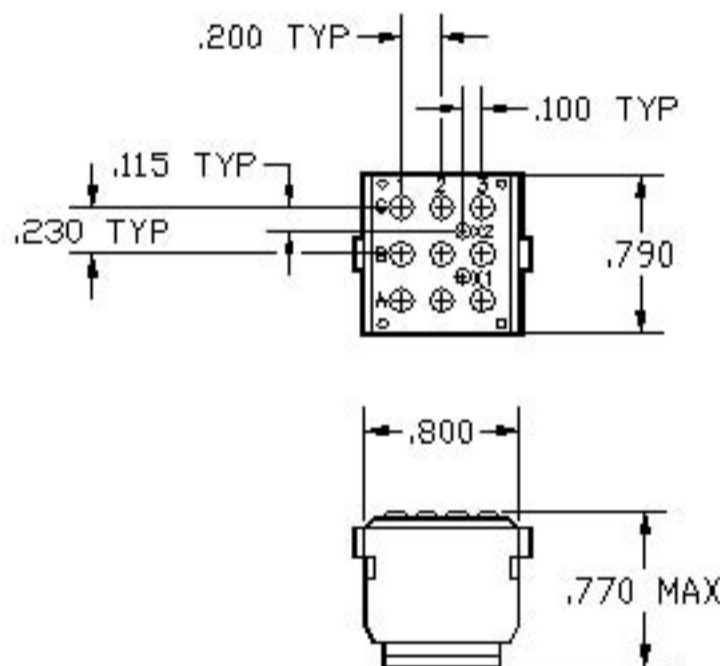

GENERAL CHARACTERISTICS

1. Supplied with No. 20 contacts and No. 20 crimp.

2. Standard tolerances

.xx ±.01; xxx ±.005.

3. Weight

.031 lb. max.

4. Used in conjunction with MT-3000-003



Featuring **LEACH**® power and control solutions
www.esterline.com

AMERICAS
6900 Orangethorpe Ave.
P.O. Box 5032
Buena Park, CA 90622

Tel: (01) 714-736-7599
Fax: (01) 714-670-1145

EUROPE
2 Rue Goethe
57430 Sarralbe
France

Tel: (33) 3 87 97 31 01
Fax: (33) 3 87 97 96 86

ASIA
Units 602-603 6/F Lakeside 1
No.8 Science Park West Avenue
Phase Two, Hong Kong Science Park
Pak Shek Kok, Tai Po, N.T.
Hong Kong

Tel: (852) 2 191 3830
Fax: (852) 2 389 5803

Data sheets are for initial product selection and comparison. Contact Esterline Power Systems prior to choosing a component.

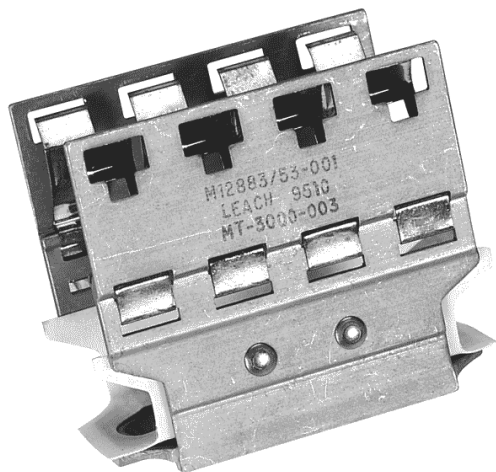

BASIC SOCKET SERIES DESIGNATION FOR:

Series SM Sockets (Track Mount)

MEETS THE REQUIREMENTS OF:

MIL-DTL-12883

SOCKET TRACK DRAWING

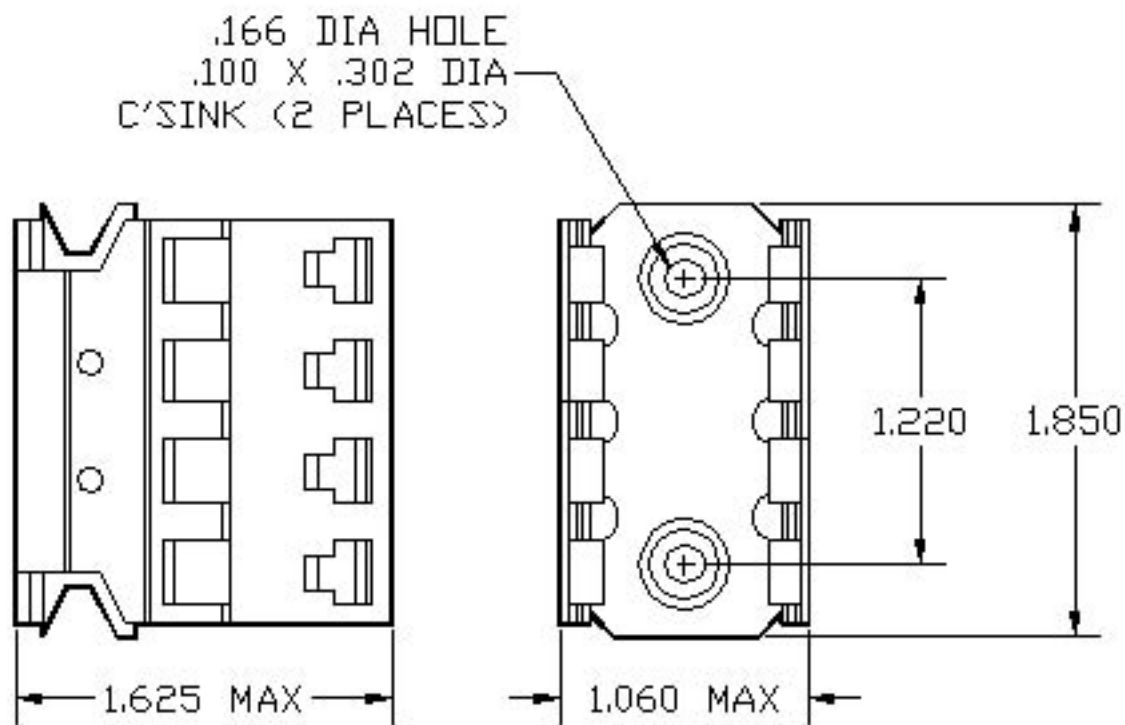

GENERAL CHARACTERISTICS

Used in conjunction with SM-1000-003, SM-1001-003 and SM-1002-003 track mount relay sockets.

Standard tolerances

.xx ±.01; xxx ±.005.

Weight

.056 lb. max.



Featuring **LEACH**® power and control solutions
www.esterline.com

AMERICAS
6900 Orangethorpe Ave.
P.O. Box 5032
Buena Park, CA 90622

Tel: (01) 714-736-7599
Fax: (01) 714-670-1145

EUROPE
2 Rue Goethe
57430 Sarralbe
France

Tel: (33) 3 87 97 31 01
Fax: (33) 3 87 97 96 86

ASIA
Units 602-603 6/F Lakeside 1
No.8 Science Park West Avenue
Phase Two, Hong Kong Science Park
Pak Shek Kok, Tai Po, N.T.
Hong Kong
Tel: (852) 2 191 3830
Fax: (852) 2 389 5803

Data sheets are for initial product selection and comparison. Contact Esterline Power Systems prior to choosing a component.