

TGC2510-SM

Ku-Band Upconverter



Applications

- VSAT
- Point-to-Point Radio
- Test Equipment & Sensors

2510
1249
5343

28-pin 5x5mm QFN package

Product Features

- RF Frequency Range: 10 - 16 GHz
- IF Frequency: DC – 3.5 GHz
- LO Frequency: 6.5 – 19 GHz
- LO Input Power: 0 to 6 dBm
- Conversion Gain: 17 dB
- OTOI: 33 dBm at max gain
- Attenuation Range: 15 dB typical
- Package Dimensions: 5.0 x 5.0 x 1.3 mm

Functional Block Diagram

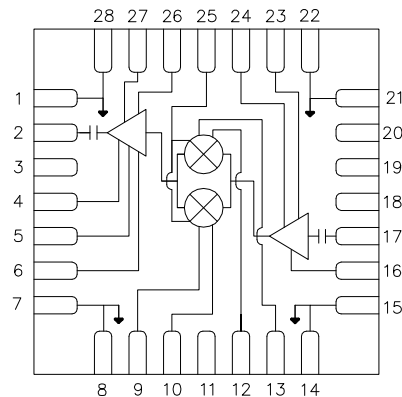

General Description

The TriQuint TGC2510-SM is a Ku-Band image reject up-converter with integrated LO buffer amplifier and output variable gain amplifier. The TGC2510-SM operates from an RF of 10 to 16 GHz and LO from 6.5 to 19 GHz with IF inputs from DC to 3.5GHz and is designed using TriQuint's pHEMT production process.

The TGC2510-SM typically provides 33 dBm of output TOI at -10 dBm input power per tone and has a conversion gain of 17 dB.

The TGC2510-SM is available in a low-cost, surface mount 28 lead 5x5mm QFN package and is ideally suited for Point-to-Point Radio, and Ku-Band VSAT Ground Terminal.

Lead-free and RoHS compliant.

Evaluation Boards are available upon request.

Pin Configuration

Pin #	Function Label
1, 7, 8, 9, 13, 14, 15, 16, 21, 22, 26, 28	GND
2	RF OUT
3, 11, 18, 19, 20	NC
4	VCTRL
5	VREF
6	VGRF
10	IF1
12	IF2
17	LO IN
23	VGLO
24	VDLO
25	VGX
27	VDRF

Ordering Information

Part No.	ECCN	Description
TGC2510-SM	EAR99	Ku-band Upconverter

Standard T/R size = 500 pieces on a 13" reel.

Specifications

Absolute Maximum Ratings

Parameter	Rating
VDRF	6 V
VDLO	6 V
IDRF	350 mA
IDLO	100 mA
VREF	3 V
VGRF, VGLO, VGX	-2 to +1.5 V
VCTRL	3 V
IF1, IF2	-2 to +2 V
RF Input Power, 50Ω, T = 25°C	10 dBm
Channel Temperature, T _{ch}	200 °C
Storage Temperature	-65 to 125°C

Operation of this device outside the parameter ranges given above may cause permanent damage.

Recommended Operating Conditions

Parameter	Min	Typ	Max	Units
Operating Temp. Range	-40	+25	+85	°C
VDRF		5		V
IDRF		240		mA
VGRF		-0.70		V
VDLO		5		V
IDLO		60		mA
VGLO		-0.63		V
VREF		2		V
VGX		-1.2		V
VCTRL		0		V
LO Input Power	0		6	dBm

Electrical specifications are measured at specified test conditions. Specifications are not guaranteed over all recommended operating conditions.

Electrical Specifications

Test conditions unless otherwise noted: IF Input Power = -10 dBm, VGX = -1.2 V, VREF = 2 V, VDLO = 5 V, IDLO = 60 mA, VDRF = 5 V, IDRF = 240 mA, VCTRL = 0 V, for maximum gain.

Parameter	Conditions	Min	Typ	Max	Units
RF Frequency Range		10		16	GHz
LO Frequency Range		6.5		19	GHz
IF Frequency Range		DC		3.5	GHz
LO Input Power		0		6	dBm
Conversion Gain			17		dBm
OIP3			33		dBm
IMR			20		dB

Specifications

Thermal and Reliability Information

Parameter	Condition	Rating
Thermal Resistance, θ_{JC} , measured to back of package	Tbase = 85 °C	$\theta_{JC} = 26.1 \text{ }^{\circ}\text{C/W}$
Channel Temperature (Tch), and Median Lifetime (Tm)	Tbase = 85 °C, VDRF = 5 V, IDRF = 240 mA VDLO = 5 V, IDLO = 60 mA P _{diss} = 1.5 W	Tch = 124 °C Tm = 2.3 E+7 Hours
Channel Temperature (Tch), and Median Lifetime (Tm) Under RF Drive	Tbase = 85 °C VDRF = 5 V, IDRF = 240 mA VDLO = 5 V, IDLO = 85 mA Pin = -10 dBm P _{diss} = 1.63 W	Tch = 128 °C Tm = 1.4 E+7 Hours

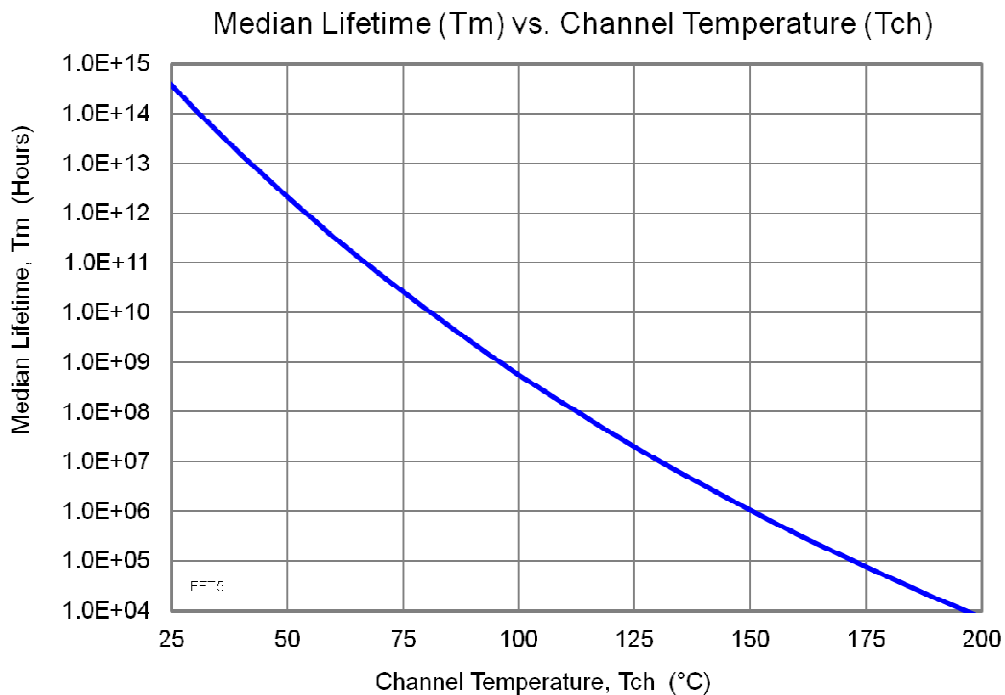

TGC2510-SM

Ku-Band Upconverter



Typical Performance

IF Input Power = -10 dBm, VDLO = 5 V, IDLO = 60 mA, VDRF = 5 V, IDRf = 240 mA, VGX = -1.2 V, VREF = 2 V.
 Data taken with external IF hybrid and LO nulling applied.

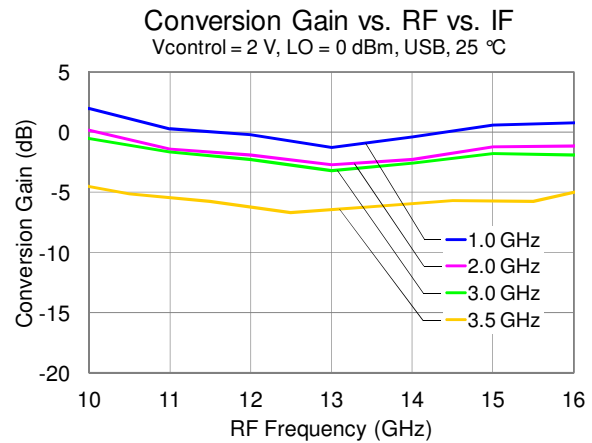
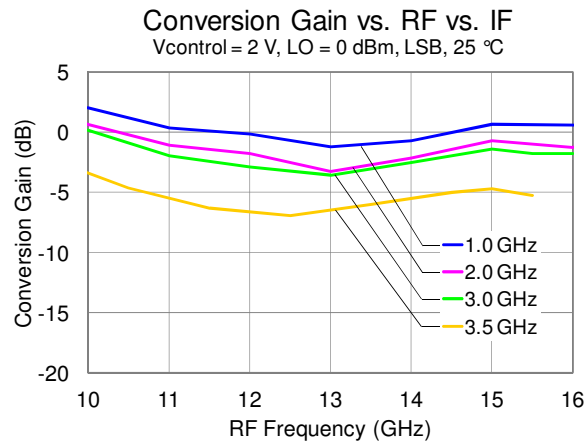
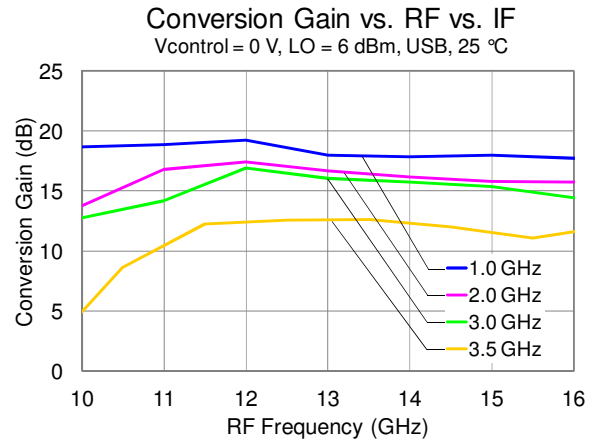
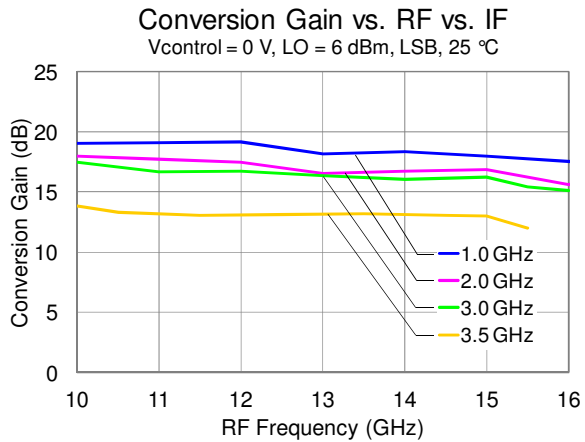
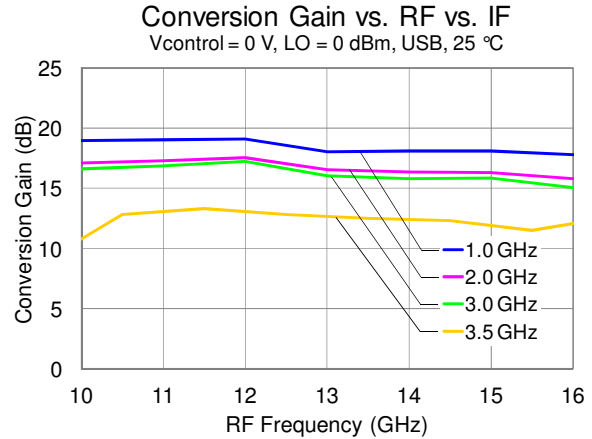
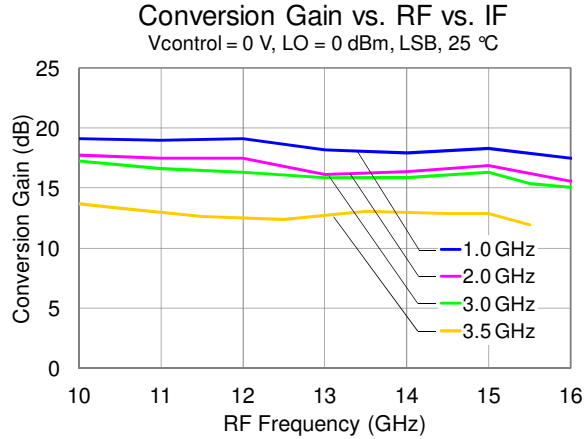

Typical Performance

IF Input Power = -10 dBm, VDLO = 5 V, IDLO = 60 mA, VDRF = 5 V, IDRf = 240 mA, VGX = -1.2 V, VREF = 2 V.
 Data taken with external IF hybrid and LO nulling applied.

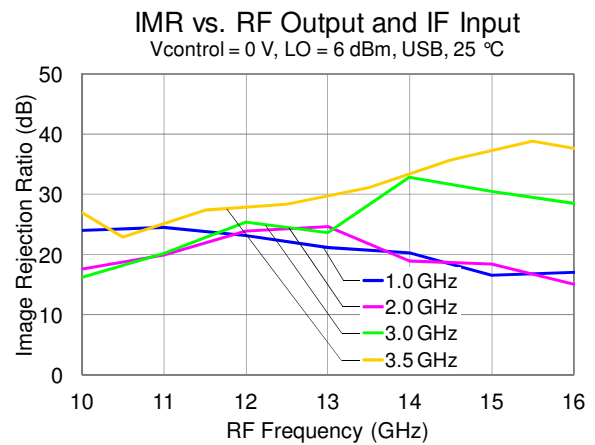
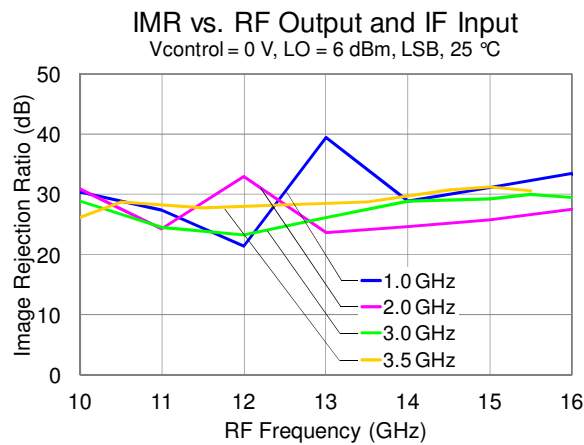
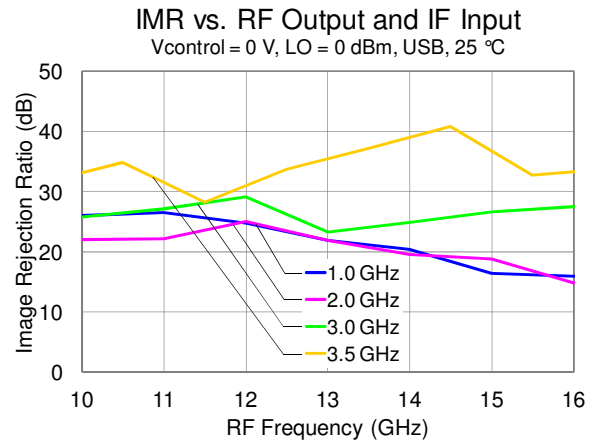
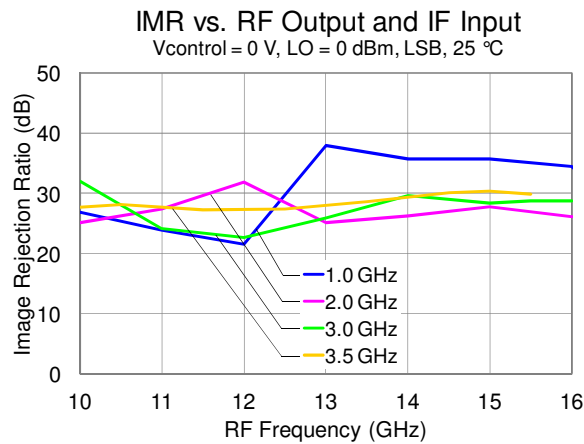
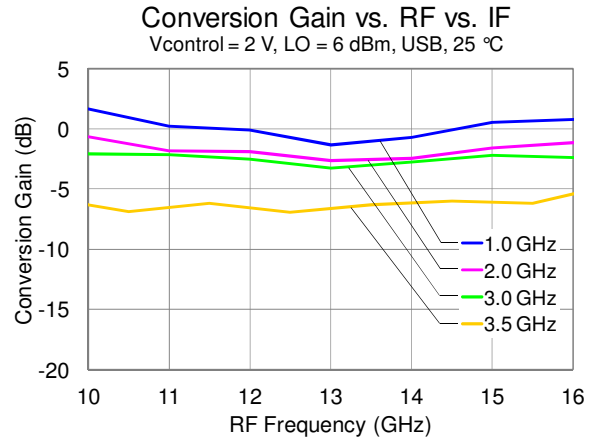
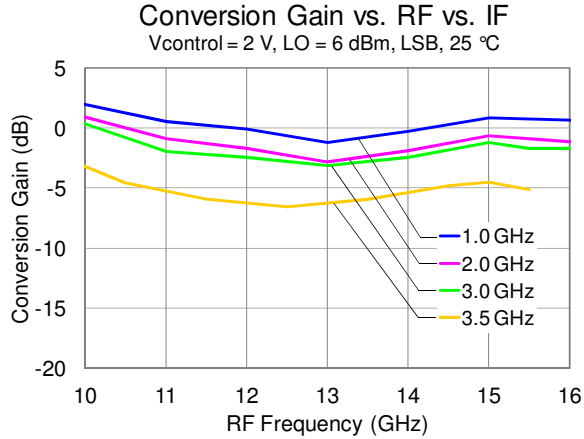

Typical Performance

IF Input Power = -10 dBm, VDLO = 5 V, IDLO = 60 mA, VDRF = 5 V, IDRF = 240 mA, VGX = -1.2 V, VREF = 2 V.
 Data taken with external IF hybrid and LO nulling applied.

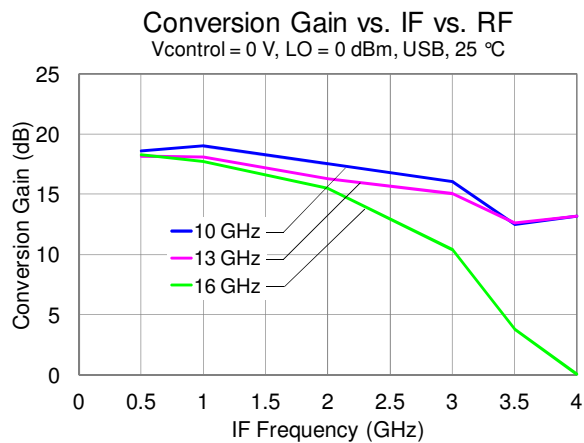
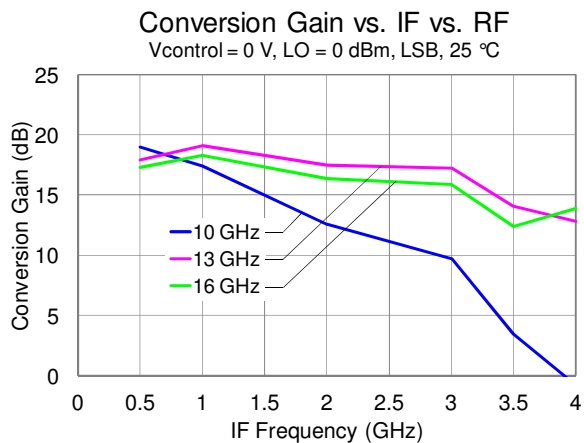
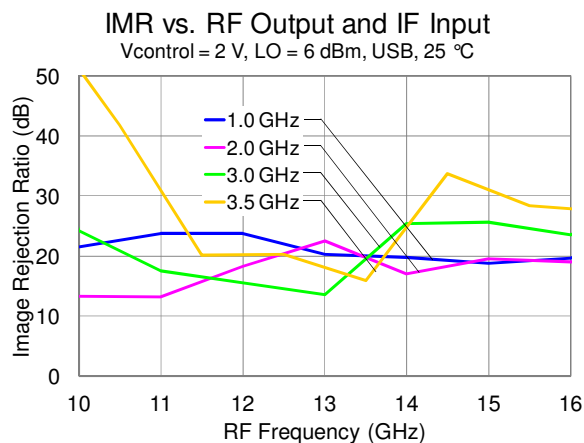
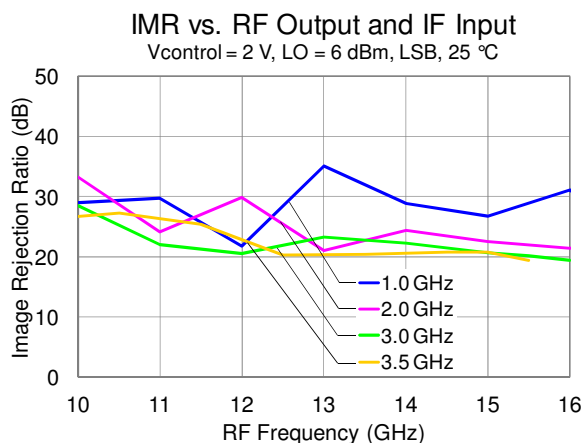
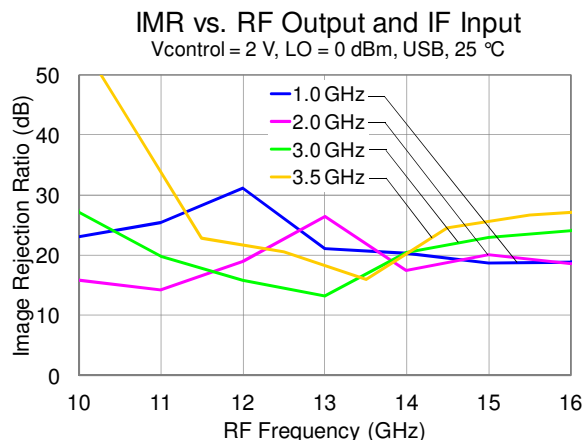
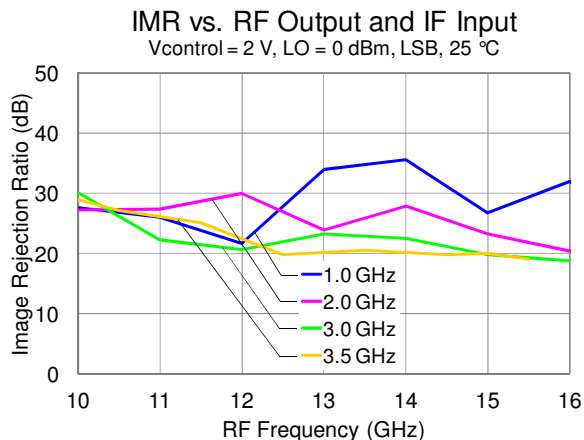

Typical Performance

IF Input Power = -10 dBm, VDLO = 5 V, IDLO = 60 mA, VDRF = 5 V, IDRF = 240 mA, VGX = -1.2 V, VREF = 2 V.
 Data taken with external IF hybrid and LO nulling applied

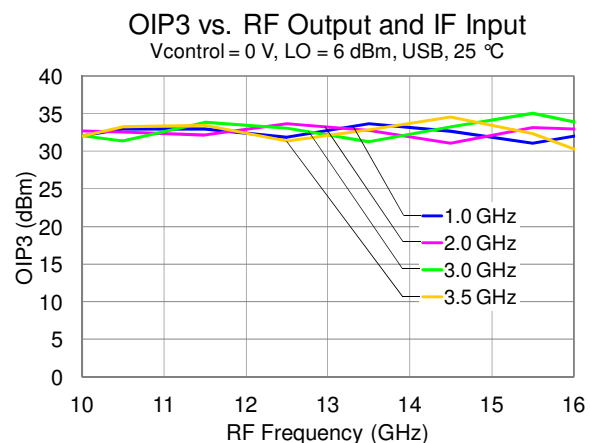
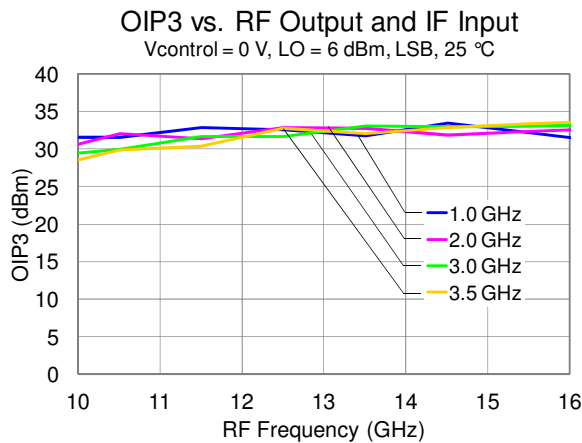
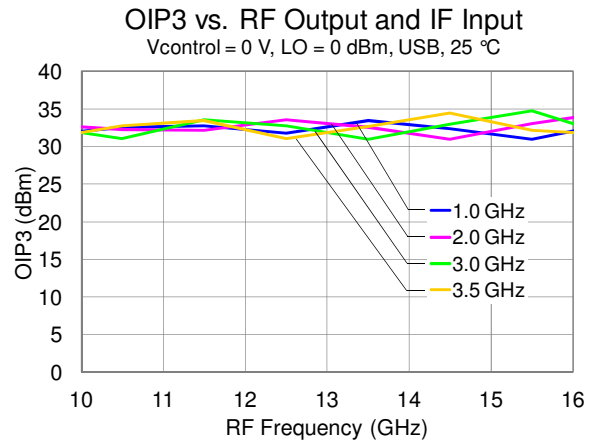
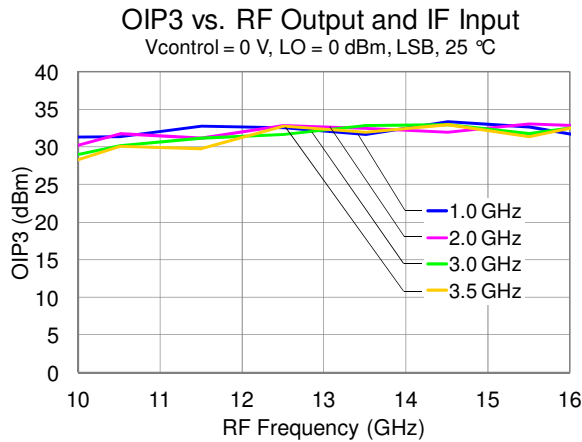
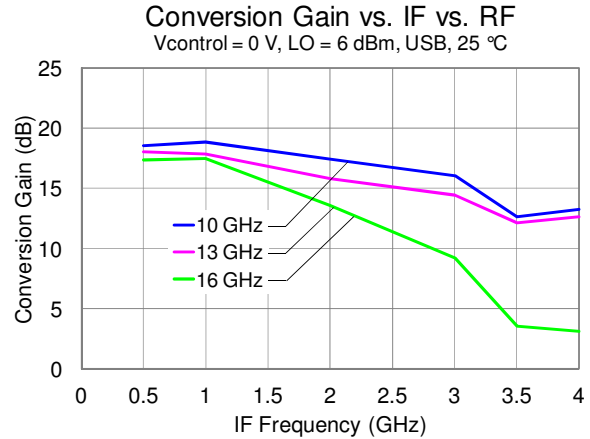
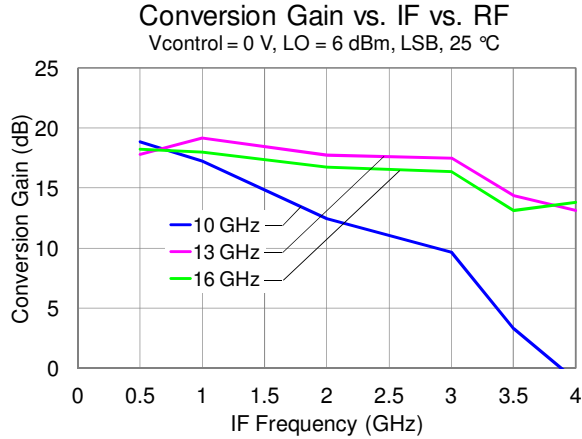

Typical Performance

IF Input Power = -10 dBm, VDLO = 5 V, IDLO = 60 mA, VDRF = 5 V, IDRF = 240 mA, VGX = -1.2 V, VREF = 2 V.
 Data taken with external IF hybrid and LO nulling applied.

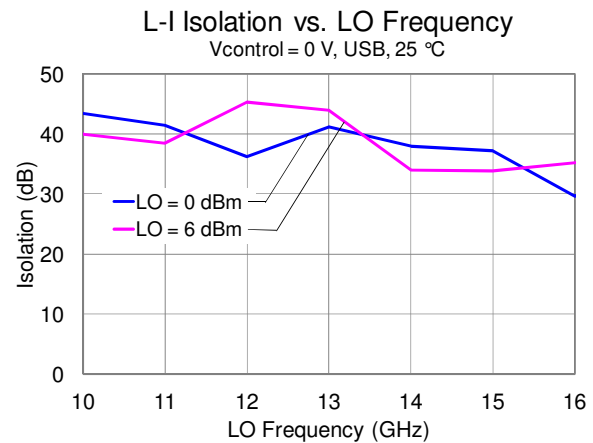
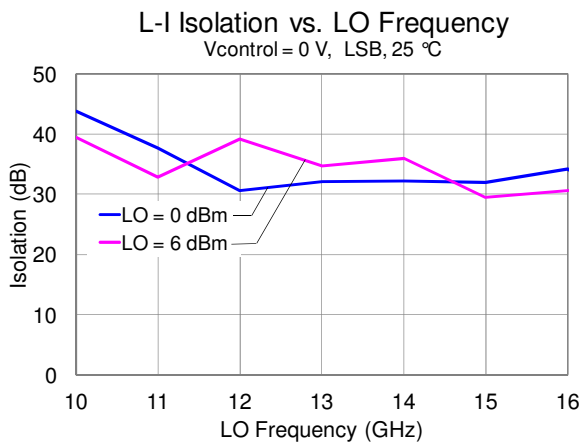
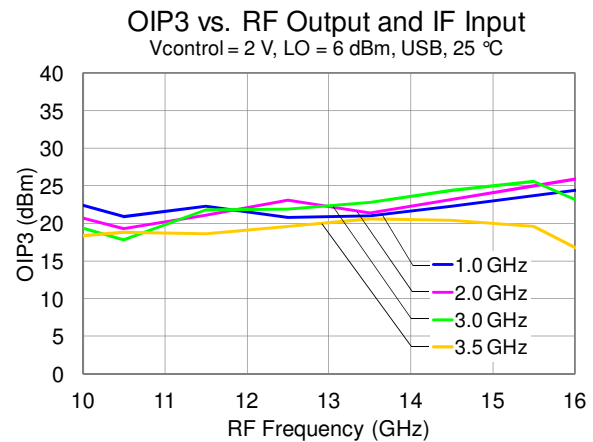
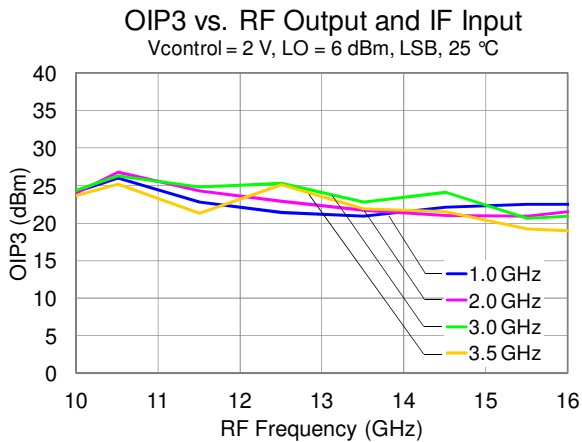
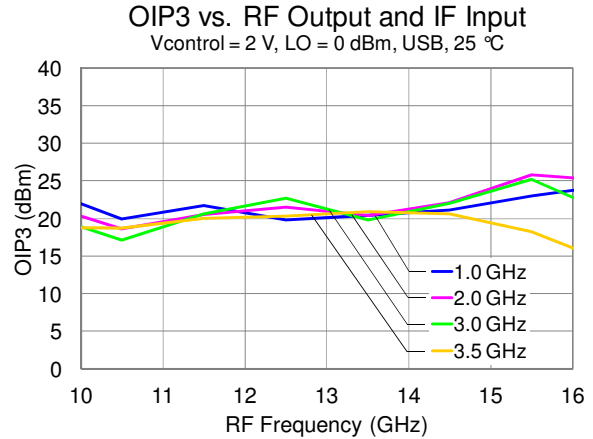
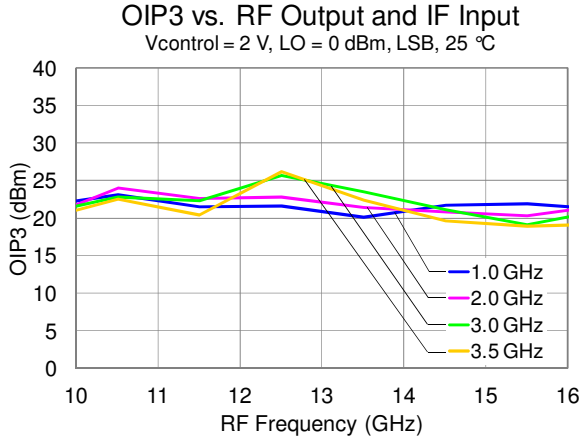

Typical Performance

IF Input Power = -10 dBm, VDLO = 5 V, IDLO = 60 mA, VDRF = 5 V, IDRF = 240 mA, VGX = -1.2 V, VREF = 2 V.
 Data taken with external IF hybrid and LO nulling applied.

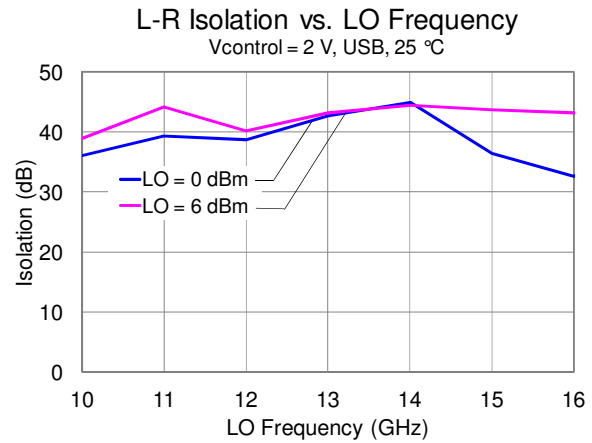
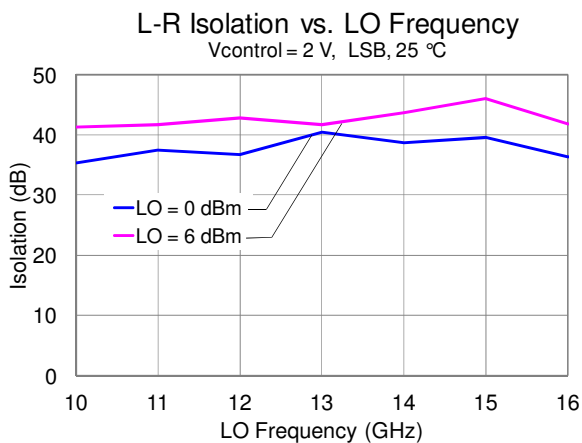
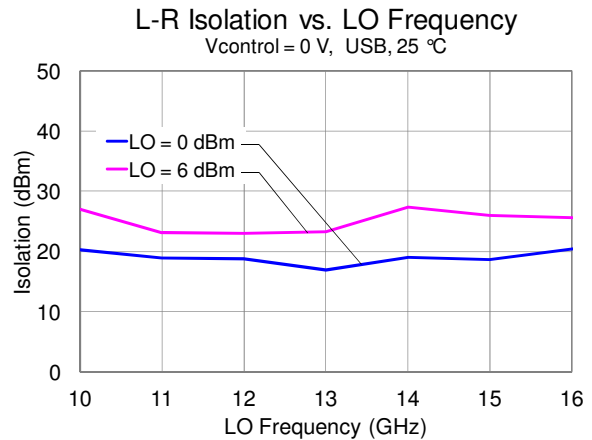
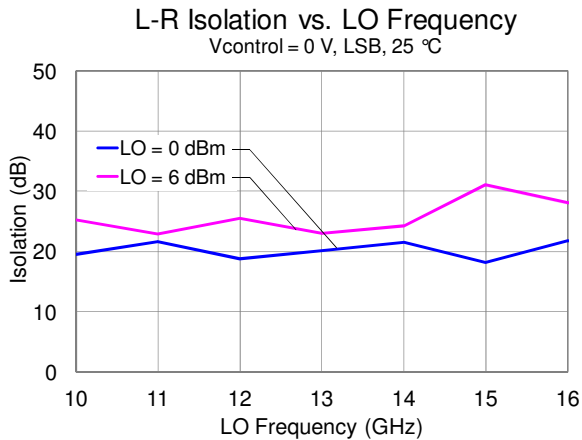
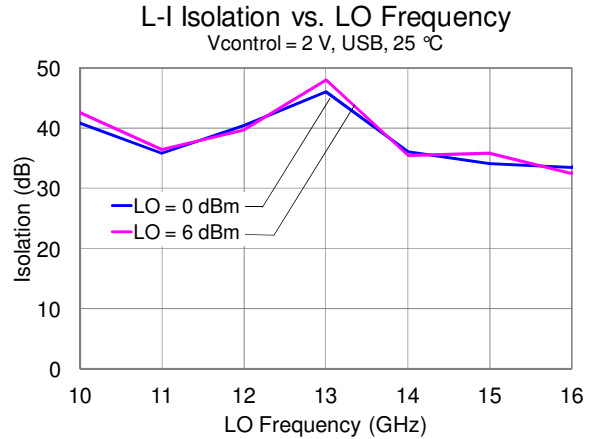
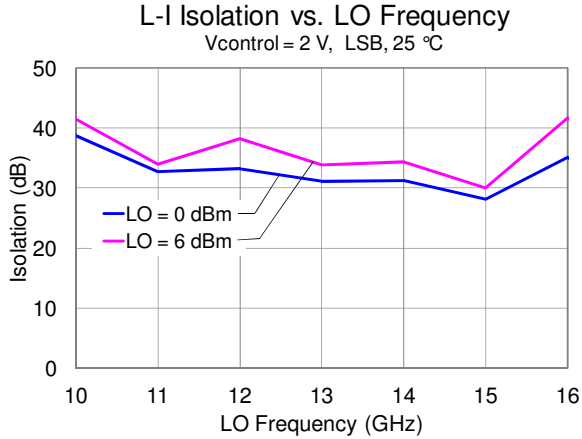

Typical Performance

IF Input Power = -10 dBm, VDLO = 5 V, IDLO = 60 mA, VDRF = 5 V, IDRf = 240 mA, VGX = -1.2 V, VREF = 2 V.
 Data taken with external IF hybrid and LO nulling applied

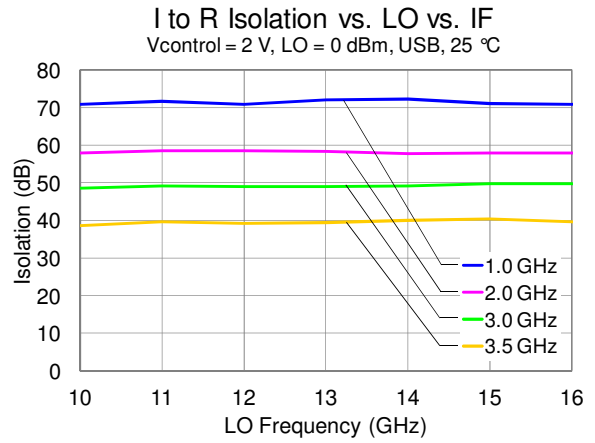
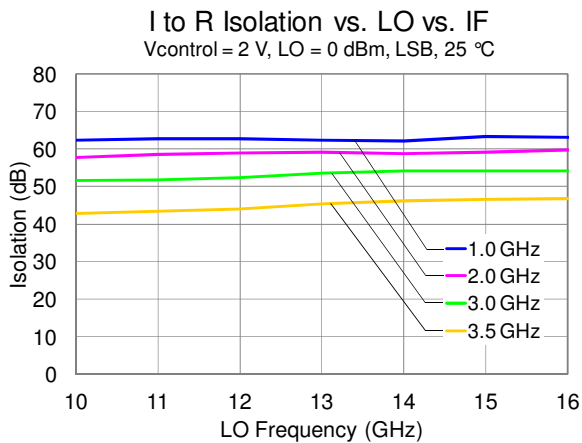
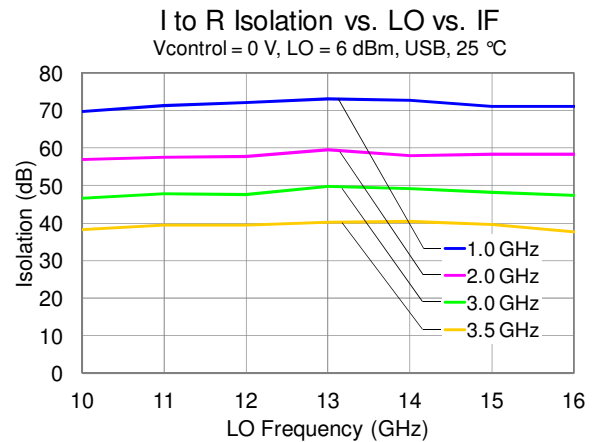
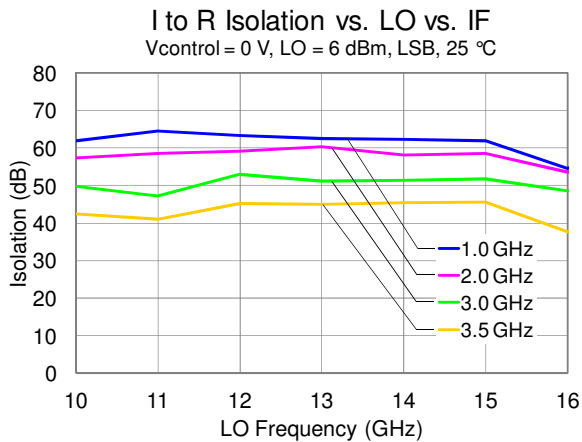
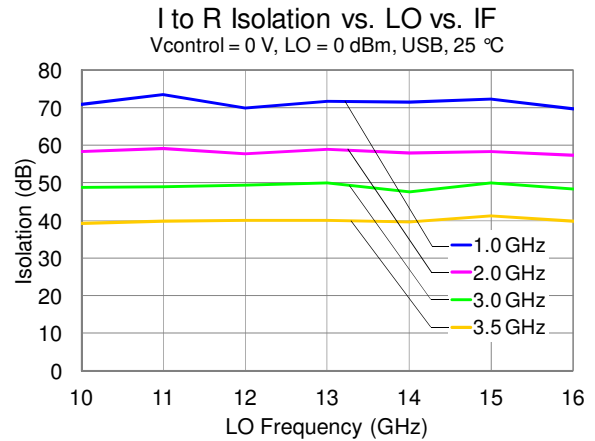
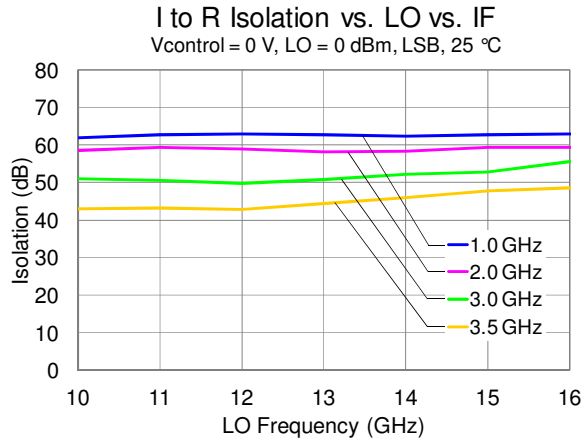

TGC2510-SM

Ku-Band Upconverter



Typical Performance

IF Input Power = -10 dBm, VDLO = 5 V, IDLO = 60 mA, VDRF = 5 V, IDRf = 240 mA, VGX = -1.2 V, VREF = 2 V.
 Data taken with external IF hybrid and LO nulling applied

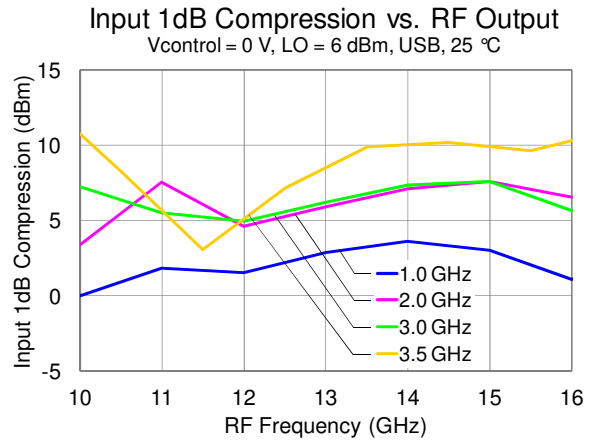
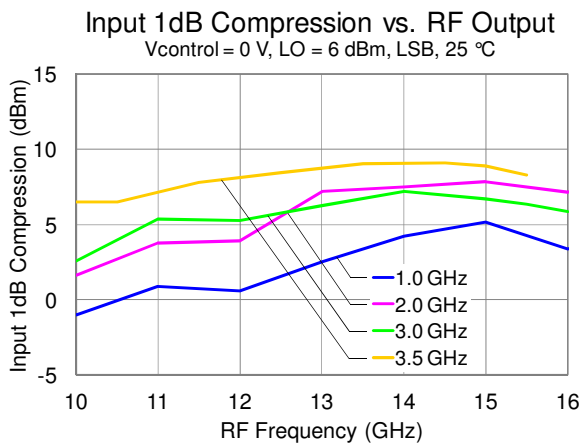
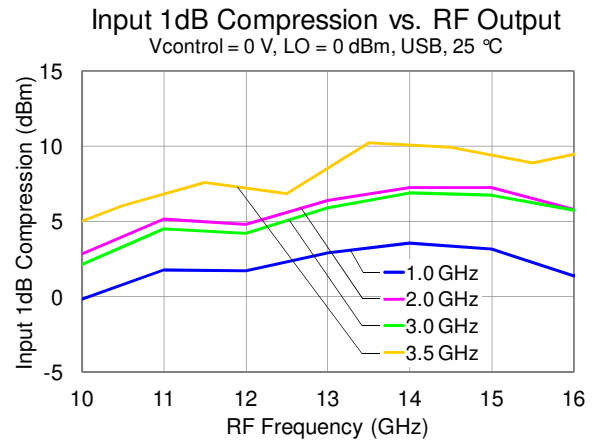
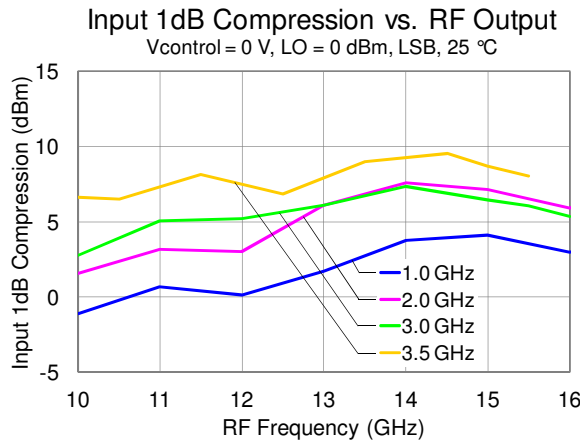
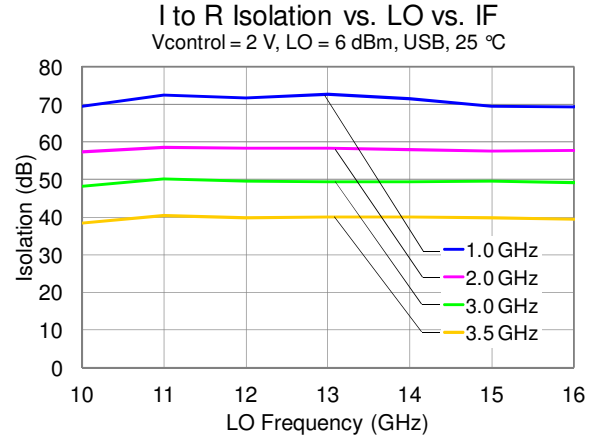
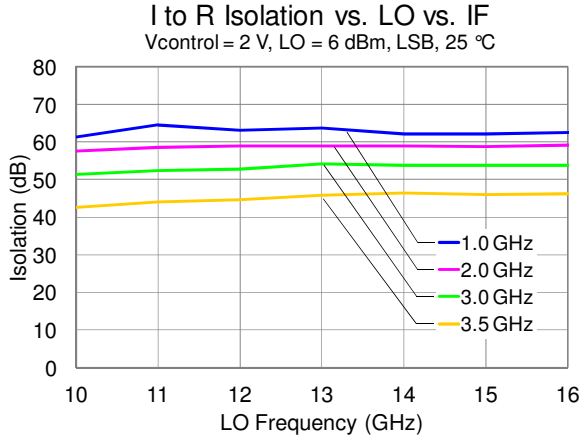

Typical Performance

IF Input Power = -10 dBm, VDLO = 5 V, IDLO = 60 mA, VDRF = 5 V, IDRF = 240 mA, VGX = -1.2 V, VREF = 2 V.
 Data taken with external IF hybrid and LO nulling applied.

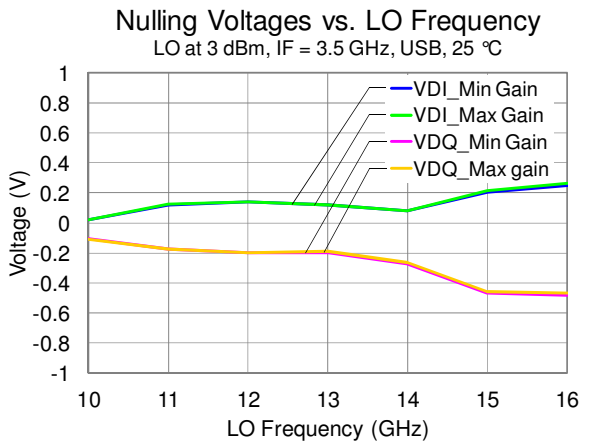
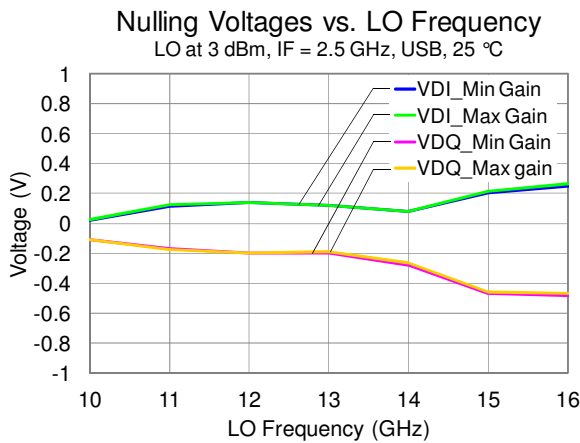
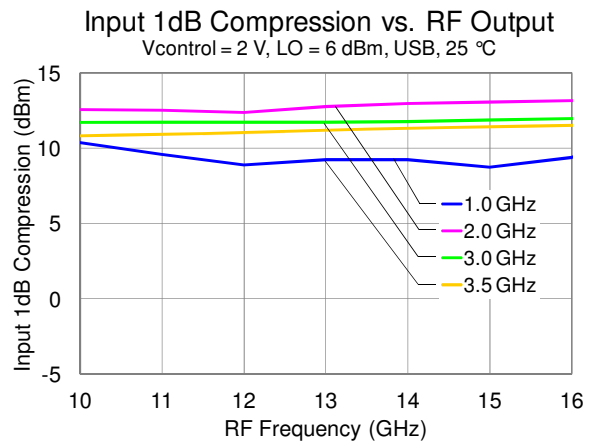
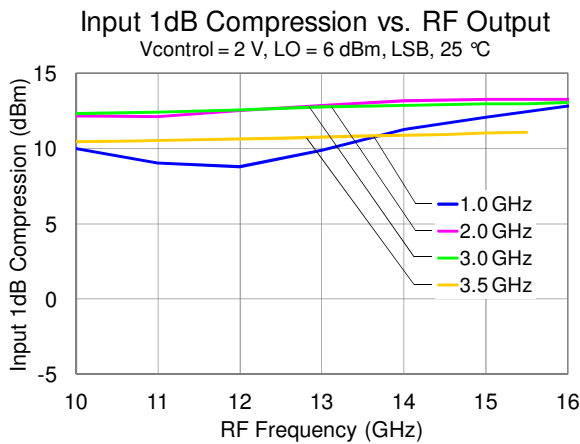
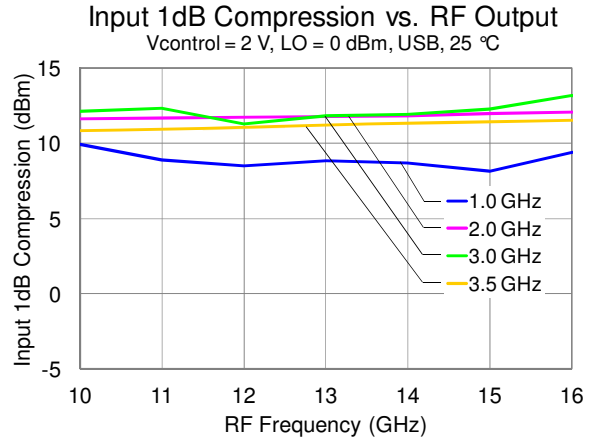
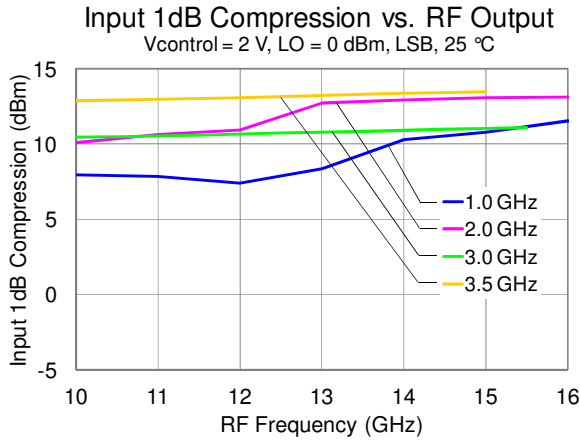

Typical Performance

IF Input Power = -10 dBm, VDLO = 5 V, IDLO = 60 mA, VDRF = 5 V, IDRf = 240 mA, VGX = -1.2 V, VREF = 2 V
 Data taken with external IF hybrid and LO nulling applied.

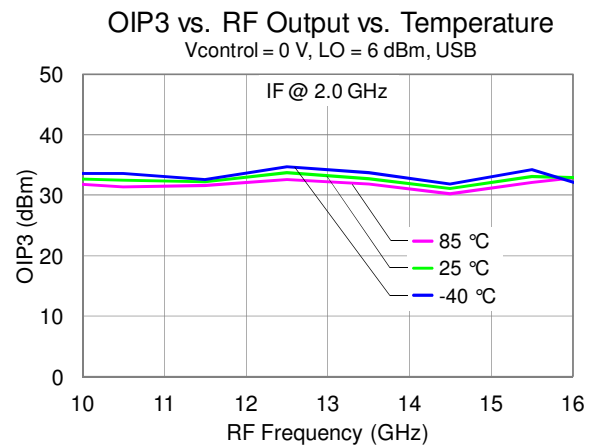
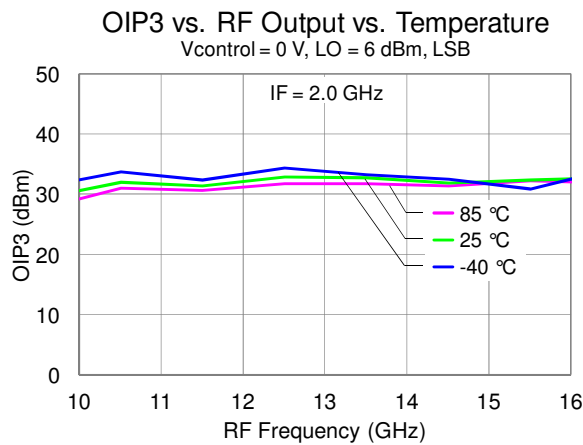
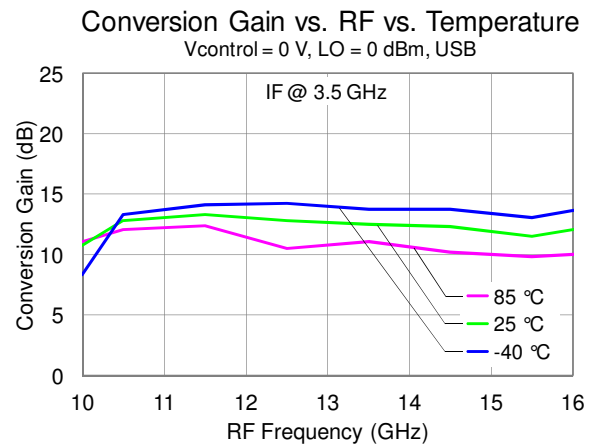
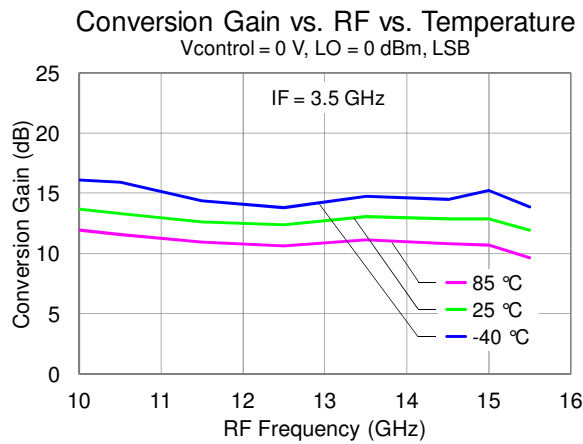
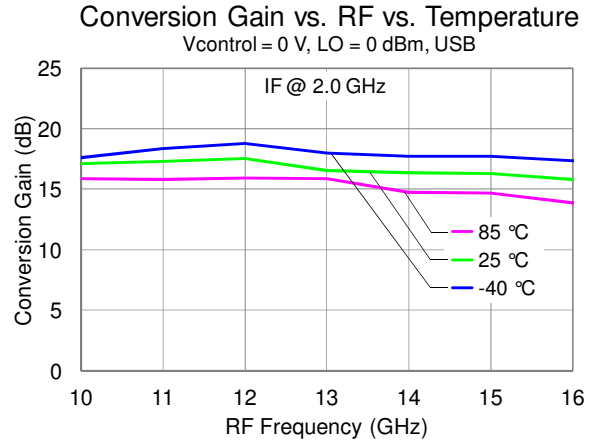
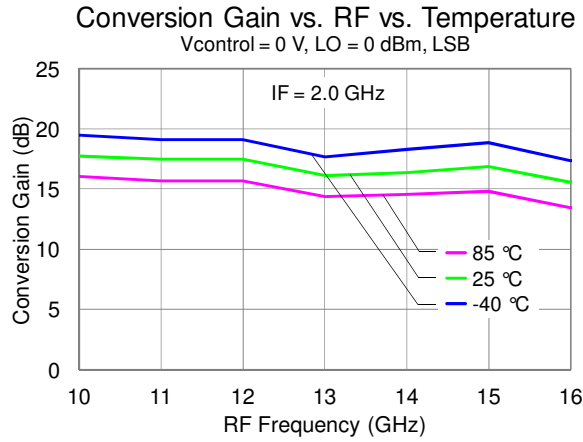

Typical Performance

IF Input Power = -10 dBm, VDLO = 5 V, IDLO = 60 mA, VDRF = 5 V, IDRF = 240 mA, VGX = -1.2 V, VREF = 2 V.
 Data taken with external IF hybrid and LO nulling applied

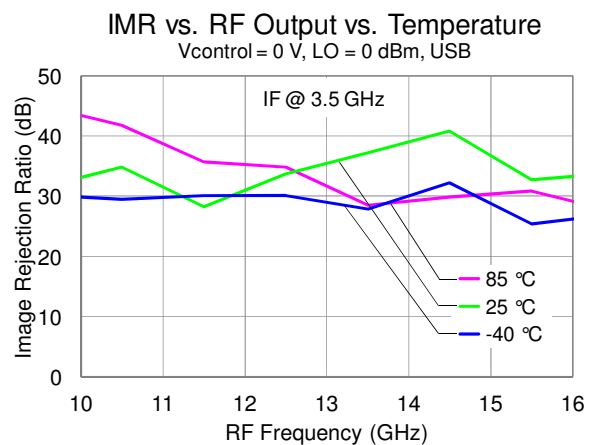
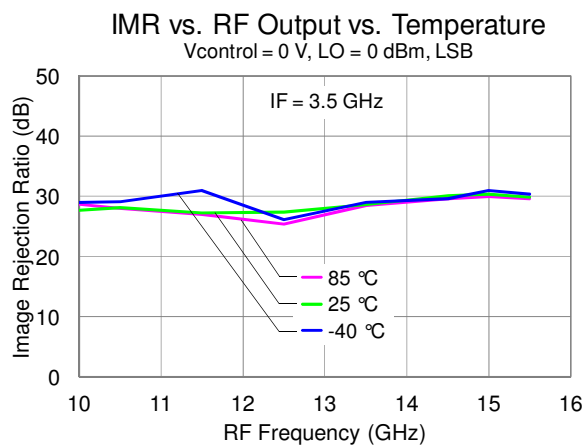
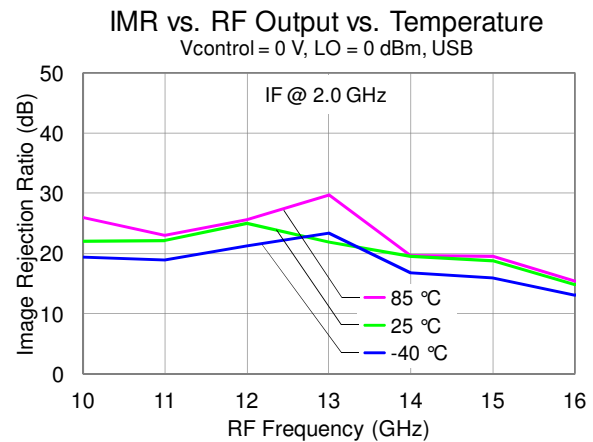
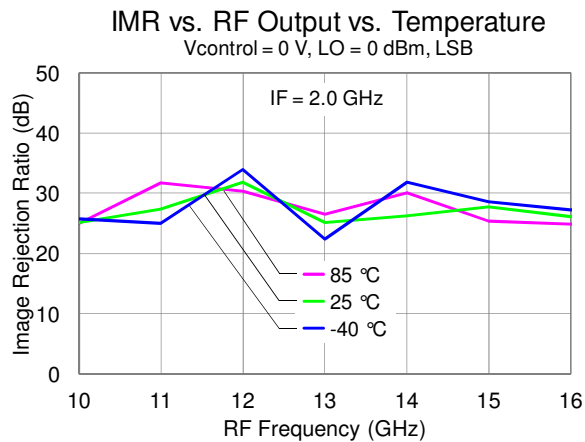
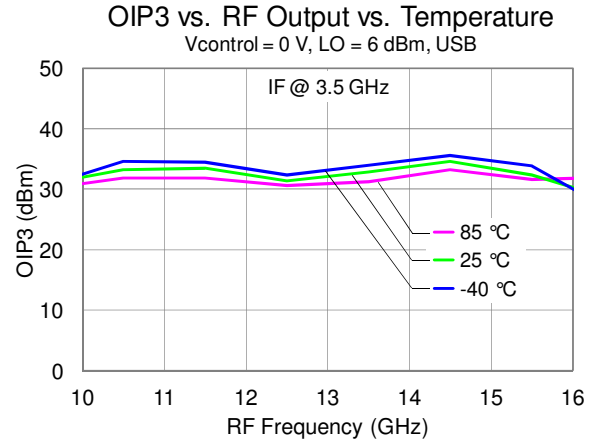
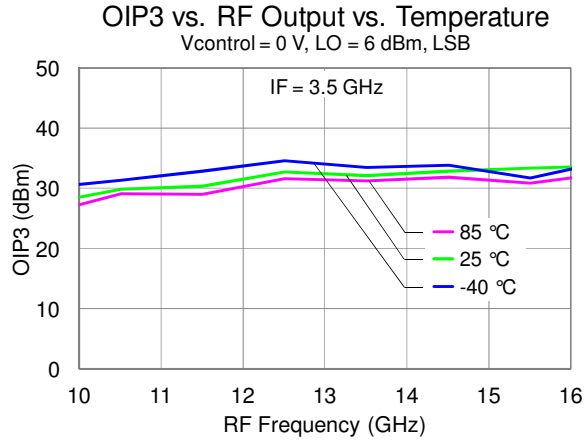

Typical Performance

IF Input Power = -10 dBm, VDLO = 5 V, IDLO = 60 mA, VDRF = 5 V, IDRF = 240 mA, VGX = -1.2 V, VREF = 2 V.
Data taken with external IF hybrid and LO nulling applied

M x N Spurious Outputs for LSB

LO = 0 – 6 dBm, 25 °C; All values are in dBc.

For LSB IF = 2.0 GHz: LO = 12.0 GHz to 18.0 GHz; IF = 3.5 GHz: LO = 13.5 GHz to 19.0 GHz.

RF/LO	0	1	2	3
-3	---	70	79	76
-2	---	44	40	75
-1	---	0	38	69
0	---	24	30	38
1	61	24	69	68
2	62	44	79	75
3	72	78	78	76

RF/LO	0	1	2	3
-3	---	84	75	73
-2	---	50	45	71
-1	---	0	59	63
0	---	21	28	34
1	51	27	64	69
2	49	64	74	74
3	85	77	70	---

M x N Spurious Outputs for USB

LO = 0 – 6 dBm, 25 °C; All values are in dBc.

For USB IF = 2.0 GHz: LO = 8.0 GHz to 14.0 GHz; IF = 3.5 GHz: LO = 6.5 GHz to 12.5 GHz.

RF/LO	0	1	2	3
-3	---	70	46	44
-2	---	46	29	54
-1	---	17	20	15
0	---	23	-17	25
1	56	0	8	26
2	28	33	32	62
3	48	43	66	71

RF/LO	0	1	2	3
-3	---	62	66	49
-2	---	70	33	41
-1	---	23	8	14
0	---	19	-29	-17
1	23	0	4	11
2	27	30	38	41
3	56	58	64	72

Pin Description

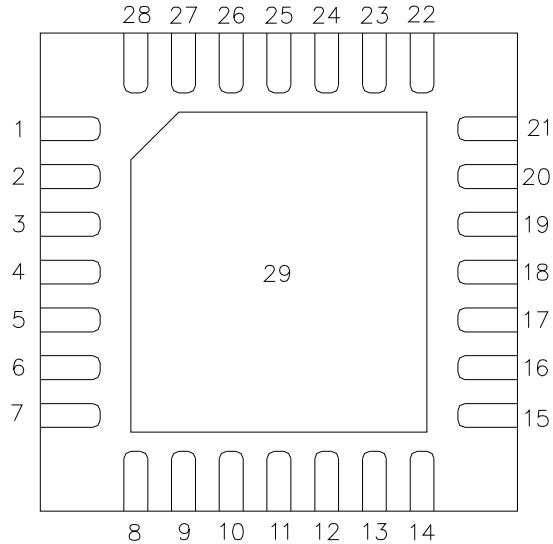

TOP VIEW

Pin	Symbol	Description
1, 7, 8, 9, 13, 14, 15, 16, 21, 22, 26, 28	GND	Internal Grounding; must be grounded on PCB.
2	RF OUT	RF Output matched to 50 ohms, AC Coupled.
3, 11, 18, 19, 20	NC	No internal connection; must be grounded on PCB.
4	VCTRL	Control Voltage. Bias network is required; see Application Circuit on page 17 as an example.
5	VREF	Reference Voltage. Bias network is required; see Application Circuit on page 17 as an example.
6	VGRF	RF Gate Voltage. Bias network is required; see Application Circuit on page 17 as an example.
10	IF1	IF Input matched to 50 ohms, DC coupled.
12	IF2	IF Input matched to 50 ohms, DC coupled.
17	LO IN	LO Input, matched to 50 ohms, AC coupled.
23	VGLO	LO Gate Voltage. Bias network is required; see Application Circuit on page 17 as an example.
24	VDLO	LO Drain Voltage. Bias network is required; see Application Circuit on page 17 as an example.
25	VGX	Mixer Voltage. Bias network is required; see Application Circuit on page 17 as an example.
27	VDRF	RF Drain Voltage. Bias network is required; see Application Circuit on page 17 as an example.
29	GND	Backside Paddle. Multiple vias should be employed to minimize inductance and thermal resistance; see Mounting Configuration on page 20 for suggested footprint.

Application Circuit

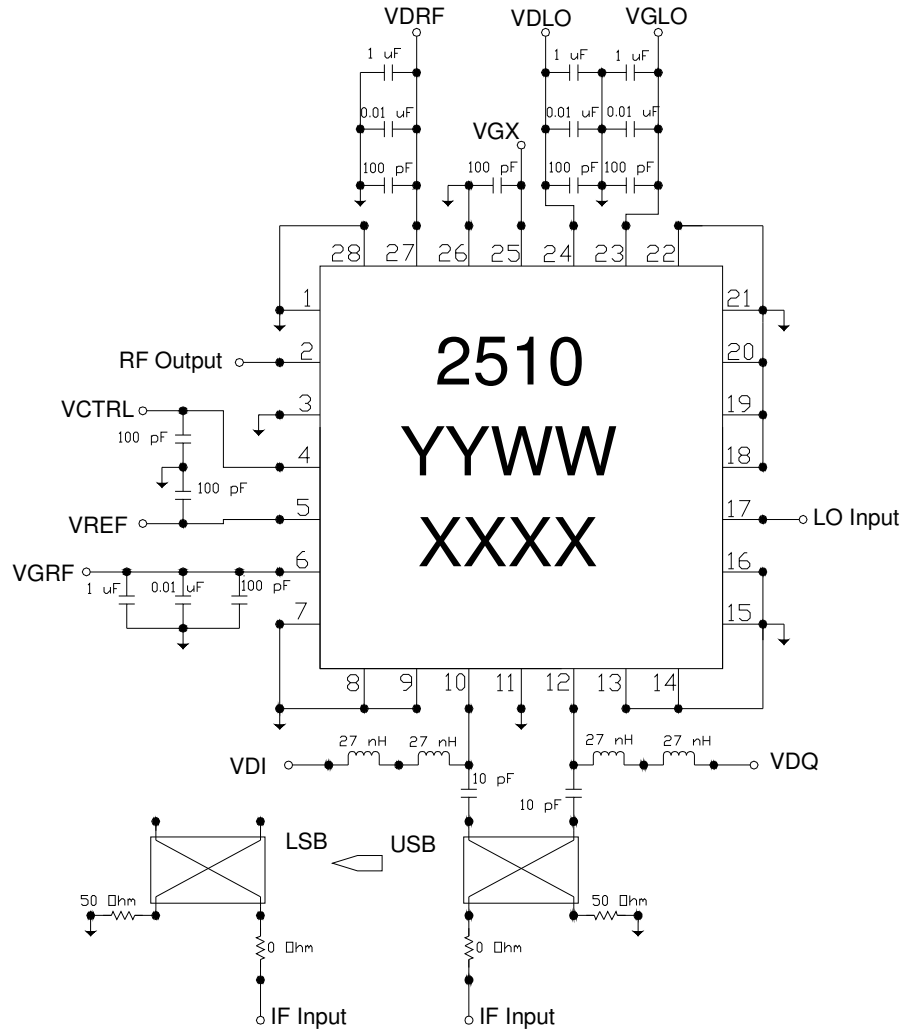

Biasing Procedures

Bias up

- Set VGX to -1.2 V
- Set VREF to 2.0 V
- Set VCTRL to 0 V
- Set VGLO to -1.5 V
- Set VDLO to 5.0 V
- Increase VGLO to get IDLO = 60 mA
- Set VGRF to -1.5 V
- Set VDRF to 5.0 V
- Increase VGRF to get IDRFB = 240 mA
- Set VDI, VDQ to 0 V; or no connection
- Apply RF signal

Bias Down

- Turn off RF signal
- Reduce VDLO to 0 V
- Reduce VDRF to 0 V
- Set VDI to 0 V, if used for LO nulling
- Set VDQ to 0 V, if used for LO nulling
- Reduce VGLO to 0 V
- Reduce VGRF to 0 V
- Reduce VREF to 0 V
- Reduce VCTRL to 0 V
- Reduce VGX to 0 V

Application Circuit

PC Board Layout

Board material is RO4003 0.008" thickness with 1/2 oz copper cladding.
 For further technical information, refer to the [TGC2510-SM](#) Product Information page.

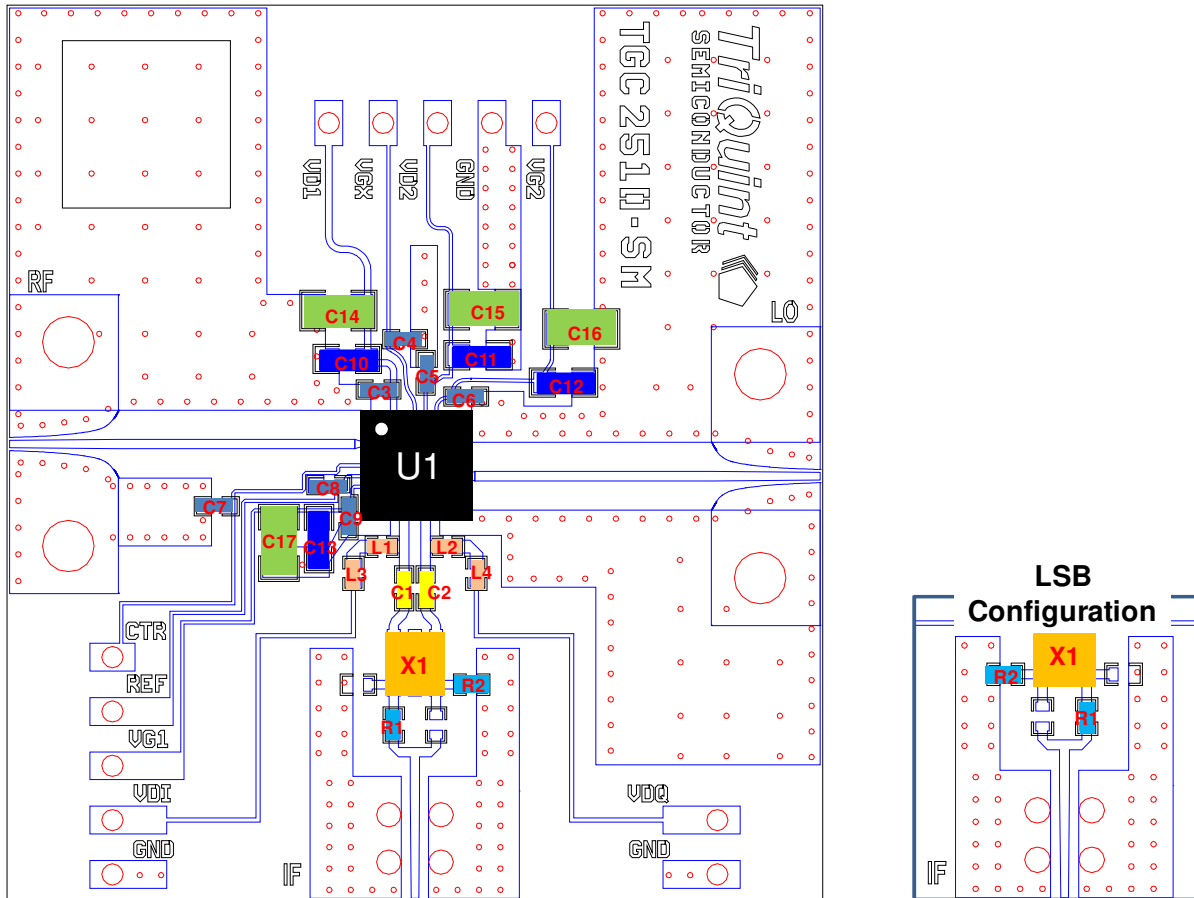

Bill of Material

Ref Des	Value	Description	Manufacturer	Part Number
C1 – C2	10 pF	Cap, 0402, 50V, 5%, NPO	various	
C3 – C9	100 pF	Cap, 0402, 50V, 5%, NPO	various	
C10 – C13	0.01 μF	Cap, 0805, 25V, 5%, COG	various	
C14 – C17	1 μF	Cap, 0805, 25V, 5%, X5R	various	
L1 – L4	27 nH	Ind, 0201, 100 mA, 5%, SMD	various	
R1	0 Ω	Res, 0402, 0.01W, SMD	various	
R2	50 Ω	Res, 0402, 0.05W, 0.1%, SMD	various	
X1		Power Splitter	Mini-Circuits	QCN-25+ or QCN45+
U1		Ku-Band Up-Converter	TriQuint	TGC2510-SM

Mechanical Information

Package Information and Dimensions

All dimensions are in millimeters.

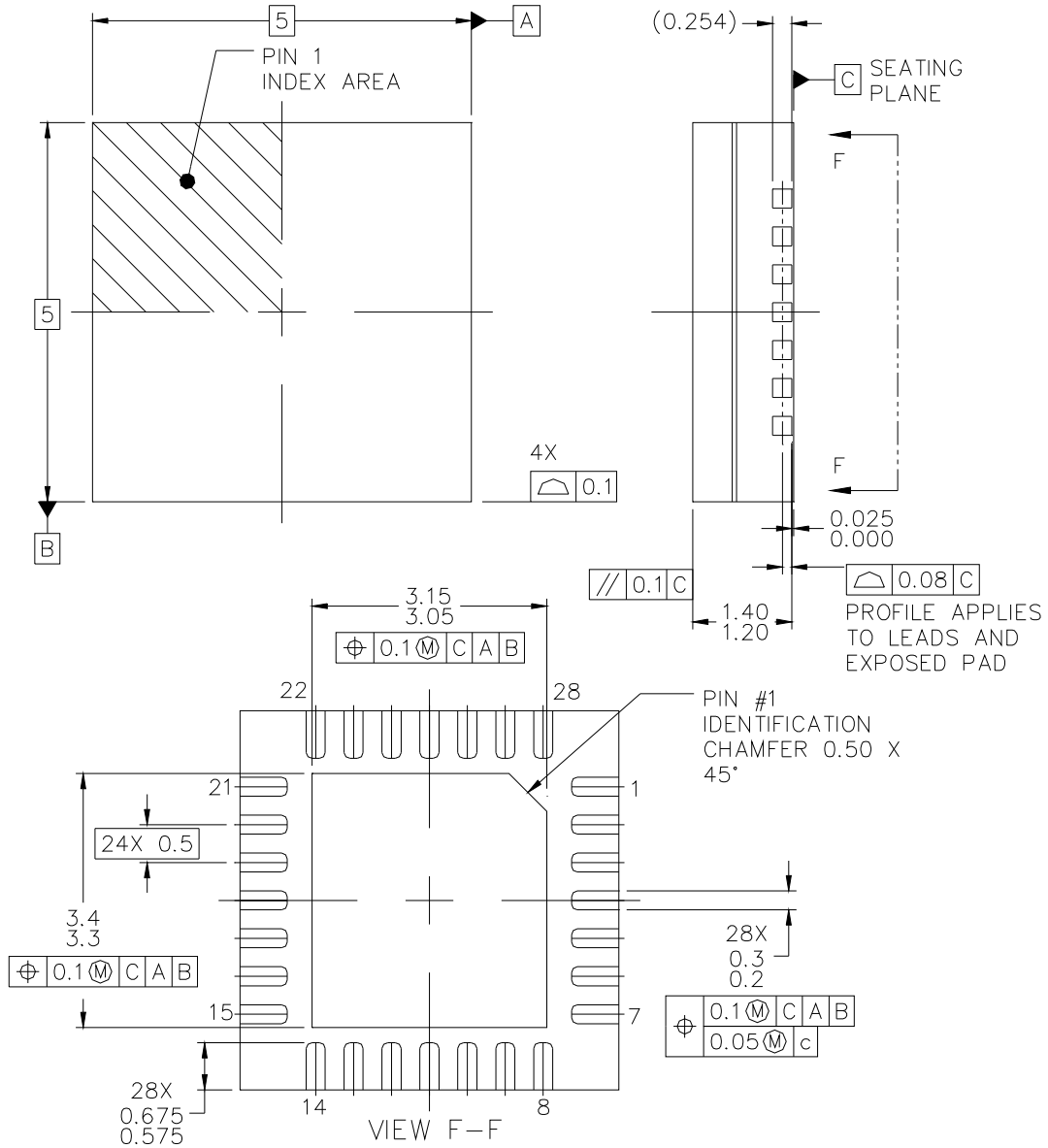

The TGC2510-SM will be marked with the “2510” designator and a lot code marked below the part designator. The “YY” represents the last two digits of the year the part was manufactured, the “WW” is the work week, and the “XXXX” is an auto-generated number.

This package is lead-free/RoHS-compliant with a copper alloy base (CDA194), and the plating material on the leads is NiPdAu. It is compatible with lead-free (maximum 260 °C reflow temperature) soldering processes.

Mechanical Information

PCB Mounting Pattern

All dimensions are in millimeters.

Notes:

1. The pad pattern shown has been developed and tested for optimized assembly at TriQuint Semiconductor. The PCB land pattern has been developed to accommodate lead and package tolerances. Since surface mount processes vary from company to company, careful process development is recommended.
2. Ground / thermal vias are critical for the proper performance of this device. Vias should use a .35mm diameter drill and have a final plated thru diameter of .25 mm.

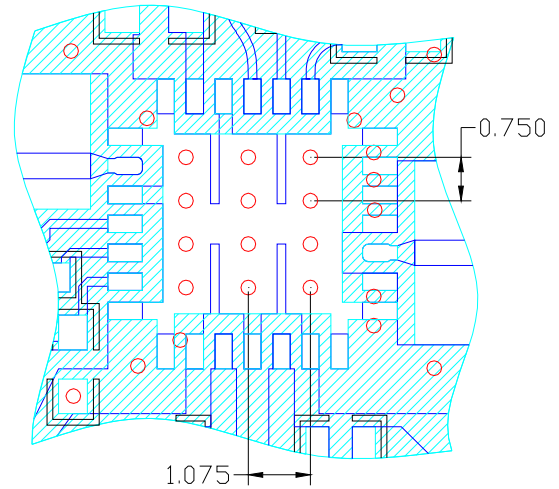

Tape and Reel Information

Tape and reel specifications for this part are also available on the TriQuint website in the “Application Notes” section.

Standard T/R size = 500 pieces on a 13” reel.

MATERIAL		CAVITY (mm)				DISTANCE BETWEEN CENTERLINE (mm)		CARRIER TAPE (mm)	COVER TAPE (mm)
Vendor	Vendor P/N	Length (A0)	Width (B0)	Depth (K0)	Pitch (P1)	Length direction (P2)	Width Direction (F)	Width (W)	Width (W)
Advantek	BCC5X5-B	5.25	5.25	1.8	8.0	2.00	5.50	12.0	9.20

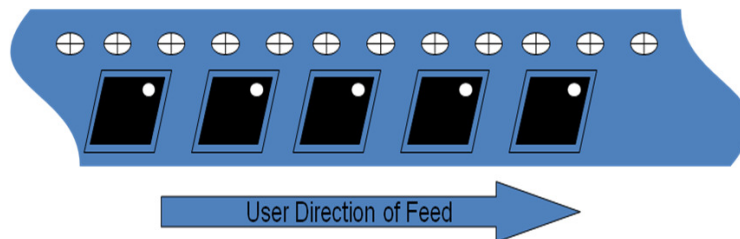
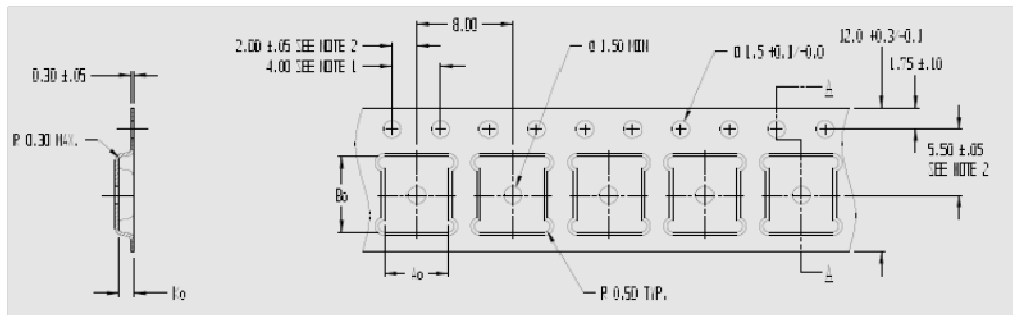

Product Compliance Information

ESD Information



Caution! ESD-Sensitive Device

ESD Rating: TBD
 Value: Passes \geq TBD V min.
 Test: Human Body Model (HBM)
 Standard: JEDEC Standard JESD22-A114

MSL Rating

Moisture Sensitivity Level (MSL) TBD at 260 °C convection reflow per JEDEC standard IPC/JEDEC J-STD-020.

Solderability

Compatible with lead-free soldering processes, 260 °C maximum reflow temperature.

Package lead plating: NiPdAu

The use of no-clean solder to avoid washing after soldering is recommended.

This package is not compatible with solder containing lead.

RoHS Compliance

This part is compliant with EU 2002/95/EC RoHS directive (Restrictions on the Use of Certain Hazardous Substances in Electrical and Electronic Equipment).

This product also has the following attributes:

- Lead Free
- Halogen Free (Chlorine, Bromine)
- Antimony Free
- TBBP-A (C₁₅H₁₂Br₄O₂) Free
- PFOS Free
- SVHC Free

Recommended Soldering Temperature Profile

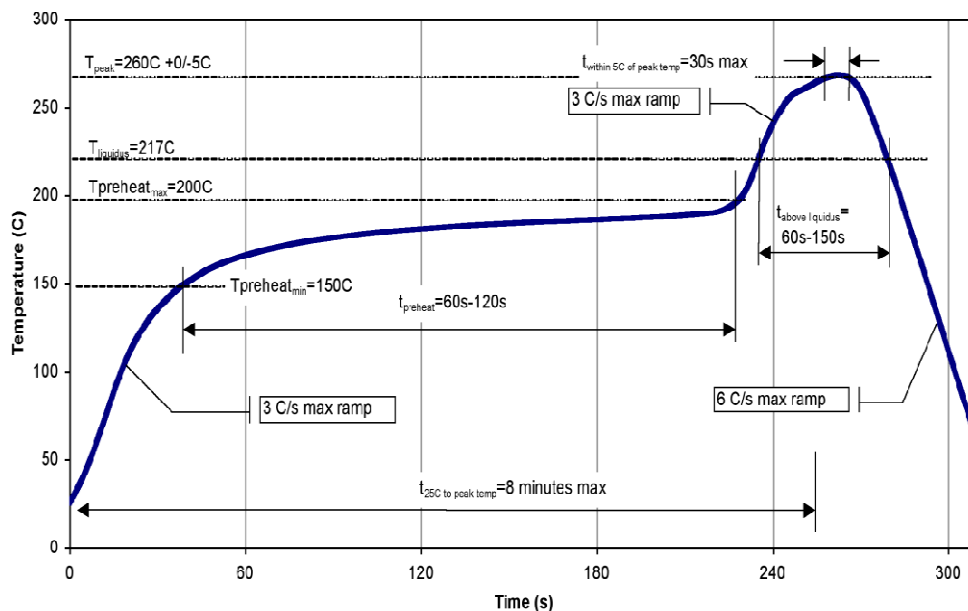

TGC2510-SM

Ku-Band Upconverter



Contact Information

For the latest specifications, additional product information, worldwide sales and distribution locations, and information about TriQuint:

Web: www.triquint.com
Email: info-sales@tqs.com

Tel: +1.972.994.8465
Fax: +1.972.994.8504

For technical questions and application information:

Email: info-networks@tqs.com

Important Notice

The information contained herein is believed to be reliable. TriQuint makes no warranties regarding the information contained herein. TriQuint assumes no responsibility or liability whatsoever for any of the information contained herein. TriQuint assumes no responsibility or liability whatsoever for the use of the information contained herein. The information contained herein is provided "AS IS, WHERE IS" and with all faults, and the entire risk associated with such information is entirely with the user. All information contained herein is subject to change without notice. Customers should obtain and verify the latest relevant information before placing orders for TriQuint products. The information contained herein or any use of such information does not grant, explicitly or implicitly, to any party any patent rights, licenses, or any other intellectual property rights, whether with regard to such information itself or anything described by such information.

TriQuint products are not warranted or authorized for use as critical components in medical, life-saving, or life-sustaining applications, or other applications where a failure would reasonably be expected to cause severe personal injury or death.