

# Cascadable Silicon Bipolar MMIC Amplifier

## Technical Data

**MSA-0185**

### Features

- **Cascadable 50 Ω Gain Block**
- **3 dB Bandwidth:**  
DC to 1.0 GHz
- **High Gain:**  
17.5 dB Typical at 0.5 GHz
- **Unconditionally Stable**  
( $k > 1$ )
- **Low Cost Plastic Package**

### Description

The MSA-0185 is a high performance silicon bipolar Monolithic Microwave Integrated Circuit (MMIC) housed in a low cost plastic package. This MMIC is

designed for use as a general purpose 50 Ω gain block. Typical applications include narrow and broad band IF and RF amplifiers in industrial and military applications.

The MSA-series is fabricated using HP's 10 GHz  $f_T$ , 25 GHz  $f_{MAX}$ , silicon bipolar MMIC process which uses nitride self-alignment, ion implantation, and gold metallization to achieve excellent performance, uniformity and reliability. The use of an external bias resistor for temperature and current stability also allows bias flexibility.

### 85 Plastic Package

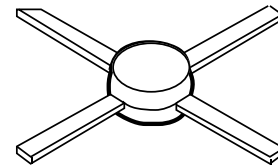

### Typical Biasing Configuration

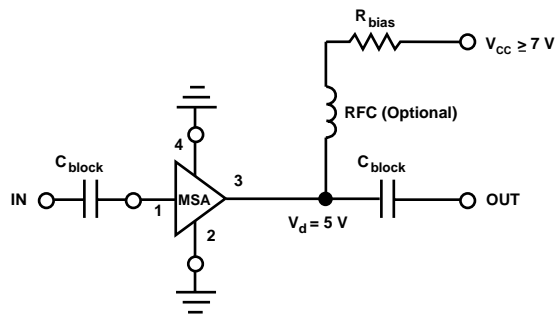

## MSA-0185 Absolute Maximum Ratings

Parameter	Absolute Maximum <sup>[1]</sup>
Device Current	40 mA
Power Dissipation <sup>[2,3]</sup>	200 mW
RF Input Power	+13 dBm
Junction Temperature	150°C
Storage Temperature	-65 to 150°C

**Thermal Resistance<sup>[2,4]</sup>:**

$$\theta_{jc} = 105^{\circ}\text{C/W}$$

### Notes:

1. Permanent damage may occur if any of these limits are exceeded.
2.  $T_{\text{CASE}} = 25^{\circ}\text{C}$ .
3. Derate at  $9.5 \text{ mW/}^{\circ}\text{C}$  for  $T_{\text{C}} > 129^{\circ}\text{C}$ .
4. See MEASUREMENTS section “Thermal Resistance” for more information.

## MSA-0185 Electrical Specifications<sup>[1]</sup>, $T_{\text{A}} = 25^{\circ}\text{C}$

Symbol	Parameters and Test Conditions: $I_{\text{d}} = 17 \text{ mA}$ , $Z_{\text{o}} = 50 \Omega$	Units	Min.	Typ.	Max.
$G_{\text{P}}$	Power Gain ( $ S_{21} ^2$ ) $f = 0.1 \text{ GHz}$ $f = 0.5 \text{ GHz}$	dB	16.0	18.5 17.5	
$\Delta G_{\text{P}}$	Gain Flatness $f = 0.1 \text{ to } 0.6 \text{ GHz}$	dB		$\pm 0.6$	
$f_{3 \text{ dB}}$	3 dB Bandwidth	GHz		1.0	
VSWR	Input VSWR $f = 0.1 \text{ to } 3.0 \text{ GHz}$			1.3:1	
	Output VSWR $f = 0.1 \text{ to } 3.0 \text{ GHz}$			1.3:1	
NF	50 $\Omega$ Noise Figure $f = 0.5 \text{ GHz}$	dB		5.5	
$P_{1 \text{ dB}}$	Output Power at 1 dB Gain Compression $f = 0.5 \text{ GHz}$	dBm		1.5	
$\text{IP}_3$	Third Order Intercept Point $f = 0.5 \text{ GHz}$	dBm		14.0	
$t_{\text{D}}$	Group Delay $f = 0.5 \text{ GHz}$	psec		150	
$V_{\text{d}}$	Device Voltage	V	4.0	5.0	6.0
$\text{dV/dT}$	Device Voltage Temperature Coefficient	mV/°C		-9.0	

### Note:

1. The recommended operating current range for this device is 13 to 25 mA. Typical performance as a function of current is on the following page.

### MSA-0185 Typical Scattering Parameters ( $Z_0 = 50 \Omega$ , $T_A = 25^\circ\text{C}$ , $I_d = 17 \text{ mA}$ )

Freq. GHz	$S_{11}$		$S_{21}$			$S_{12}$			$S_{22}$	
	Mag	Ang	dB	Mag	Ang	dB	Mag	Ang	Mag	Ang
0.1	.06	166	18.4	8.36	172	-22.6	.074	3	.07	-17
0.2	.06	149	18.3	8.20	165	-22.0	.079	8	.07	-28
0.3	.06	133	18.1	8.01	158	-22.2	.078	11	.08	-43
0.4	.06	120	17.8	7.78	151	-21.9	.080	14	.09	-56
0.5	.06	105	17.5	7.53	144	-21.4	.085	18	.09	-68
0.6	.06	94	17.2	7.23	138	-21.4	.085	19	.09	-75
0.8	.07	72	16.5	6.66	127	-20.7	.092	24	.10	-89
1.0	.07	49	15.7	6.09	116	-19.7	.104	27	.10	-100
1.5	.07	12	13.8	4.89	94	-18.0	.126	32	.11	-120
2.0	.04	-13	12.0	3.98	76	-16.2	.154	31	.11	-134
2.5	.03	-84	10.6	3.38	65	-15.1	.175	33	.11	-138
3.0	.07	-159	9.2	2.88	52	-14.2	.194	29	.09	-146
3.5	.12	-174	8.0	2.50	38	-13.3	.216	24	.08	-135
4.0	.16	170	6.8	2.19	26	-12.8	.229	19	.08	-120
4.5	.21	150	5.7	1.93	14	-12.3	.242	13	.08	-107
5.0	.25	126	4.7	1.72	3	-12.2	.245	-6	.07	-110

A model for this device is available in the DEVICE MODELS section.

### MSA-0185 Typical Performance, $T_A = 25^\circ\text{C}$

(unless otherwise noted)

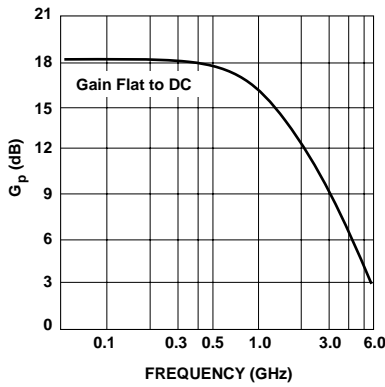

Figure 1. Typical Power Gain vs. Frequency,  $T_A = 25^\circ\text{C}$ ,  $I_d = 17 \text{ mA}$ .

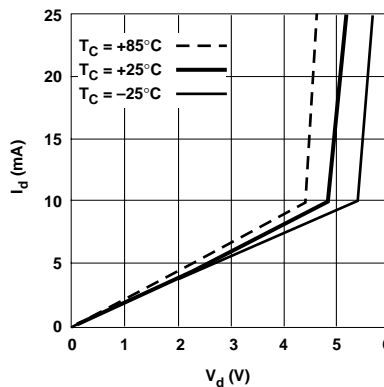

Figure 2. Device Current vs. Voltage.

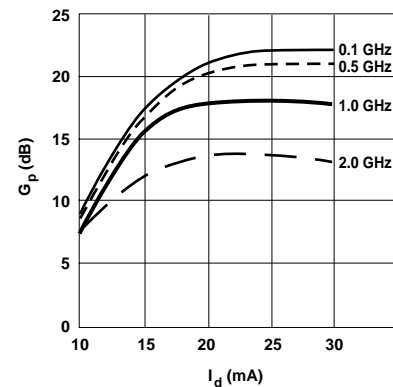

Figure 3. Power Gain vs. Current.

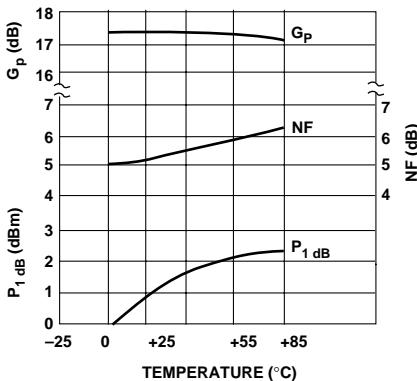

Figure 4. Output Power at 1 dB Gain Compression, NF and Power Gain vs. Case Temperature,  $f = 0.5 \text{ GHz}$ ,  $I_d = 17 \text{ mA}$ .

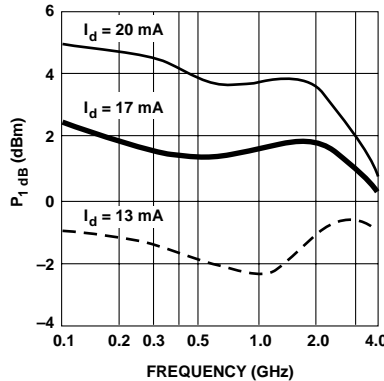

Figure 5. Output Power at 1 dB Gain Compression vs. Frequency.

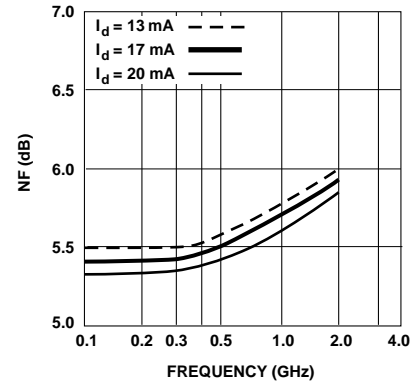

Figure 6. Noise Figure vs. Frequency.

## 85 Plastic Package Dimensions

