

# D10 Expert™ - Analog and Discrete Outputs



## Datasheet

Advanced Sensor for use with Plastic Fiber Optics

To view or download the latest technical information about this product, including specifications, dimensions, accessories, and wiring, see <http://www.bannerengineering.com>.

## Features

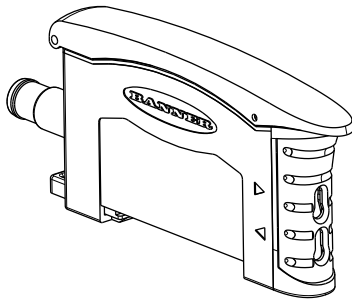

- Easy-to-set automatic *Expert*-style TEACH options\* including static, dynamic, and single-point programming plus manual adjustment for fine-tuning
- 16-bit microcontroller and 12-bit Analog-to-Digital converter for high-performance, low-contrast sensing
- Easy-to-read 4-digit display for TEACH and signal strength readout, plus indicators for a continuous readout of operating status (user configurable)
- Models available with one scalable Analog output (4 to 20 mA or 0 to 10V) and one Discrete output (PNP or NPN)
- Four-mode power and speed selection with automatic cross-talk avoidance circuitry
- Selectable OFF-delay options
- Gate input wire can be used to selectively inhibit sensor outputs from switching
- Models available with visible red (680 nm) or visible green (525 nm) sensing beam
- Models available with 2 m or 9 m (6.5 ft or 30 ft) cable or integral Pico-style quick-disconnect
- Sleek, ultra-slim 10 mm housing, mounts to a standard 35 mm DIN rail

\* U.S. Patent #5,808,296

## Models

Models		Cables <sup>1</sup>	Discrete Outputs	Analog Output
Red Beam	Green Beam			
D10INFP	D10INFPG	2 m (6.5 ft) Cable	NPN	4 to 20 mA
D10INFPQ	D10INFPGQ	6-pin Pico-style QD		
D10IPFP	D10IPFPG	2 m (6.5 ft) Cable	PNP	
D10IPFPQ	D10IPFPGQ	6-pin Pico-style QD		
D10UNFP	D10UNFPG	2 m (6.5 ft) Cable	NPN	0 to 10V
D10UNFPQ	D10UNFPGQ	6-pin Pico-style QD		
D10UPFP	D10UPFPG	2 m (6.5 ft) Cable	PNP	
D10UPFPQ	D10UPFPGQ	6-pin Pico-style QD		

<sup>1</sup> To order the 9 m (30 ft) cable model, add the suffix "W/30" to the cabled model number. For example, D10xFP W/30. Models with a quick disconnect require a mating cordset. See Accessories.



## Overview

The D10 *Expert* Sensor is a high-performance plastic fiber-optic sensor whose many configuration (TEACH-mode) options make it suitable for demanding applications. Even with all its features, it is extremely easy to use. Advanced 16-bit microcontroller technology makes this possible.

The D10 *Expert* provides high-performance sensing in low-contrast applications. *Expert* TEACH and setup options provide static, dynamic and single-point programming plus manual fine adjustment, remote programming and push button lockout. Its slender, stylized housing has a large digital display visible beneath a clear cover for easy programming and status monitoring during operation. The sensor mounts directly to standard 35 mm DIN rail or using the supplied mounting bracket.

The sensor features two outputs with independent setpoints: one of two analog choices, depending on model, and one discrete (NPN or PNP, also depending on model). Built-in crosstalk avoidance protocol provides trouble-free operation for multiple sensors in one area.

For emitter and receiver port locations, see [Installation](#) on page 13

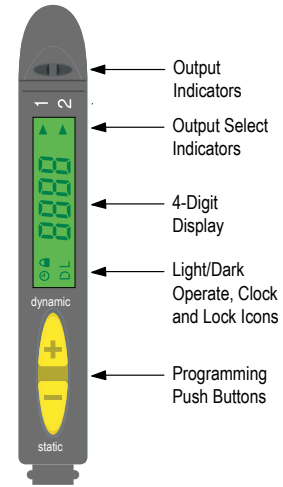

Figure 1. D10 Features

## Programming Options

Light/Dark Operate Selection	Toggle to select the condition for which each output will conduct: when the target is present or when the target is absent.								
OFF-Delay Timing Selection	Programmable OFF-delay pulse stretcher: 0, 2, 5, 10, 15, 20, 30, 40, 60, 80, or 100 ms Analog Outputs: OFF-delay acts as a smoothing function								
Display Selection	Discrete Output: Raw signal value or % excess signal Analog Output: Raw signal value or analog value (0 to 10V dc or 4 to 20 mA)								
Power Level/Speed Selection	Super High-Speed (SHS)	High-Speed (HS)		High-Power (HP)		Super High-Power (SHP)			
Response*	50 µs	200 µs		1 ms		2.5 ms			
Repeatability	25 µs	50 µs		75 µs		100 µs			
Max Range*	Fiber	Red 680 nm	Green 525 nm	Red 680 nm	Green 525 nm	Red 680 nm	Green 525 nm	Red 680 nm	Green 525 nm
	PI T16U	20 mm	9 mm	30 mm	9 mm	55 mm	13 mm	90 mm	16 mm
	PI T26U	100 mm	40 mm	150 mm	40 mm	250 mm	55 mm	400 mm	70 mm
	PI T46U	300 mm	100 mm	550 mm	100 mm	1000 mm	160 mm	1200 mm	180 mm
	PI T66U	600 mm	180 mm	1000 mm	180 mm	1700 mm	280 mm	2400 mm	320 mm
	PBT16U	6 mm	**	10 mm	**	18 mm	3 mm	30 mm	3.5 mm
	PBT26U	30 mm	12 mm	50 mm	12 mm	100 mm	20 mm	150 mm	25 mm
	PBT46U	100 mm	30 mm	175 mm	30 mm	250 mm	42 mm	300 mm	60 mm
PBT66U	175 mm	55 mm	250 mm	55 mm	400 mm	80 mm	475 mm	100 mm	
Tracking Feature	Sets Output 2 to identical settings as Output 1: Output 2 settings can then be revised as desired (see <a href="#">Advanced Setup</a> on page 11).								
Factory Default Settings	The following settings are preset at the factory: revert sensor to factory defaults using Advanced Setup procedure ( <a href="#">Advanced Setup</a> on page 11).								
	<ul style="list-style-type: none"> <li>Light operate (LO)</li> <li>No OFF-delay (t 0)</li> <li>Raw signal value (1234)</li> <li>Output 1 displayed</li> </ul>			<ul style="list-style-type: none"> <li>High Speed (HS): 200 µs response</li> <li>Maximum power setting</li> </ul>			<ul style="list-style-type: none"> <li>Analog: full scale</li> <li>Discrete: switchpoint positioned at middle of range</li> </ul>		

\* Diffuse mode performance based on 90% reflectance white test card.

\*\* ø0.010" bifurcated fiber not recommended in these speed settings. Contact Banner Applications for more information.

## Sensor Programming

Programming Procedures: Two push buttons, Dynamic (+) and Static (-), may be used to access and set programming parameters. For remote programming, connect a switch or digital input to the gray wire; length of the individual pulses is equal to the value T:

$$0.04 \text{ seconds} \leq T \leq 0.8 \text{ seconds}$$

Returning to RUN mode: TEACH and SETUP modes each may be exited in one of two ways: by exercising the 60-second time-out, or by cancelling out of the process. In TEACH mode, the sensor will return to RUN mode without saving any of the new settings; in SETUP mode, the sensor will return to RUN mode but save all of the settings. To cancel out of TEACH mode, press and hold the Static (-) button for 2 seconds; to cancel out of SETUP mode, press and hold both the Static (-) and Dynamic (+) buttons for 2 seconds.

Output 2: The setpoint(s) for each output can be set independently of one another. However, the functional range available for output 2 is dictated by the automatic power and gain settings established for output 1. Whenever output 1 is taught, output 2 also must be retaught. Applications hint: teach the weakest signal on output 1 first. Output 1 sets the emitter power. If only output 2 will be used, output 1 must be taught first. Or, enable tracking and teach only output 1, and then output 2 will be the same as output 1.

Dynamic TEACH and Adaptive Thresholds: Dynamic TEACH is used to program sensitivity during actual machine run conditions. During Dynamic TEACH, the sensor takes multiple samples of the light and dark conditions and automatically sets the sensitivity at the optimum level. For the discrete output, Dynamic TEACH activates the sensor's adaptive threshold system, which continuously tracks minimum and maximum signal levels, and automatically maintains centering of the switch point between the light and dark conditions. The adaptive threshold system remains in effect during RUN mode to automatically adjust for changes in the light or the dark conditions.

When Dynamic TEACH mode is used to program sensitivity, the output ON state (light or dark operate) will remain as it was last programmed. To change to either light or dark operate, use the SETUP mode (see [Sensor Setup](#) on page 10).

Sensitivity may be adjusted at any time when the sensor is in RUN mode by clicking the "+" and "-" buttons. However, when a manual adjustment is made, the adaptive threshold system is disabled (cancelled).

## Configuration Instructions

### Analog Outputs

Output 1 is configured for either 4 to 20 mA or 0 to 10V dc analog output, depending on the model. The sensor may be programmed using the two-point TEACH (either static or dynamic) or single-point window SET.

Two-point static or dynamic TEACH: The sensor sets the first taught condition to the highest output level (either 20 mA or 10V), and the second taught condition to the lowest level (either 4 mA or 0V), and scales between these points. If the first condition taught has more returned light, the sensor will be in Light Operate mode (LO). If the first taught condition is darker, the sensor will be in Dark Operate mode (DO). To change the slope of the analog output (refer to [Figure 2](#) on page 3), toggle LO/DO in [Sensor Setup](#) on page 10.

Single-point window SET: The sensor sets the taught condition to the mid-point of its range (12 mA or 5V, depending on the model). For Light Operate mode, the sensor will automatically scale up to 20 mA (or 10V) for maximum light condition (the maximum possible received signal) and down to 4 mA (or 0V) for maximum dark condition (no signal), and vice-versa for Dark Operate mode. To change the slope of the analog output (refer to [Figure 3](#) on page 3), toggle LO/DO in [Sensor Setup](#) on page 10.

An OFF-delay enabled for the analog output acts as an averaging function. During the OFF-delay period, the sensor will take multiple analog readings and average the result before changing the analog value. This acts to reduce the effects of major spikes in the analog system, in effect "smoothing" the output reading.



NOTE: Depending on the application configuration and fibers used, the analog function may or may not behave linearly. The received light intensity will be dictated by the inverse square properties of light.

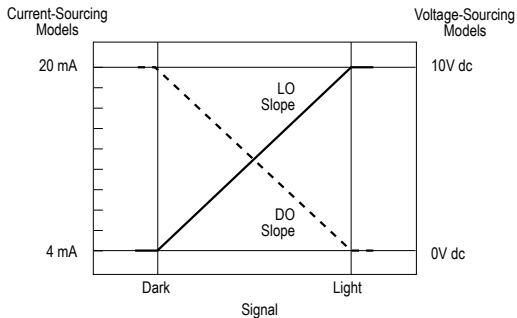

Figure 2. Analog output as a function of target position – two-point static or dynamic TEACH

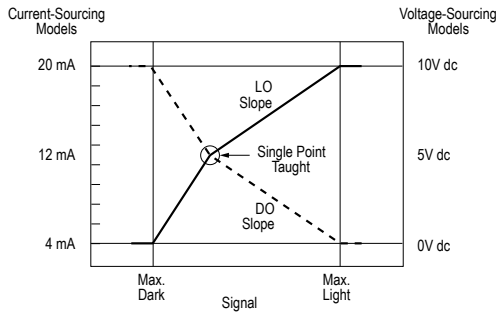
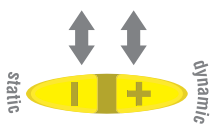
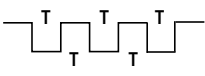
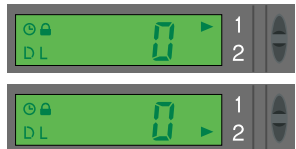

Figure 3. Analog output as a function of target position – window SET

### Active Channel Select

- Selects which channel to teach
- Displays channel configuration information.

Push Button	Remote 0.04 sec. ≤ T ≤ 0.8 sec.	Result
Single-click both buttons simultaneously. 	Triple-pulse the remote line.* 	Pointer icon: moves to the other channel indicator. 



\* Note: Triple-pulse will change the display, but will not save. To save Channel Select, make an adjustment to that channel as a TEACH, SET, or Sensor Setup.

## Two-Point Static TEACH (Threshold)

- Establishes a single switching threshold
- Threshold position is adjustable using “+” and “-” buttons (see [Manual Adjust](#) on page 9)

Static TEACH is the traditional setup method, used when two conditions can be presented by the user. The sensor locates a single sensing threshold (the switchpoint) midway between the two taught conditions, with the Output ON condition on one side, and the Output OFF condition on the other.

The first condition taught is the ON condition. The Output ON and OFF conditions can be reversed by changing Light/Dark Operate status in Setup mode (see [Sensor Setup](#) on page 10 ).

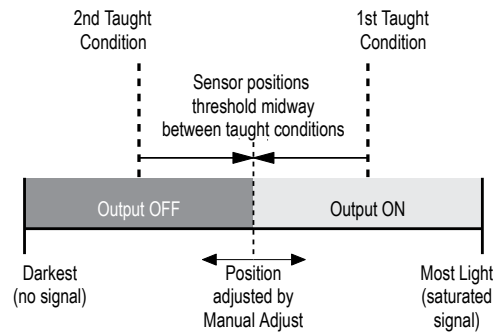

Figure 4. Static TEACH (Light Operate shown)



Static TEACH and Manual Adjust. Discrete output: Using Manual Adjust with Static TEACH moves the switching threshold.

Analog output: Using Manual Adjust with Static TEACH moves the entire span up (+) or down (-).

Contrast Values	
500+	Excellent: Very stable operation.
100-500	Good: Minor sensing variables will not affect sensing reliability.
32-99	Low: Minor sensing variables may affect sensing reliability.
0-31	Marginal: Consider an alternate sensing scheme.

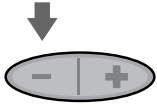
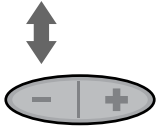

Figure 5. Contrast Values

1. Access the Static TEACH Mode.



Method	Action	Result
Push Button	Press and hold the Static (-) button > 2 seconds. 	<ul style="list-style-type: none"> <li>• Display flashes “1St”</li> <li>• Arrow icon turns red</li> </ul> 
Remote Input <sup>2</sup>	No action is required; the sensor is automatically ready for the 1st TEACH condition	

2. TEACH the Output ON condition.

<sup>2</sup> 0.04 seconds ≤ T ≤ 0.8 seconds

Method	Action	Result
Push Button	a. Present the Output ON condition b. Click the Static button	 Display flashes "2nd" 
Remote Input	a. Present the Output ON condition b. Single-pulse the remote line	

1. TEACH the Output OFF condition.

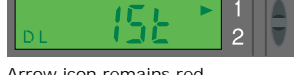
Method	Action	Result
Push Button	a. Present the Output OFF condition b. Click the Static button	TEACH conditions accepted <ul style="list-style-type: none"> <li>• Display flashes "PASS," followed by a number (denoting contrast); see <a href="#">Figure 5</a> on page 4.</li> </ul>  <ul style="list-style-type: none"> <li>• Sensor returns to RUN mode with new settings</li> <li>• Arrow icon turns green</li> </ul>
Remote Input <sup>3</sup>	a. Present the Output OFF condition b. Single-pulse the remote line	TEACH conditions unacceptable <ul style="list-style-type: none"> <li>• Display flashes "FAIL" and returns to "1St"</li> </ul>   <ul style="list-style-type: none"> <li>• Arrow icon remains red</li> <li>• After 60 seconds, sensor returns to RUN mode (Arrow icon turns green) without changing settings</li> </ul>

### Dynamic TEACH and Adaptive Thresholds

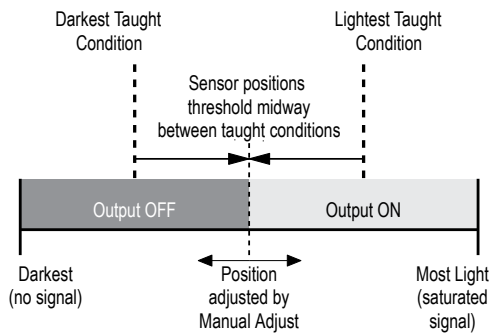

Figure 6. Dynamic TEACH (Light Operate shown)

- TEACH on-the-fly
- Sets a single threshold
- Threshold position is adjustable using the "+" and "-" buttons (see [Manual Adjust](#) on page 9)

Dynamic TEACH is used to program sensitivity during actual machine run conditions. During Dynamic TEACH, the sensor takes multiple samples of the light and dark conditions and automatically sets the sensitivity at the optimum level. Dynamic TEACH activates the sensor's adaptive threshold system, which continuously tracks minimum and maximum signal levels, and automatically maintains centering of the switch point between the light and dark conditions. The adaptive threshold system remains in effect during RUN mode to automatically adjust for changes in the light or the dark conditions.

When Dynamic TEACH mode is used to program sensitivity, the output ON state (light or dark operate) will remain as it was last programmed. To change to either light or dark operate, use the SETUP mode (see [Sensor Setup](#) on page 10).







#### Dynamic TEACH and Manual Adjust

Sensitivity may be adjusted at any time when the sensor is in RUN mode by clicking the "+" and "-" buttons. However, when a manual adjustment is made, the adaptive threshold system is disabled (cancelled).

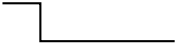
Contrast Values	
500+	Excellent: Very stable operation.
100-500	Good: Minor sensing variables will not affect sensing reliability.
32-99	Low: Minor sensing variables may affect sensing reliability.
0-31	Marginal: Consider an alternate sensing scheme.

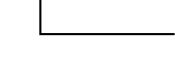
Figure 7. Dynamic Contrast Values

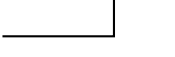
<sup>3</sup> 0.04 seconds ≤ T ≤ 0.8 seconds

	Push Button	Remote 0.04 sec. ≤ T ≤ 0.8 sec.	Result
Access Dynamic TEACH Mode	Press and hold Dynamic (+) button. 	Hold remote line low (to ground). 	<ul style="list-style-type: none"> <li>• Display flashes "dYn"</li> <li>• Arrow icon turns red</li> </ul> 
TEACH Sensing Conditions	Present Output ON/OFF conditions while continuing to hold Dynamic button. 	Present Output ON/OFF conditions while continuing to hold remote line low (to ground). 	
Return to RUN Mode	Release Dynamic button. 	Release remote line/switch. 	<p>TEACH conditions accepted</p> <ul style="list-style-type: none"> <li>• Display flashes "PASS," followed by a number (denoting contrast); see <a href="#">Figure 7</a> on page 5</li> <li>• Sensor returns to RUN mode with new settings</li> <li>• Arrow icon turns green</li> </ul>  <p>TEACH conditions unacceptable</p> <ul style="list-style-type: none"> <li>• Display flashes "FAIL"</li> <li>• Arrow icon remains red</li> <li>• Sensor returns to RUN mode (Arrow icon turns green) without changing settings</li> </ul> 

### Single-Point Window Set

- Sets a single ON condition that extends 200 counts above and below the taught condition (including ±100 counts hysteresis)
- All other conditions (lighter or darker) result in OFF output
- Sensing window size (sensitivity) is adjustable using "+" and "-" buttons (see [Manual Adjust](#) on page 9)

Window Set is most useful when a product may not always appear in the same place, or when other signals may appear. Window Set designates a sensing window, with the Output ON condition inside the window, and the Output OFF conditions outside the window. The sensor accepts a single sensing condition, and adds switching thresholds and hysteresis above and below that condition to create a sensing window. Output ON and OFF conditions can be reversed by changing Light/Dark Operate status in Setup mode.

#### Window Set and Manual Adjust

Discrete: Using Manual Adjust with Window Set expands or contracts the size of the window.

Analog: Analog manual adjust increases (+) or decreases (-) counts on both ends by the same amount, but it does not rescale. Cycling the power will rescale the window and adjustments.

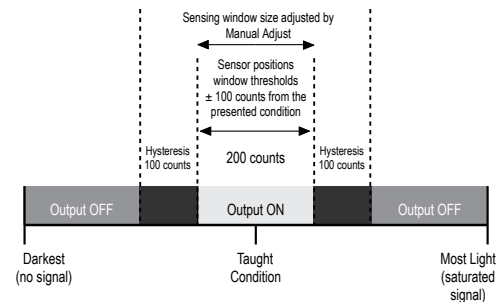









Figure 8. Single-Point Window SET and Hysteresis (Light Operate shown)

#### 1. Access the SET Mode.

Method	Action	Result
Push Button	Press and hold the Static (-) button > 2 seconds 	<ul style="list-style-type: none"> <li>• Display flashes "1St"</li> </ul>  <ul style="list-style-type: none"> <li>• Arrow icon turns red</li> </ul>
Remote Input <sup>4</sup>	<ol style="list-style-type: none"> <li>Present the sensing condition</li> <li>Single-pulse the remote line</li> </ol> 	<ul style="list-style-type: none"> <li>• Display flashes "2nd"</li> </ul>  <ul style="list-style-type: none"> <li>• Arrow icon turns red</li> </ul>

<sup>4</sup> 0.04 seconds ≤ T ≤ 0.8 seconds

2. SET the sensing condition.

Method	Action	Result
Push Button	a. Present the sensing condition b. Double-click the Static button	TEACH conditions accepted <ul style="list-style-type: none"> <li>Display flashes "Sn6L," then "Pt" twice</li> </ul>   <ul style="list-style-type: none"> <li>Sensor returns to RUN mode with new settings</li> <li>Arrow icon turns green</li> </ul> TEACH conditions unacceptable <ul style="list-style-type: none"> <li>Display flashes "FAIL" and returns to "1St"</li> </ul>   <ul style="list-style-type: none"> <li>Arrow icon remains red</li> <li>After 60 seconds, the sensor returns to RUN mode (Arrow icon turns green) without changing settings</li> </ul>
Remote Input	Double-pulse the remote line	

Single-Point Light Set - Discrete Only

- Sets a threshold slightly below the taught condition.
- Any condition darker than the threshold condition causes the output to change state
- Threshold position is adjustable using the "+" and "-" buttons (see [Manual Adjust](#) on page 9)
- Recommended for applications where only one condition is known, for example a stable light background with varying darker targets

A single sensing condition is presented, and the sensor positions a threshold slightly below the presented condition. When a condition darker than the threshold is sensed, the output either turns ON or OFF, depending on the Light/Dark Operate setting (see [Sensor Setup](#) on page 10).

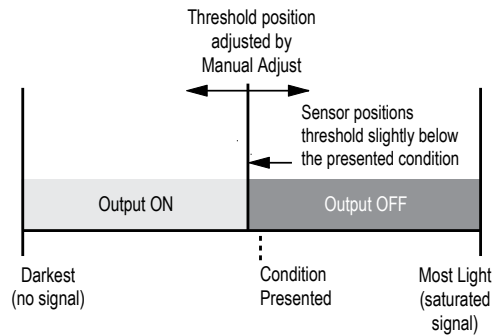

Figure 9. Single-Point Light Set (Light Operate shown)





Light SET and Light/Dark Operate Selection

Light Set teaches the Output OFF condition and forces the sensor into Dark Operate (DO) mode. The sensor can be reconfigured to Light Operate (LO) mode after the condition has been taught (see [Sensor Setup](#) on page 10).



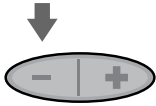

Mode	Threshold Offset (counts below taught signal value)
Super High-Speed	30
High-Speed	22
High-Power	9
Super High-Power	6

Figure 10. Light Set Threshold Offset

1. Access the SET Mode.

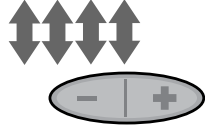
Method	Action	Result
Push Button	Press and hold the Static (-) button > 2 seconds 	<ul style="list-style-type: none"> <li>Display flashes "1St"</li> <li>Arrow icon turns red</li> </ul> 
Remote Input <sup>5</sup>	Single-pulse the remote line 	<ul style="list-style-type: none"> <li>Display flashes "2nd"</li> <li>Arrow icon turns red</li> </ul> 

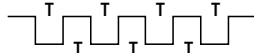
2. SET the Output OFF condition.

Method	Action	Result
Push Button	a. Present the Output OFF condition b. Four-click the Static button 	Threshold condition accepted <ul style="list-style-type: none"> <li>Display flashes "Sn6L," then "Lt" twice</li> </ul>   <ul style="list-style-type: none"> <li>Sensor returns to RUN mode with new settings</li> <li>Arrow icon turns green</li> </ul>
Remote Input	a. Present the Output OFF condition b. Four-pulse the remote line 	Threshold conditions unacceptable <ul style="list-style-type: none"> <li>Display flashes "FAIL" and returns to "1St"</li> </ul>   <ul style="list-style-type: none"> <li>Arrow icon remains red</li> <li>After 60 seconds, the sensor returns to RUN mode (the Arrow icon turns green) without changing settings</li> </ul>

### Single-Point Dark Set - Discrete Only

- Sets a threshold slightly above the taught condition
- Any condition lighter than the threshold condition causes the output to change state
- Threshold position is adjustable using the "+" and "-" buttons (see [Manual Adjust](#) on page 9)
- Recommended for applications where only one condition is known, for example a stable dark background with varying lighter targets

A single sensing condition is presented, and the sensor positions a threshold slightly above the taught condition. When a condition lighter than the threshold is sensed, the output either turns ON or OFF, depending on the Light/Dark Operate setting (see [Sensor Setup](#) on page 10).

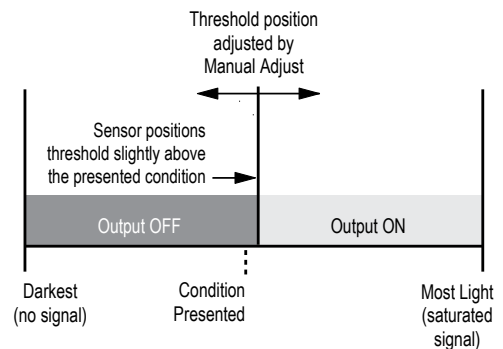

Figure 11. Single-Point Dark Set (Light Operate shown)

### Dark Set and Light/Dark Operate Selection

Dark Set teaches the Output OFF condition and forces the sensor into Light Operate (LO) mode. The sensor can be reconfigured to Dark Operate (DO) mode after the condition has been taught (see [Sensor Setup](#) on page 10).





<sup>5</sup> 0.04 seconds ≤ T ≤ 0.8 seconds





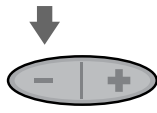

Mode	Threshold Offset (counts above taught signal value)
Super High-Speed	30
High-Speed	22
High-Power	9
Super High-Power	6

Figure 12. Dark Set Threshold Offset

1. Access the Set Mode.

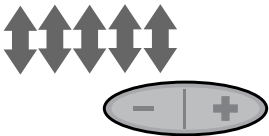
Method	Action	Result
Push Button	Press and hold the Static button > 2 seconds 	<ul style="list-style-type: none"> <li>Display flashes "1St"</li> <li>Arrow icon turns red</li> </ul> 
Remote Input <sup>6</sup>	Single-pulse the remote line 	<ul style="list-style-type: none"> <li>Display flashes "2nd"</li> <li>Arrow icon turns red</li> </ul> 

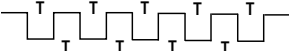
2. Set the Output OFF condition.

Method	Action	Result
Push Button	a. Present the Output OFF condition b. Five-click the Static button 	<b>Threshold Condition Accepted</b> <ul style="list-style-type: none"> <li>Display flashes "Sn6L," then "dr"</li> </ul>   <ul style="list-style-type: none"> <li>Sensor returns to RUN mode with new settings</li> <li>Arrow icon turns green</li> </ul>
Remote Input	a. Present the Output OFF condition b. Five-pulse the remote line 	<b>Threshold Condition Unacceptable</b> <ul style="list-style-type: none"> <li>Display flashes "FAIL" and returns to "1St"</li> </ul>   <ul style="list-style-type: none"> <li>Arrow icon remains red</li> <li>After 60 seconds, the sensor returns to RUN mode (the Arrow icon turns green) without changing settings</li> </ul>

### Manual Adjust

Manual Adjust is used during Run mode and is accomplished using the push buttons only. Its behavior depends on whether a switching threshold or a sensing window is used.





Switching Threshold:

- Fine-tunes sensing sensitivity
- Press "+" to increase; press "-" to decrease

Sensing Window:

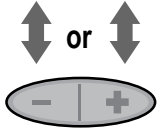





- Adjusts sensing window size (tolerance) for the single-point target condition
- Press "+" to increase; press "-" to decrease

<sup>6</sup> 0.04 seconds ≤ T ≤ 0.8 seconds

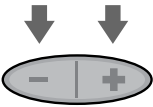
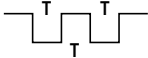
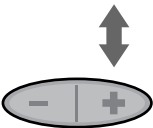
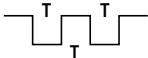

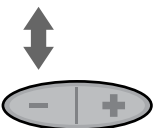

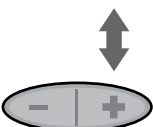
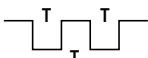

Method	Action	Result
Push Button	Click "+" to increase, or click "-" to decrease.  	Display briefly flashes the threshold setpoint value as it is being changed   OR Display flashes "inc" or "dec" as the window size is adjusted  or 
Remote Input <sup>7</sup>	Not available with remote programming	n/a



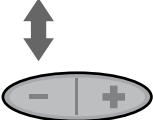

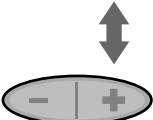
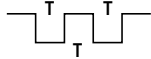
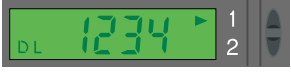

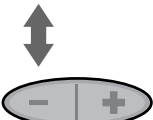
### Sensor Setup

- Configures sensor display and operating parameters
- Changes are updated instantly
- Click Dynamic (+) or double-pulse remote line to select an option
- Click Static (-) or single-pulse remote line to advance

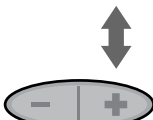
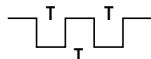
	Push Button	Remote 0.04 seconds ≤ T ≤ 0.8 seconds	Result
Access SETUP Mode	Press and hold both buttons concurrently for > 2 seconds. 	Double-pulse the remote line. 	Indicator Arrow Icon 1 ON Red
Select Light/Dark Operate	Click Dynamic (+) to toggle between selections. 	Double-pulse remote line to toggle between selections. 	Light Operate • Display flashes "lo" • L icon Dark Operate • Display flashes "do" • D icon  
	Click Static (-) to save selection and advance to "OFF-Delay." 	Single-pulse remote line to save selection and advance to "OFF-Delay." 	
Select OFF-Delay Timing Enable	Click Dynamic (+) to toggle between selections. 	Double-pulse remote line to toggle between selections. 	Off (No OFF-Delay) • "t 0" • Clock icon OFF 

<sup>7</sup> 0.04 seconds ≤ T ≤ 0.8 seconds

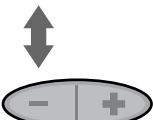
	Push Button	Remote 0.04 seconds ≤ T ≤ 0.8 seconds	Result
	<p>Click Static (-) to save selection and advance to "Display."</p> 	<p>Single-pulse remote line to save selection and advance to "Display."</p> 	<p>2 to 100 ms OFF-Delay</p>  <ul style="list-style-type: none"> <li>• "t 2," "t 5," "t 10," "t 15," "t 20," "t 30," "t 40," "t 60," "t 80," or "t100"</li> <li>• Clock icon ON</li> </ul>
Select Display Parameters	<p>Click Dynamic (+) to toggle between selections.</p> 	<p>Double-pulse remote line to toggle between selections.</p> 	<p>Raw Signal Value Discrete: "1234"</p>  <p>Analog: 4 -20, 0-10, A = mA, V = Volts</p> <p>Percent of excess signal Discrete: "123P"</p> 
	<p>Click Static (-) to save selection and advance to "Power/Speed."</p> 	<p>Single-pulse remote line to save selection and advance to "Power/Speed."</p> 	

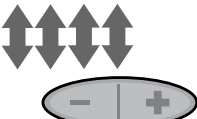
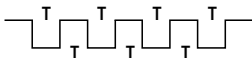

	Push Button	Remote 0.04 seconds ≤ T ≤ 0.8 seconds	Result
Select Speed and Power Combination	<p>Click Dynamic (+) to toggle between selections.</p> 	<p>Double pulse the remote line to toggle between selections.</p> 	<p>Indicator Arrow Icons 1 and 2 ON Red</p> <p>Super-high-speed (50-µs response) "SHS" (Complementary outputs; see note below)</p>  <p>High-speed (200-µs response) "HS"</p>  <p>High-power (1-ms response) "HP"</p>  <p>Super-high-power (2.5-ms response) "SHP"</p> 
	<p>Return to RUN mode.</p> <p>OR</p> <p>Click Static (-) to save selection and return to RUN mode.</p> 	<p>Single-pulse the remote line to save selection and return to RUN mode.</p> 	
	<p>Proceed to Advanced Setup.</p> <p>Quad-click Static (-) to proceed to Advanced Setup.</p> 	<p>Quad-pulse the remote line to proceed to Advanced Setup.</p> 	<p>See <a href="#">Advanced Setup</a> on page 11.</p>







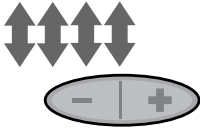
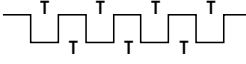



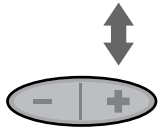
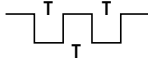

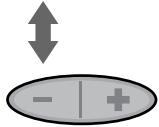

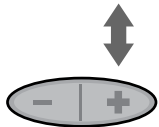
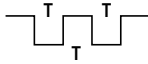
**Super-High-Speed Operation Note:** Under most conditions, the sensor's two discrete outputs operate independently. However, the outputs become complementary when operating at Super-High-Speed, due to its extremely fast response time. Only channel 1 is taught/adjusted; channel 2 is complementary to it (output 1 conducts for the taught ON condition, and output 2 conducts for the OFF state). To invert these conditions (output 1 – OFF condition, output 2 – ON), change light/dark operate setting.

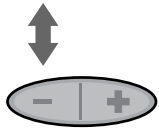
### Advanced Setup

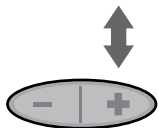
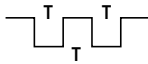

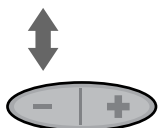
- Advanced adjustments to previously configured sensor display and operating parameters
- Quad-click Static (-) or quad-pulse remote line before exiting "Power and Speed" settings to enter this mode
- Click Dynamic (+) or double-pulse remote line to select an option
- Click Static or single-pulse remote line to advance
- Changes are updated instantly

	Push Button	Remote (0.04 s ≤ T ≤ 0.8 s)	Result
Enter SETUP Mode	<p>From "Power and Speed" mode, quad-click the Static (-) button.</p> 	<p>From "Power and Speed" mode, quad-pulse the remote line.</p> 	<ul style="list-style-type: none"> <li>Indicator Arrow Icons 1 and 2 remain red</li> <li>Display shows "Tracking Enabled" option</li> </ul> 

	Push Button	Remote (0.04 s ≤ T ≤ 0.8 s)	Result
Track Enable	<p>Click Dynamic (+) to toggle between selections.</p> 	<p>Double-pulse the remote line to toggle between selections.</p> 	<p>Sets output 2 identical to output 1</p> <p>Tracking Disabled Display shows "tr n"</p> 
	<p>Click Static (-) to save selection and advance to "Factory Default."</p> 	<p>Single-pulse the remote line to save selection and advance to "Factory Default."</p> 	<p>Tracking Enabled Display shows "tr Y"</p> 
Factory Default Settings	<p>Click Dynamic (+) to toggle between selections.</p> 	<p>Double-pulse the remote line to toggle between selections.</p> 	<p>Returns to factory default factory settings</p> <p>Factory Default Settings Not Selected Display shows "Fd n"</p> 
	<p>Click Static (-) to save selection and advance to "Display Orientation."</p> 	<p>Single-pulse the remote line to save selection and advance to "Display Orientation."</p> 	<p>Factory Default Settings Selected Display shows "Fd Y"</p> 
Display Orientation	<p>Click Dynamic (+) to toggle between selections.</p> 	<p>Double-pulse the remote line to toggle between selections.</p> 	<p>Inverts display to read "upside-down"</p> <p>Normal For example: 1234</p> <p>Inverted For example: 1234</p>  
	<p>Click Static (-) to return to RUN mode.</p> 	<p>Single-pulse the remote line to return to RUN mode.</p> 	<p> NOTE: Icons do not invert.</p>

### Push Button Lockout

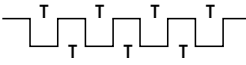
- Prevents unwanted adjustments or tampering of the push buttons
- Push buttons can be enabled or disabled only from the remote line and only during normal RUN mode

	Push Button	Remote (0.04 seconds ≤ T ≤ 0.8 seconds)	Result
Enable or Disable Push Buttons	Not available with push-button programming.	From RUN mode, quad-pulse the remote line to toggle between selections. 	<div style="display: flex; flex-direction: column; gap: 10px;"> <div> <p>Push buttons Disabled</p> <ul style="list-style-type: none"> <li>• Display flashes "loc"</li> <li>• Padlock icon appears</li> <li>• Sensor remains in RUN mode</li> </ul>  </div> <div> <p>Push Buttons Enabled</p> <ul style="list-style-type: none"> <li>• Display flashes "uloc"</li> <li>• Padlock icon disappears</li> <li>• Sensor remains in RUN mode</li> </ul>  </div> </div>

### Self-Diagnostic Error Modes

In the unlikely event that the setup parameters are lost or become corrupt, the display will continuously scroll: "USEr PSF Error." Reteach the sensor to recover. If the problem persists, contact your Banner representative for further information.

### Gate Input

The pink wire is configured as a gate input. When this wire is pulled low (e.g., to the sensor ground; 0-0.5 V dc), it inhibits the outputs from switching, while all other sensor functions continue to be enabled. This feature is useful for controlling when the outputs are allowed to change states. Gate input function response time is 1 millisecond.

### Wiring

NPN, 4-20 mA Output Models

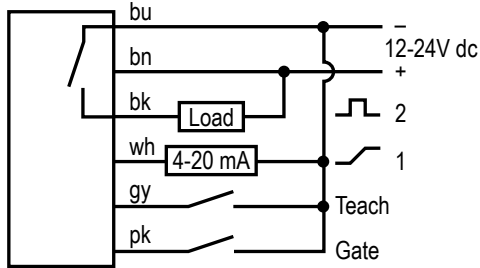

NPN, 0-10V dc Output Models

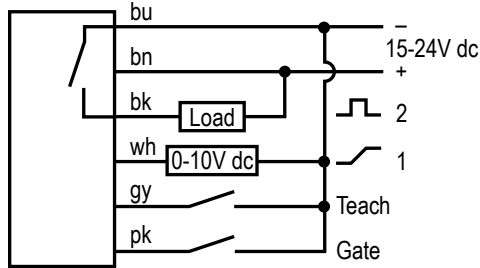

PNP, 4-20 mA Output Models

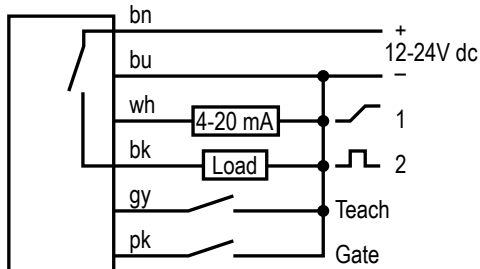

PNP, 0-10V dc Output Models

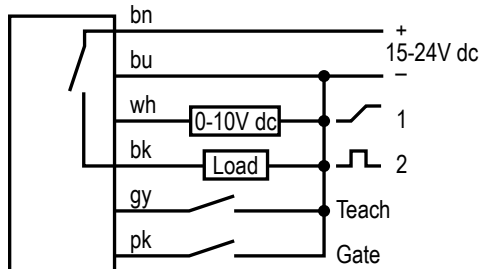

NOTE: QD hookups are functionally identical.

### Installation

Install the product on a 35 mm DIN rail or the included mounting bracket.

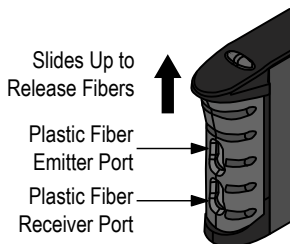

## Specifications

### Required Fiber-Optic Cable

Banner P-Series plastic fibers

### Sensing Beam

680 nm visible red or 525 nm visible green, depending on model

### Supply Voltage and Current

4-20 mA Analog Models: 12 to 24 V dc (10% maximum ripple) at less than 65 mA, exclusive of load

0-10 V dc Analog Models: 15 to 24 V dc (10% maximum ripple) at less than 70 mA, exclusive of load

### Supply Protection Circuitry

Protected against reverse polarity and transient voltage

### Output Configuration

Two independently configurable outputs, depending on model: NPN w/analog (4-20 mA or 0-10 V) or PNP w/analog (4-20 mA or 0-10 V)

### Output Rating

Discrete Output: 150 mA, maximum load

OFF-state leakage current: < 10 µA at 24 V dc

ON-state saturation voltage: NPN: < 1.5 V at 150 mA load; PNP < 2.5 V at 150 mA load

Analog Output: 4-20 mA or 0-10 V dc

Load: 4-20 mA Models: 100Ω maximum impedance; 0-10 V dc Models: 1 MΩ min. impedance

### Operating Conditions

Temperature: -20 to +55 °C (-4 to +131 °F)

Storage: -20 to +80 °C (-4 to +175 °F)

Max. Rel. Humidity: 90% at 50 °C (non-condensing)

Number of Devices, Stacked	Ambient Temperature Rating	Load Specification
3	55 °C (131 °F)	150 mA
7	50 °C (122 °F)	50 mA
10	45 °C (113 °F)	50 mA

### Environmental Rating

IEC IP50, NEMA 1

### Certifications



### Adjustments

Push-button or remote programming of response time, OFF-delay, light/dark operate, and display

### Indicators

Four-digit digital display plus LED indicators for active channel, push-button lockout, OFF-delay and light/dark operate selection; 2 yellow output indicators

### Construction

Black ABS/polycarbonate alloy (UL94 V-0 rated) housing, clear polycarbonate cover

### Connections

PVC-jacketed 2 m or 9 m (6.5 ft or 30 ft) 6-wire integral cable or integral 6-pin Pico-style quick-disconnect

### Installation

35 mm DIN rail or included mounting bracket

### Output Response Time

Discrete Output: Programmable, 50 microseconds, 200 microseconds, 1 millisecond, 2.5 milliseconds

Analog Output: 1 millisecond



NOTE: < 1 second delay on power-up; outputs do not conduct during this time.

### Output Protection Circuitry

Protected against false pulse on power-up and continuous short-circuit

### Required Overcurrent Protection



WARNING: Electrical connections must be made by qualified personnel in accordance with local and national electrical codes and regulations.

Overcurrent protection is required to be provided by end product application per the supplied table.

Overcurrent protection may be provided with external fusing or via Current Limiting, Class 2 Power Supply.

Supply wiring leads < 24 AWG shall not be spliced.

For additional product support, go to <http://www.bannerengineering.com>.

Supply Wiring (AWG)	Required Overcurrent Protection (Amps)
20	5.0
22	3.0
24	2.0
26	1.0
28	0.8
30	0.5

## Dimensions

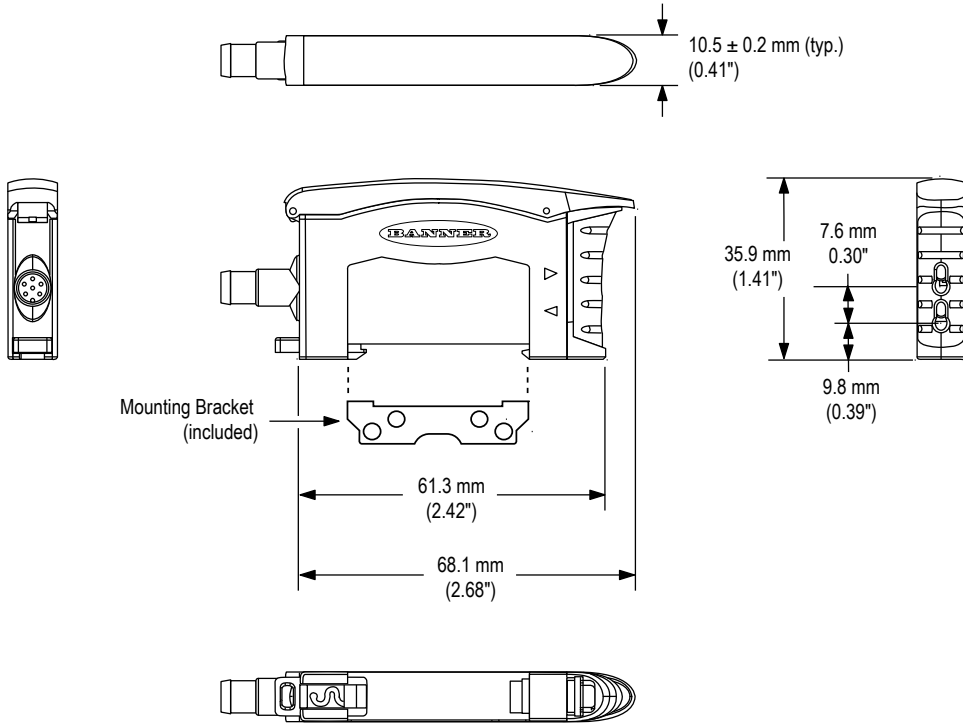

### Included Bracket Dimensions

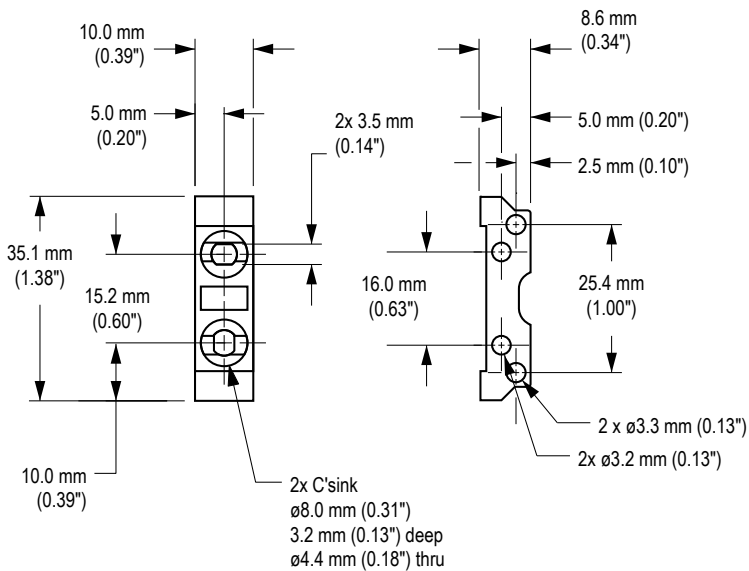

#### M3 Hardware included:

- Lock Washer (2)
- Flat Washer (2)
- Screws (2)
- Hex Nuts (2)

## Accessories

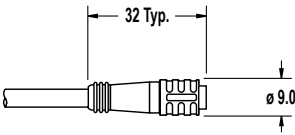
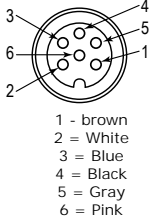
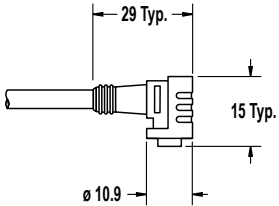
6-Pin Snap-on M8/Pico-Style Cordsets				
Model	Length	Style	Dimensions	Pinout (Female)
PKG6Z-2	2 m (6.5 ft)	Straight		
PKG6Z-9	9 m (30 ft)			
PKW6Z-2	2 m (6.5 ft)	Right-angle		
PKW6Z-9	9 m (30 ft)			

## Banner Engineering Corp. Limited Warranty

Banner Engineering Corp. warrants its products to be free from defects in material and workmanship for one year following the date of shipment. Banner Engineering Corp. will repair or replace, free of charge, any product of its manufacture which, at the time it is returned to the factory, is found to have been defective during the warranty period. This warranty does not cover damage or liability for misuse, abuse, or the improper application or installation of the Banner product.

THIS LIMITED WARRANTY IS EXCLUSIVE AND IN LIEU OF ALL OTHER WARRANTIES WHETHER EXPRESS OR IMPLIED (INCLUDING, WITHOUT LIMITATION, ANY WARRANTY OF MERCHANTABILITY OR FITNESS FOR A PARTICULAR PURPOSE), AND WHETHER ARISING UNDER COURSE OF PERFORMANCE, COURSE OF DEALING OR TRADE USAGE.

This Warranty is exclusive and limited to repair or, at the discretion of Banner Engineering Corp., replacement. IN NO EVENT SHALL BANNER ENGINEERING CORP. BE LIABLE TO BUYER OR ANY OTHER PERSON OR ENTITY FOR ANY EXTRA COSTS, EXPENSES, LOSSES, LOSS OF PROFITS, OR ANY INCIDENTAL, CONSEQUENTIAL OR SPECIAL DAMAGES RESULTING FROM ANY PRODUCT DEFECT OR FROM THE USE OR INABILITY TO USE THE PRODUCT, WHETHER ARISING IN CONTRACT OR WARRANTY, STATUTE, TORT, STRICT LIABILITY, NEGLIGENCE, OR OTHERWISE.

Banner Engineering Corp. reserves the right to change, modify or improve the design of the product without assuming any obligations or liabilities relating to any product previously manufactured by Banner Engineering Corp. Any misuse, abuse, or improper application or installation of this product or use of the product for personal protection applications when the product is identified as not intended for such purposes will void the product warranty. Any modifications to this product without prior express approval by Banner Engineering Corp will void the product warranties. All specifications published in this document are subject to change; Banner reserves the right to modify product specifications or update documentation at any time. For the most recent version of any documentation, refer to: [www.bannerengineering.com](http://www.bannerengineering.com).