



Technical Data Sheet

Full Color Chip LED (Chip LED with Right Angle Lens)

12-23A/R6GHBHC-A01/2D

Features

- Package in 8mm tape on 7" diameter reel.
- Compatible with automatic placement equipment.
- Compatible with infrared and vapor phase reflow solder process.
- Full-color type.
- Pb Free
- The product itself will remain within RoHS compliant version.



Descriptions

- The 12-23A SMD Taping is much smaller than lead frame type components, thus enable smaller board size, higher packing density, reduced storage space and finally smaller equipment to be obtained.
- Besides, lightweight makes them ideal for miniature applications. etc.

Applications

- Automotive: backlighting in dashboard and switch.
- Telecommunication: indicator and backlighting in telephone and fax.
- Flat backlight for LCD, switch and symbol.
- General use.

Device Selection Guide

Chip			Lens Color
Type	Material	Emitted Color	
R6	AlGaInP	Brilliant Red	Water Clear
GH	InGaN	Brilliant Green	
BH	InGaN	Blue	

12-23A/R6GHBHC-A01/2D

Package Outline Dimensions

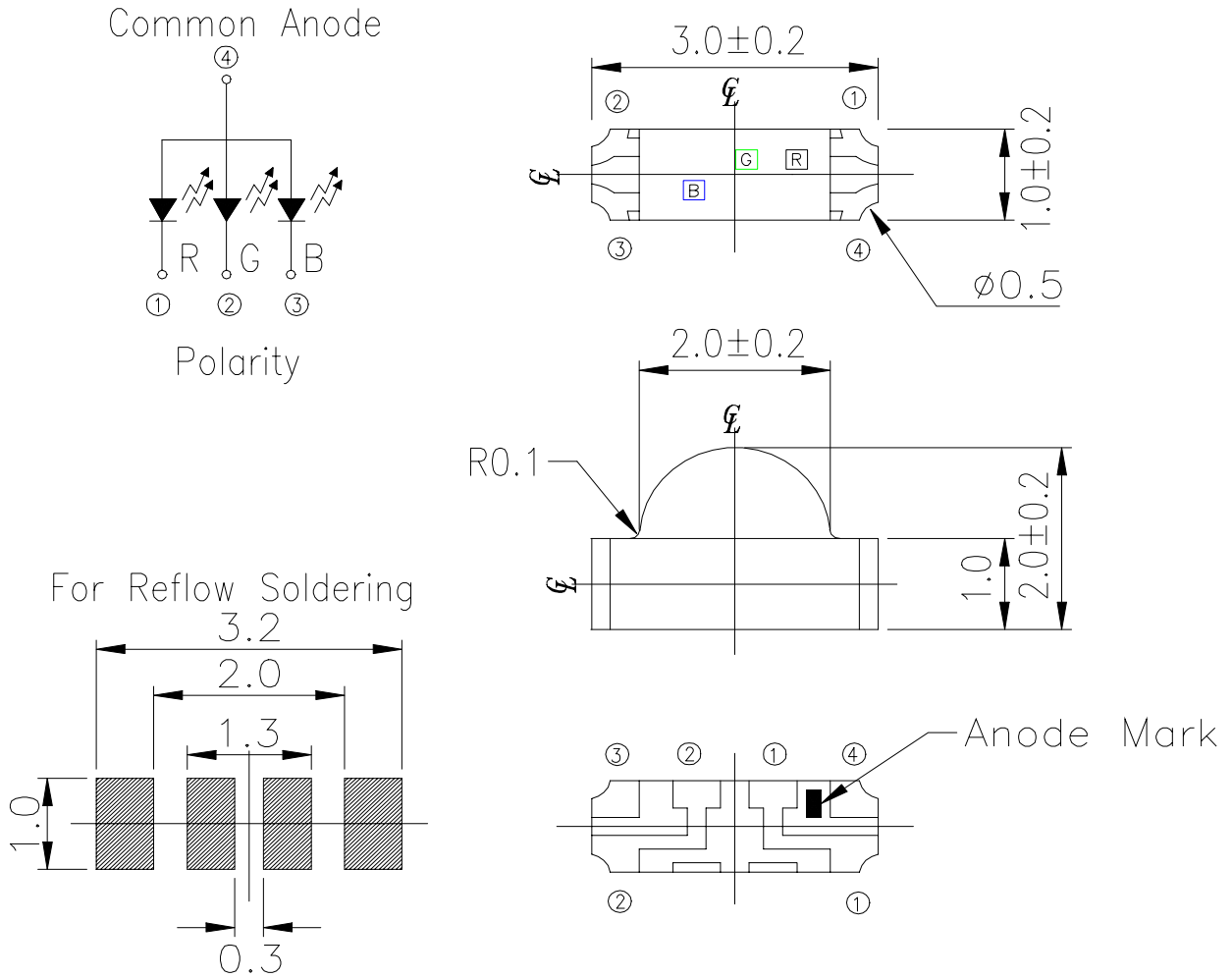

Note: The tolerances unless mentioned is $\pm 0.1\text{mm}$, Angle $\pm 0.5^\circ$, Unit = mm

12-23A/R6GHBHC-A01/2D**Absolute Maximum Ratings (Ta=25°C)**

Parameter	Symbol	Rating	Unit
Reverse Voltage	V _R	5	V
Forward Current	I _F	R6:25 GH:25 BH:25	mA
Operating Temperature	T _{opr}	-40 ~ +85	°C
Storage Temperature	T _{stg}	-40 ~ +90	°C
Soldering Temperature	T _{sol}	260 (for 5 seconds)	°C
Electrostatic Discharge	ESD	R6:2000 GH:150 BH:150	V
Power Dissipation	P _d	R6:60 GH:110 BH:110	mW
Peak Forward Current (Duty 1/10 @1KHz)	I _{F (Peak)}	R6:60 GH:100 BH:100	mA

12-23A/R6GHBHC-A01/2D
Electro-Optical Characteristics (Ta=25°C)

Parameter	Symbol	Min.	Typ.	Max.	Unit	Condition
Luminous Intensity	R6	57	90			If=20mA
	Iv GH	112	180	-----	mcd	
	BH	45	72			
Viewing Angle	2θ 1/2	-----	120	-----	deg	If=20mA
Peak Wavelength	R6		632			If=20mA
	λ_p GH	-----	518	-----	nm	
	BH		468			
Dominant Wavelength	R6		624			If=20mA
	λ_d GH	-----	525	-----	nm	
	BH		470			
Spectrum Radiation Bandwidth	R6		20			If=20mA
	$\Delta\lambda$ GH	-----	35	-----	nm	
	BH		35			
Forward Voltage	R6		2.0	2.4		If=20mA
	Vf GH	-----	3.5	3.9	V	
	BH		3.5	3.9		
Reverse Current	R6			10		VR=5V
	IR GH	-----	-----	50	μA	
	BH			50		

Notes:

- 1.Tolerance of Luminous Intensity $\pm 10\%$
- 2.Tolerance of Dominant Wavelength $\pm 1nm$
- 3.Tolerance of Forward Voltage $\pm 0.1V$

12-23A/R6GHBHC-A01/2D

Typical Electro-Optical Characteristics Curves

R6

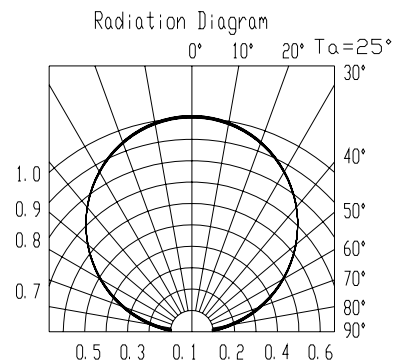
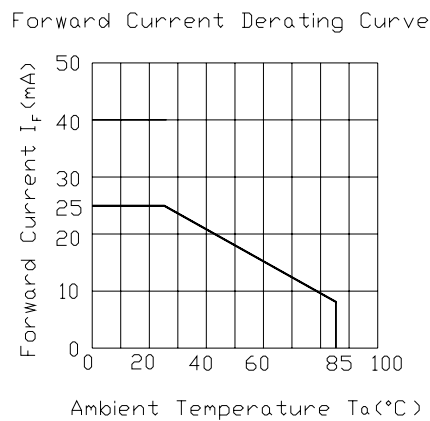
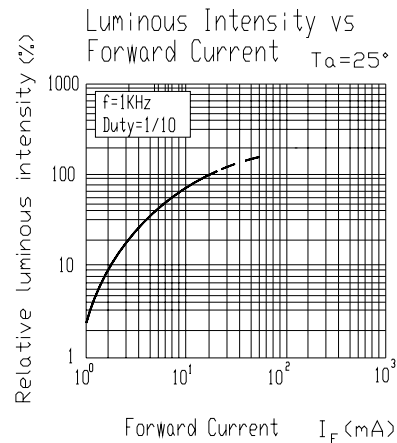
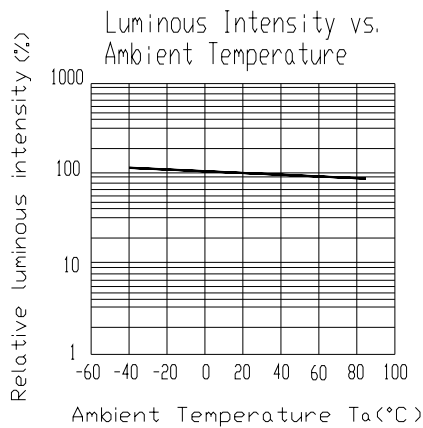
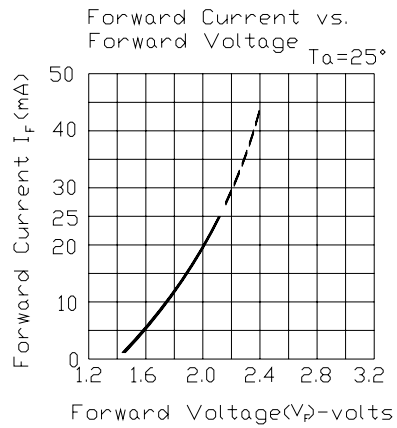
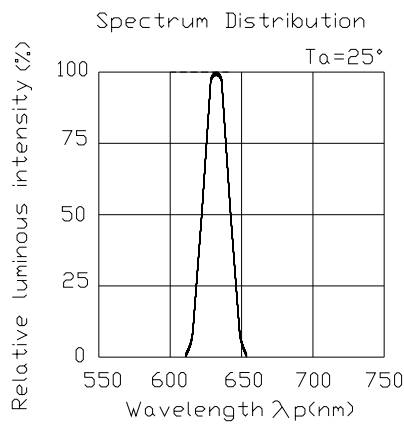

12-23A/R6GHBHC-A01/2D

Typical Electro-Optical Characteristics Curves

GH

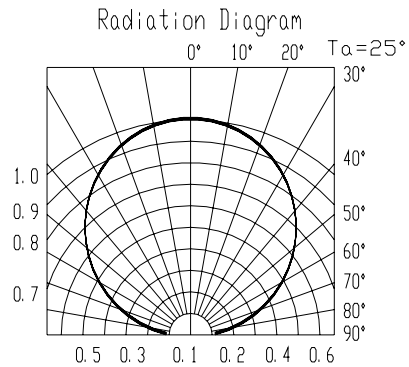
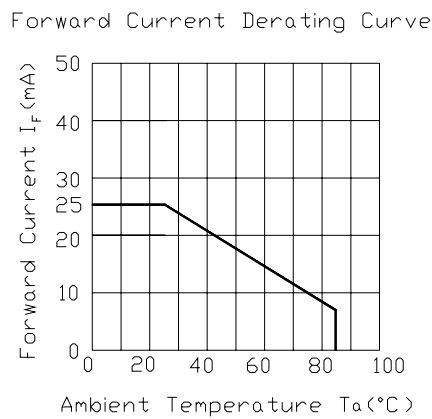
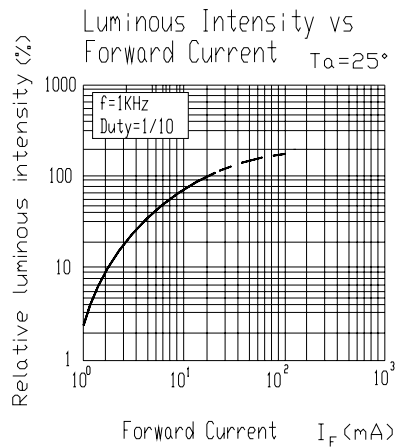
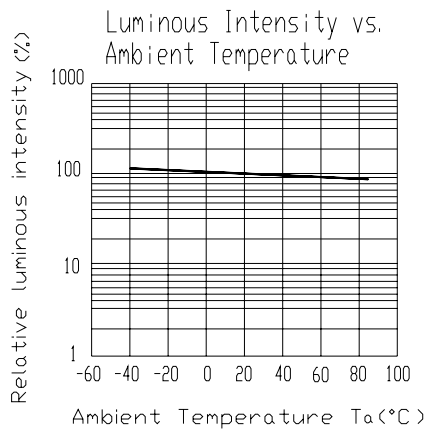
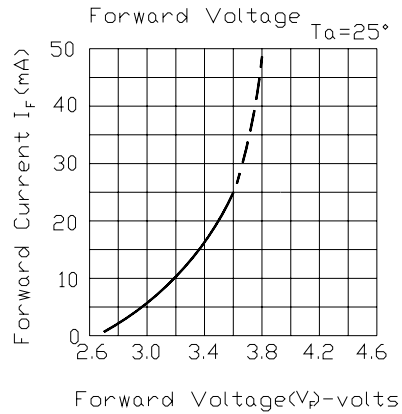
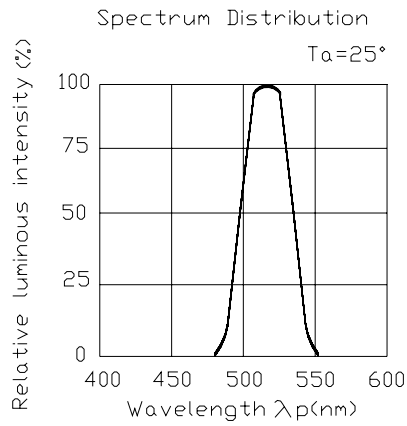

12-23A/R6GHBHC-A01/2D

Typical Electro-Optical Characteristics Curves

BH

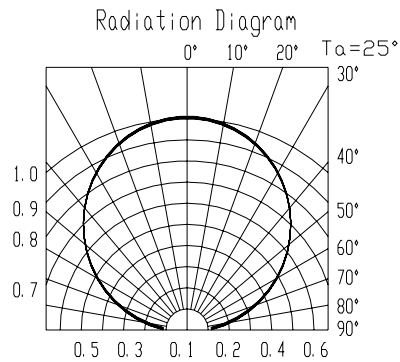
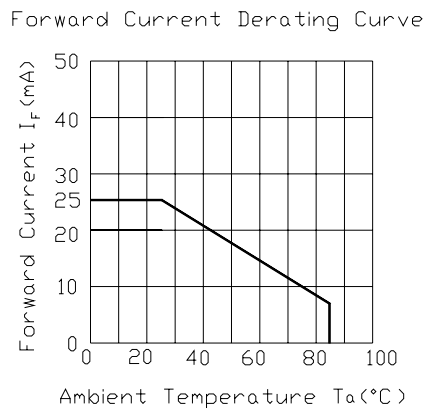
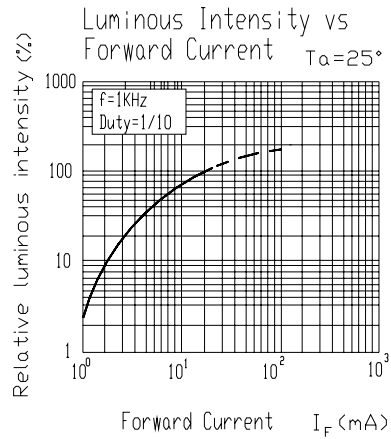
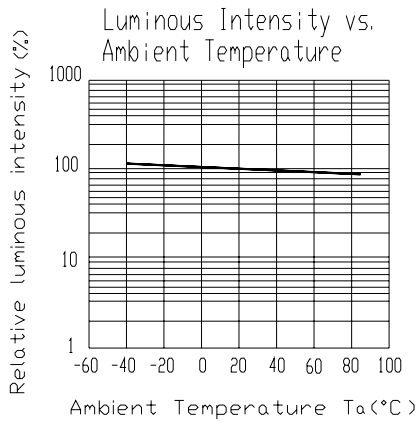
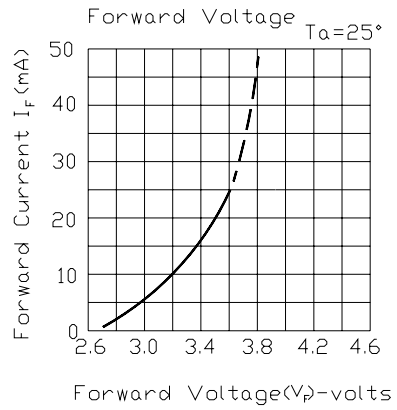
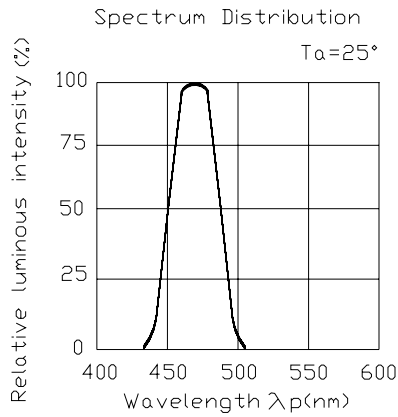

12-23A/R6GHBHC-A01/2D

■ **Carrier Tape Dimensions: Loaded quantity 2000 PCS per reel**

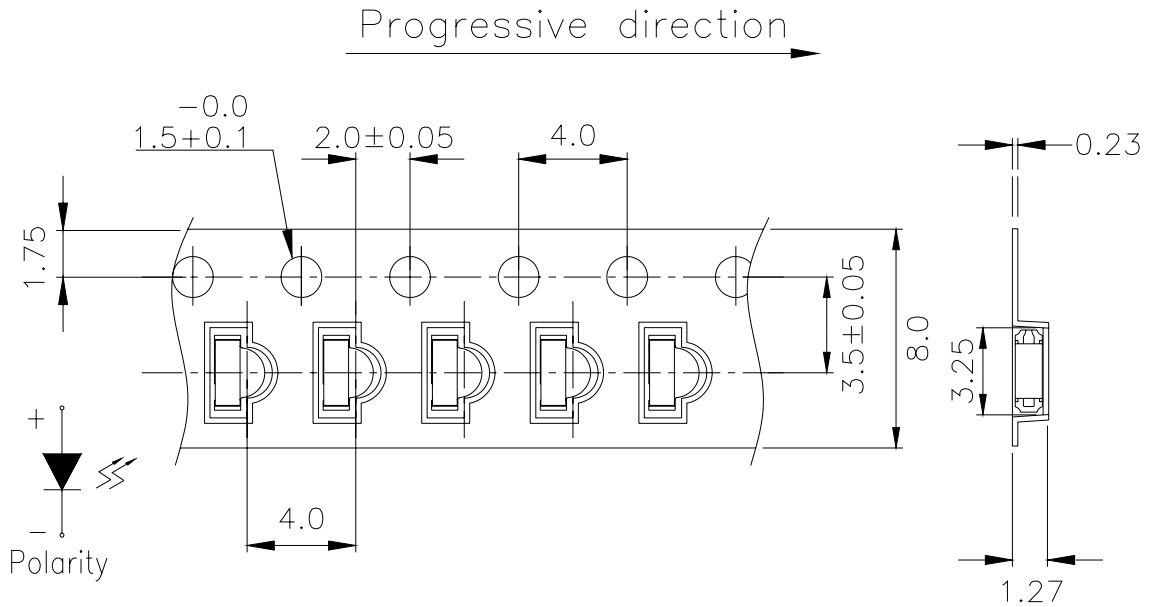

Note: The tolerances unless mentioned is $\pm 0.1\text{mm}$, Angle $\pm 0.5^\circ$,Unit = mm

■ **Moisture Resistant Packaging**

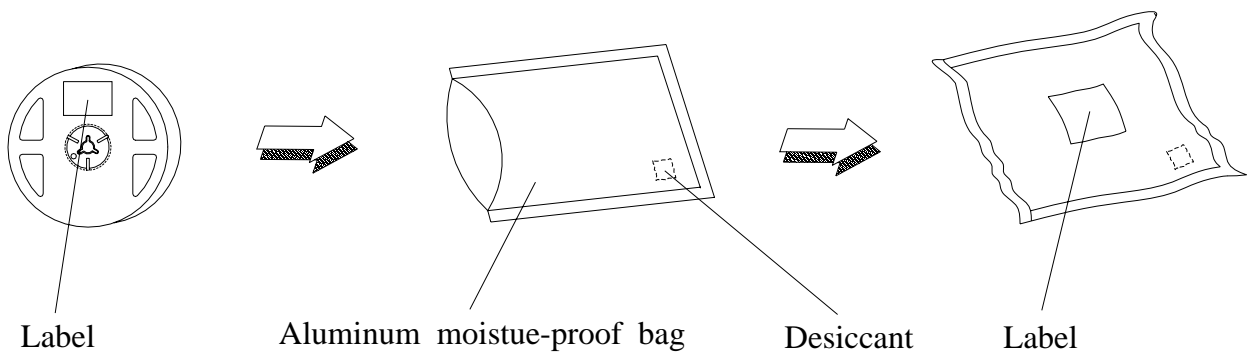

12-23A/R6GHBHC-A01/2D
Reliability Test Items And Conditions

The reliability of products shall be satisfied with items listed below.

Confidence level : 90 %

LTPD : 10 %

No.	Items	Test Condition	Test Hours/Cycles	Sample Size	Ac/Rc
1	Reflow	Temp. : 240°C±5°C Min. 5 sec.	6 min.	22 Pcs.	0/1
2	Temperature Cycle	H : +100°C 15min. ∫ 5 min. L : -40°C 15min.	300 Cycles	22 Pcs.	0/1
3	Thermal Shock	H : +100°C 5min. ∫ 10 sec. L : -10°C 5min.	300 Cycles	22 Pcs.	0/1
4	High Temperature Storage	Temp. : 100°C	1000 Hrs.	22 Pcs.	0/1
5	Low Temperature Storage	Temp. : -55°C	1000 Hrs.	22 Pcs.	0/1
6	DC Operating Life	IF = 20 mA	1000 Hrs.	22 Pcs.	0/1
7	High Temperature / High Humidity	85°C/R.H85%	1000 Hrs.	22 Pcs.	0/1

12-23A/R6GHBHC-A01/2D

Precautions For Use

1. Over-current-proof

Customer must apply resistors for protection , otherwise slight voltage shift will cause big current change (Burn out will happen).

2. Storage

- 2.1 Do not open moisture proof bag before the products are ready to use.
- 2.2 Before opening the package, the LEDs should be kept at 30°C or less and 90%RH or less.
- 2.3 The LEDs should be used within a year.
- 2.4 After opening the package, the LEDs should be kept at 30°C or less and 70%RH or less.
- 2.5 The LEDs should be used within 168 hours (7 days) after opening the package.
- 2.6 If the moisture absorbent material (silica gel) has faded away or the LEDs have exceeded the storage time, baking treatment should be performed using the following conditions.
Baking treatment : 60±5°C for 24 hours.

3. Soldering Condition

3.1 Lead solder temperature profile

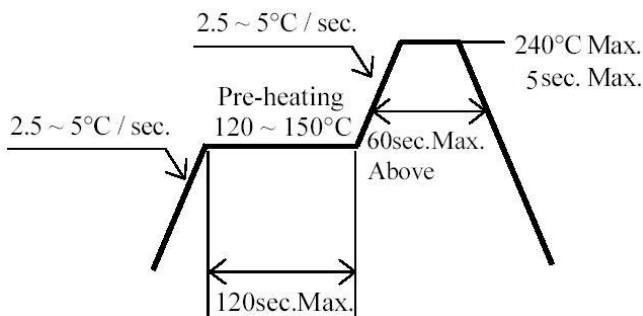

3.2 Lead free solder Lead solder temperature profile

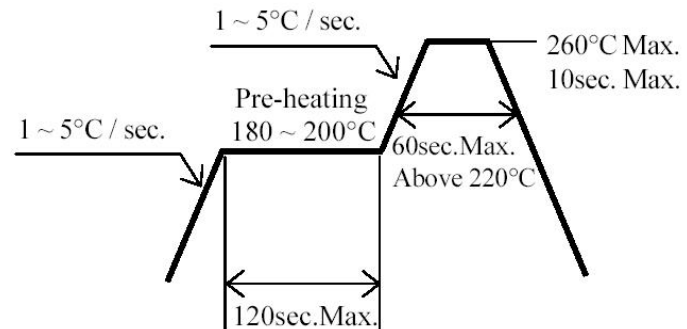

- 3.3 Reflow soldering should not be done more than two times.
- 3.4 When soldering, do not put stress on the LEDs during heating.
- 3.5 After soldering, do not warp the circuit board.

12-23A/R6GHBHC-A01/2D**4. Soldering Iron**

Each terminal is to go to the tip of soldering iron temperature less than 280°C for 3 seconds within once in less than the soldering iron capacity 25W. Leave two seconds and more intervals, and do soldering of each terminal. Be careful because the damage of the product is often started at the time of the hand solder.

5.Repairing

Repair should not be done after the LEDs have been soldered. When repairing is unavoidable, a double-head soldering iron should be used (as below figure). It should be confirmed beforehand whether the characteristics of the LEDs will or will not be damaged by repairing.

