

Features

- **70mW High Side MOSFET**
- **Continuous Current**
-APL3520A/B: 1.5A
-APL3520C/D: 1A
- **Wide Supply Voltage Range: 2.7V to 5.5V**
- **Current Limit and Short-Circuit Protections**
- **Over-Temperature Protection**
- **Deglitched Fault Indication Output**
- **Logic Level Enable Input**
- **Lead Free and Green Devices Available (RoHS Compliant)**
- **UL Approved-File No. 20121029-E328191**
- **Nemko IEC 60950-1 CB_Scheme Certified, No. NO70693**
- **TUV IEC 60950-1 and EN 60950-1 Certified, No.44 780 12 406748-007**

General Description

The APL3520 series of power switches are designed for USB applications. The 70mΩ N-channel MOSFET power switch satisfies the voltage drop requirements of USB specification.

The protection features include current-limit protection, short circuit protection, and over-temperature protection. The device limits the output current at current limit threshold level, and when V_{OUT} drops below 1.5V, the devices limit the current to a lower and safe level. The OTP limits the junction temperature below 140°C in case of short circuit or over load conditions.

Other features include deglitched OCBx output to indicate the fault condition and ENx input to turn on or turn off output.

Applications

- **Notebook and Desktop Computers**
- **USB Ports**
- **High-Side Power Protection Switches**

Simplified Application Circuit

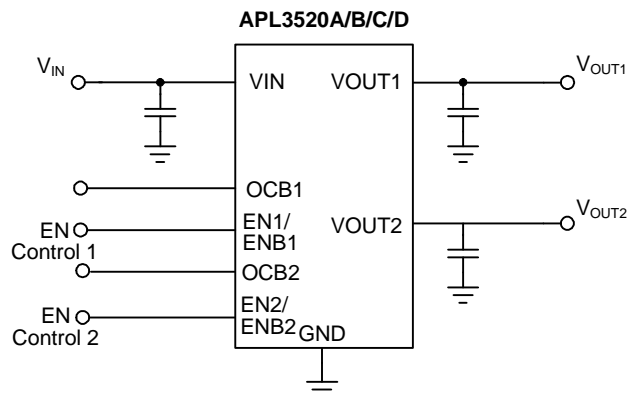

ANPEC reserves the right to make changes to improve reliability or manufacturability without notice, and advise customers to obtain the latest version of relevant information to verify before placing orders.

Pin Configurations

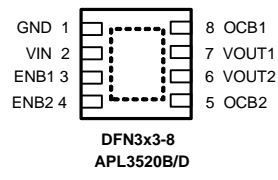
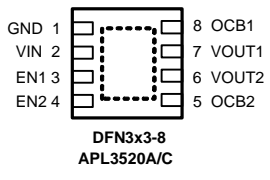
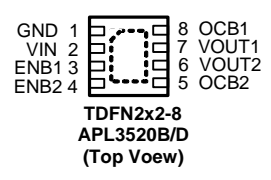
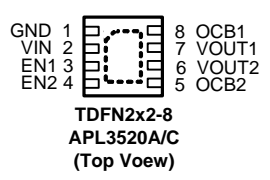
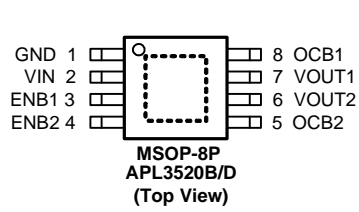
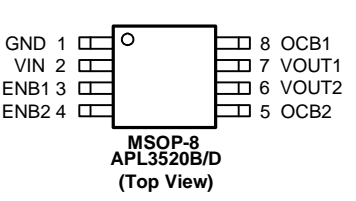
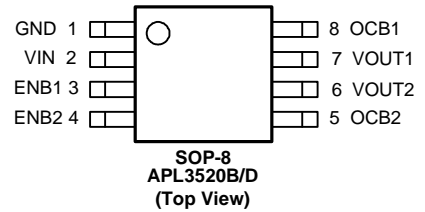
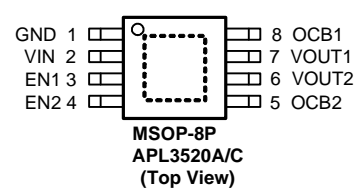
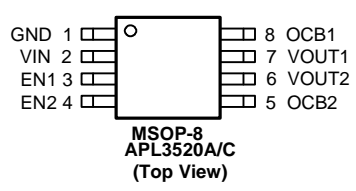
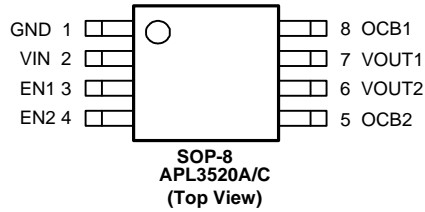

= Exposed Pad
 (connected to ground plane for better heat dissipation)

Ordering and Marking Information

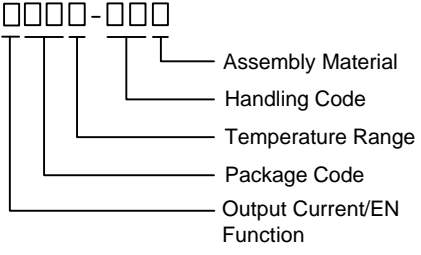
<p>APL3520 □□□□-□□□</p>  <p> Assembly Material Handling Code Temperature Range Package Code Output Current/EN Function </p>	<p>Package Code K : SOP-8 X : MSOP-8 XA : MSOP-8P QB : TDFN2x2-8 QA : DFN3x3-8 Operating Ambient Temperature Range I : -40 to 85 °C Handling Code TR : Tape & Reel Output Current/EN Function A : 1.5A/Active High B : 1.5A/ Active Low C : 1A/Active High D : 1A/Active Low Assembly Material G : Halogen and Lead Free Device</p>					
APL3520A/B/C/D K:	<table border="1" style="width: 100%; text-align: center;"> <tr> <td style="width: 25%;">APL3520A XXXXX</td> <td style="width: 25%;">APL3520B XXXXX</td> <td style="width: 25%;">APL3520C XXXXX</td> <td style="width: 25%;">APL3520D XXXXX</td> </tr> </table>	APL3520A XXXXX	APL3520B XXXXX	APL3520C XXXXX	APL3520D XXXXX	XXXXX - Date Code
APL3520A XXXXX	APL3520B XXXXX	APL3520C XXXXX	APL3520D XXXXX			
APL3520A/B/C/D X: APL3520A/B/C/D XA:	<table border="1" style="width: 100%; text-align: center;"> <tr> <td style="width: 25%;">L520A XXX XX</td> <td style="width: 25%;">L520B XXX XX</td> <td style="width: 25%;">L520C XXX XX</td> <td style="width: 25%;">L520D XXX XX</td> </tr> </table>	L520A XXX XX	L520B XXX XX	L520C XXX XX	L520D XXX XX	XXX - Date Code XX
L520A XXX XX	L520B XXX XX	L520C XXX XX	L520D XXX XX			
APL3520A/B/C/D QB:	<table border="1" style="width: 100%; text-align: center;"> <tr> <td style="width: 25%;">L20A X</td> <td style="width: 25%;">L20B X</td> <td style="width: 25%;">L20C X</td> <td style="width: 25%;">L20D X</td> </tr> </table>	L20A X	L20B X	L20C X	L20D X	X - Date Code
L20A X	L20B X	L20C X	L20D X			
APL3520A/B/C/D QA:	<table border="1" style="width: 100%; text-align: center;"> <tr> <td style="width: 25%;">APL 3520A XXXXX</td> <td style="width: 25%;">APL 3520B XXXXX</td> <td style="width: 25%;">APL 3520C XXXXX</td> <td style="width: 25%;">APL 3520D XXXXX</td> </tr> </table>	APL 3520A XXXXX	APL 3520B XXXXX	APL 3520C XXXXX	APL 3520D XXXXX	XXXXX - Date Code
APL 3520A XXXXX	APL 3520B XXXXX	APL 3520C XXXXX	APL 3520D XXXXX			

Note : ANPEC lead-free products contain molding compounds/die attach materials and 100% matte tin plate termination finish; which are fully compliant with RoHS. ANPEC lead-free products meet or exceed the lead-free requirements of IPC/JEDEC J-STD-020C for MSL classification at lead-free peak reflow temperature. ANPEC defines "Green" to mean lead-free (RoHS compliant) and halogen free (Br or Cl does not exceed 900ppm by weight in homogeneous material and total of Br and Cl does not exceed 1500ppm by weight).

Absolute Maximum Ratings (Note 1)

Symbol	Parameter	Rating	Unit
V_{IN}	VIN Input Voltage (VIN to GND)	-0.3 ~ 5.7	V
V_{OUT1}, V_{OUT2}	VOUT1, VOUT2 to GND Voltage	-0.3 ~ 5.7	V
V_{EN1}, V_{EN2}	EN1, EN2 to GND Voltage (APL3520A/C)	-0.3 ~ 5.7	V
V_{ENB1}, V_{ENB2}	ENB1, ENB2 to GND Voltage (APL3520B/D)	-0.3 ~ 5.7	V
V_{OCB1}, V_{OCB2}	OCB1, OCB2 to GND Voltage	-0.3 ~ 5.7	V
T_J	Maximum Junction Temperature	150	°C
T_{STG}	Storage Temperature	-65 ~ 150	°C
T_{SDR}	Maximum Lead Soldering Temperature, 10 Seconds	260	°C
	ESD Immunity	HBM (Human Body Mode)	2 kV
		MM (Machine Mode)	200 V

Note1: Stresses beyond those listed under "absolute maximum ratings" may cause permanent damage to the device. These are stress ratings only and functional operation of the device at these or any other conditions beyond those indicated under "recommended operating conditions" is not implied. Exposure to absolute maximum rating conditions for extended periods may affect device reliability.

Thermal Characteristics

Symbol	Parameter	Typical Value	Unit
θ_{JA}	Junction-to-Ambient Resistance in Free Air ^(Note 2)		°C/W
	SOP-8	95	
	MSOP-8	160	
	MSOP-8P	50	
	TDFN2x2-8	80	
	DFN3x3-8	70	

Note 2 : θ_{JA} is measured with the component mounted on a high effective thermal conductivity test board in free air.

Recommended Operating Conditions (Note 3)

Symbol	Parameter	Range	Unit
V_{IN}	VIN Input Voltage	2.7 ~ 5.5	V
I_{OUT}	OUT Output Current (Each Port)	APL3520A/B	0 ~ 1.5
		APL3520C/D	0 ~ 1
T_A	Ambient Temperature	-40 ~ 85	°C
T_J	Junction Temperature	-40 ~ 125	°C

Note 3 : Refer to the typical application circuit

Electrical Characteristics

Unless otherwise specified, these specifications apply over $V_{IN}=5V$, $V_{EN}=5V$ or $V_{ENB}=0V$ and $T_A = -40 \sim 85^\circ C$. Typical values are at $T_A=25^\circ C$.

Symbol	Parameter	Test Conditions	APL3520			Unit	
			Min.	Typ.	Max.		
SUPPLY CURRENT							
	VIN Supply Current	No load, $V_{EN1}=V_{EN2}=0V$ or $V_{ENB1}=V_{ENB2}=5V$	-	-	1	μA	
		No load, $V_{EN1}=V_{EN2}=5V$ or $V_{ENB1}=V_{ENB2}=0V$	-	90	-	μA	
	Leakage Current	$V_{OUT1}=GND$, $V_{EN1}=0V$ or $V_{ENB1}=5V$ $V_{OUT2}=GND$, $V_{EN2}=0V$ or $V_{ENB2}=5V$	-	-	1	μA	
	Reverse Leakage Current	$V_{IN}=GND$, $V_{OUT1}=5V$ $V_{IN}=GND$, $V_{OUT2}=5V$	-	0	1	μA	
POWER SWITCH1 & POWER SWITCH2							
$R_{DS(ON)}$	Power Switch On Resistance	$I_{OUT}=1A$, $T_A=25^\circ C$	-	70	-	$m\Omega$	
		$I_{OUT}=1A$, $T_A=-40 \sim 85^\circ C$	-	70	-	$m\Omega$	
UNDER-VOLTAGE LOCKOUT (UVLO)							
	VIN UVLO Threshold Voltage	V_{IN} rising, $T_A=-40 \sim 85^\circ C$	1.7	-	2.65	V	
	VIN UVLO Hysteresis		-	0.2	-	V	
PROTECTIONS (CURRENT LIMIT1/2 AND SHORT-CIRCUIT1/2)							
I_{LIM}	Current Limit Threshold	$V_{IN}=2.7V$ to $5.5V$, $T_A=-40 \sim 85^\circ C$	APL3520A/B	-	3.2	3.9	A
			APL3520C/D	-	1.7	2.3	A
I_{SHORT}	Short-Circuit Output Current	$V_{IN}=2.7V$ to $5.5V$	APL3520A/B	-	1.5	-	A
			APL3520C/D	-	0.8	-	A
FAULT INDICATION OUTPUT (OCB1 AND OCB2)							
	OCB Output Low Voltage	$I_{OCB}=5mA$	-	0.2	0.4	V	
	OCB Leakage Current	$V_{OCB}=5V$	-	-	1	μA	
$t_{D(OCB)}$	OCB Deglitch Time	OCB assertion, $T_A=-40 \sim 85^\circ C$	4	10	15	ms	
ENABLE/DISABLE (EN1/ENB1 AND EN2/ENB2)							
V_{IH}	Input Logic HIGH	$V_{IN}=2.7V$ to $5V$	2	-	-	V	
V_{IL}	Input Logic LOW	$V_{IN}=2.7V$ to $5V$	-	-	0.8	V	
	Input Current		-	-	1	μA	
	VOU T Discharge Resistance	$V_{EN}=0V$ or $V_{ENB}=5V$,	-	40	100	Ω	
$t_{D(ON)}$	Turn on Delay Time		-	30	-	μs	
$t_{D(OFF)}$	Turn off Delay Time		-	5	-	μs	
t_{SS}	Soft-Start Time	No load, $C_{OUT}=1\mu F$, $V_{IN}=5V$	-	400	-	μs	
OVERT-TEMPERATURE PROTECTION (OTP1 & OTP2)							
T_{OTP}	Over-Temperature Threshold	T_J rising	-	140	-	$^\circ C$	
	Over-Temperature Hysteresis		-	20	-	$^\circ C$	

Pin Description

PIN		FUNCTION
NO.	NAME	
1	GND	Ground.
2	VIN	Power Supply Input. Connect this pin to external DC supply.
3	EN1 (APL3520A/C)	Enable Input. Pulling this pin to high will enable the device and pulling this pin to low will disable device. The EN1 pin cannot be left floating.
	ENB1 (APL3520B/D)	Enable Input. Pulling this pin to high will disable the device and pulling this pin to low will enable device. The ENB1 pin cannot be left floating.
4	EN2 (APL3520A/C)	Enable Input. Pulling this pin to high will enable the device and pulling this pin to low will disable device. The EN2 pin cannot be left floating.
	ENB2 (APL3520B/D)	Enable Input. Pulling this pin to high will disable the device and pulling this pin to low will enable device. The ENB2 pin cannot be left floating.
5	OCB2	Fault Indication Pin. This pin goes low when a current limit or an over-temperature condition is detected in VOUT2 after a 10ms deglitch time.
6	VOUT2	Output Voltage Pin. The output voltage follows the input voltage. When ENB2 is high or EN2 is low the output voltage is discharged by an internal resistor.
7	VOUT1	Output Voltage Pin. The output voltage follows the input voltage. When ENB1 is high or EN1 is low the output voltage is discharged by an internal resistor.
8	OCB1	Fault Indication Pin. This pin goes low when a current limit or an over-temperature condition is detected in VOUT1 after a 10ms deglitch time.
-	EP	Exposed Pad. Connect it to a large ground plane for heat sinking. (TDFN2x2-8, MSOP-8P)

Typical Operating Characteristics

Switch On Resistance vs. Junction Temperature

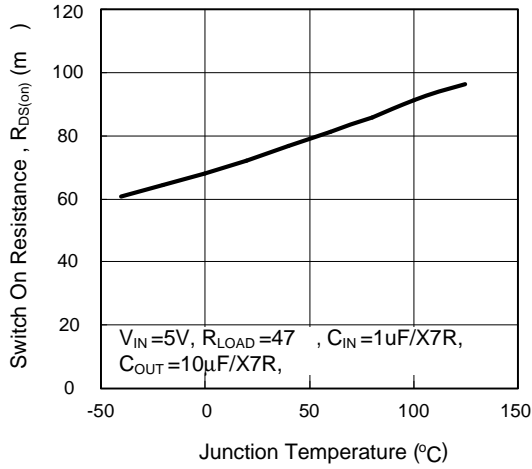

Switch On Resistance vs. Input Voltage

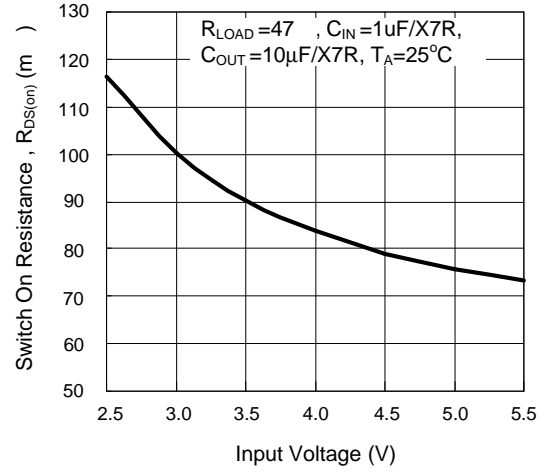

Supply Current vs. Junction Temperature

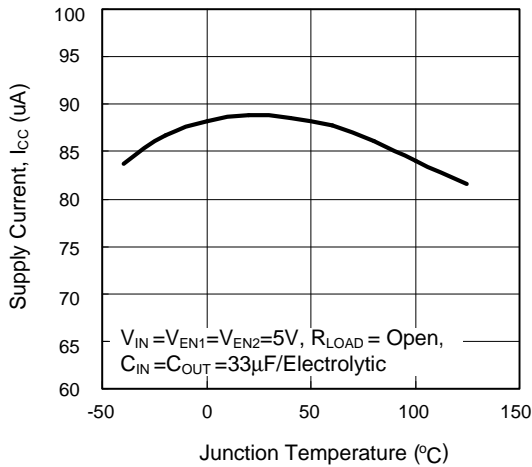

Supply Current vs. Input Voltage

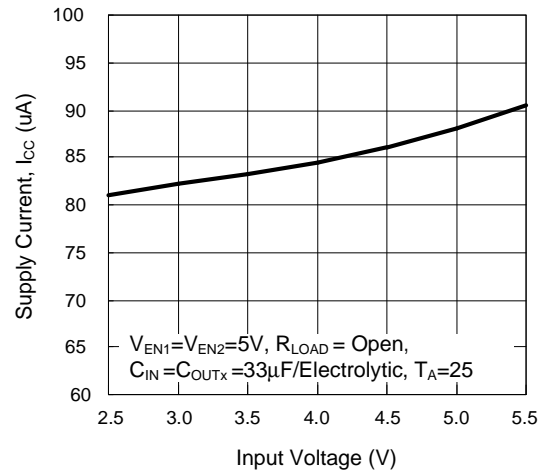

Switch Off Supply Current vs. Junction Temperature

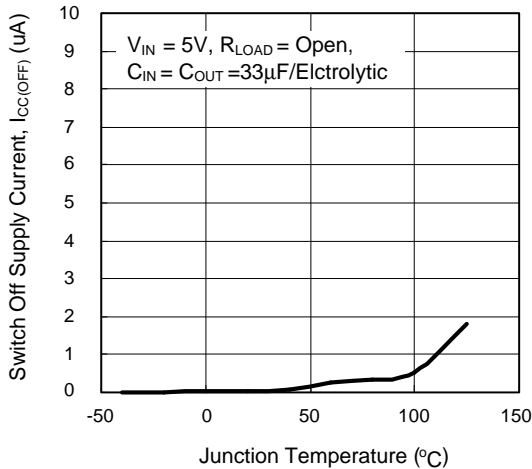

Current Limit Threshold vs. Input Voltage

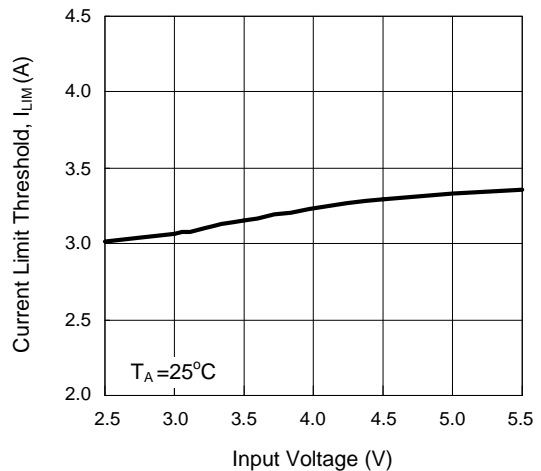

Typical Operating Characteristics

Current-Limit Response vs. Output Peak Current

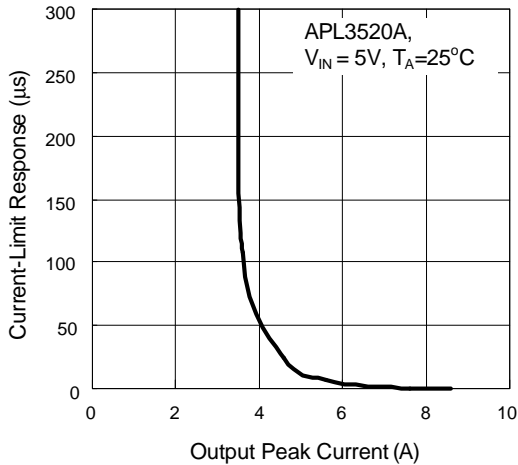

Current Limit Threshold vs. Junction Temperature

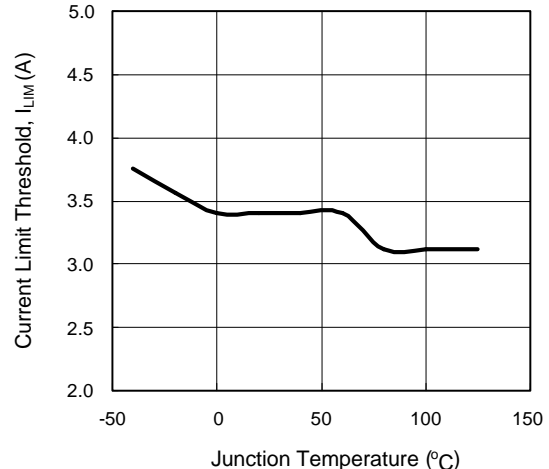

Short-Circuit Output Current vs. Input Voltage

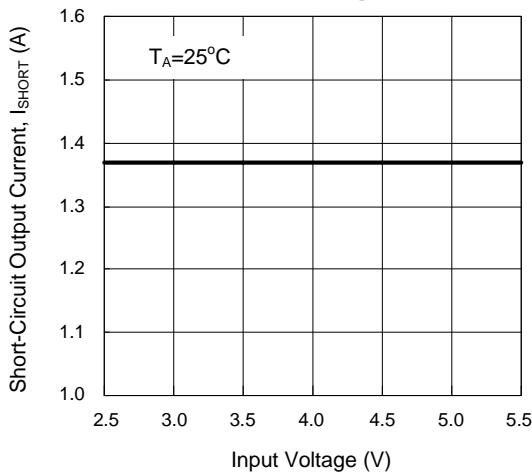

EN pin Threshold Voltage vs. Junction Temperature

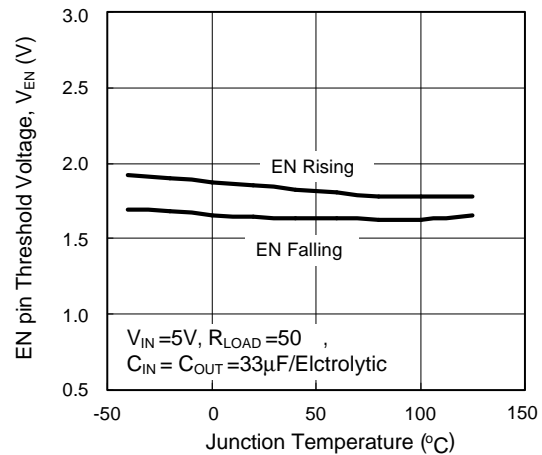

EN pin Threshold Voltage vs. Input Voltage

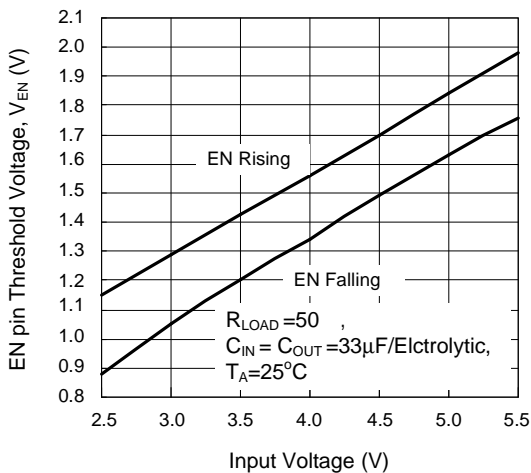

Turn-Off Leakage Current vs. Junction Temperature

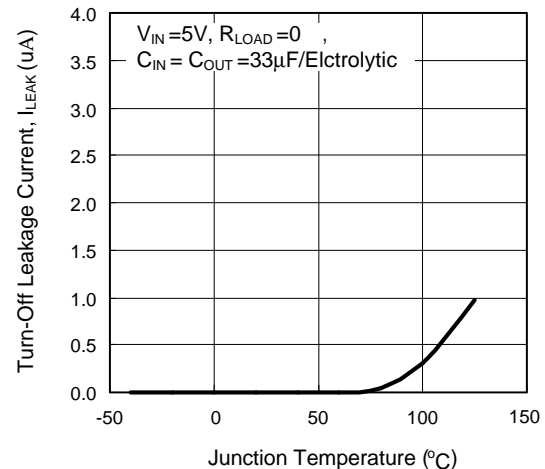

Typical Operating Characteristics

OCB Deglitch Time vs. Junction Temperature

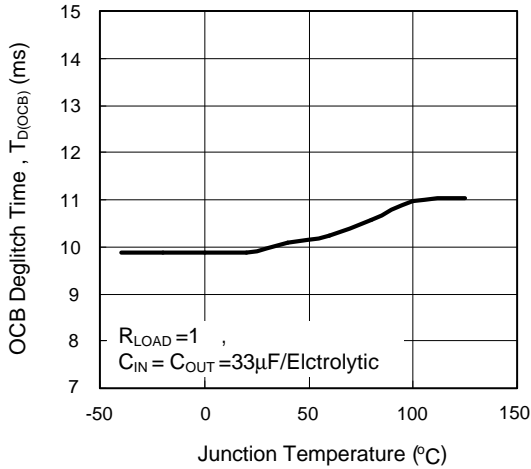

OCB Deglitch Time vs. Input Voltage

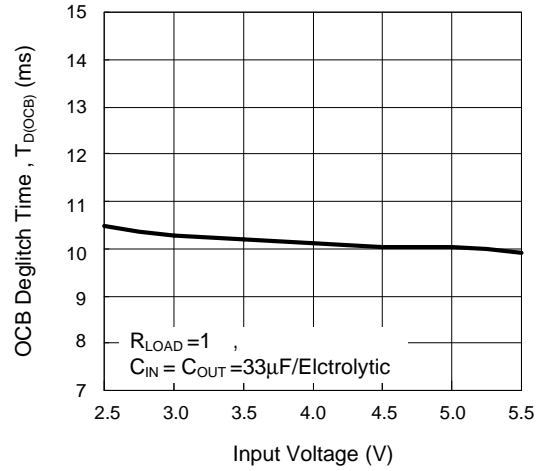

UVLO Threshold Voltage vs. Junction Temperature

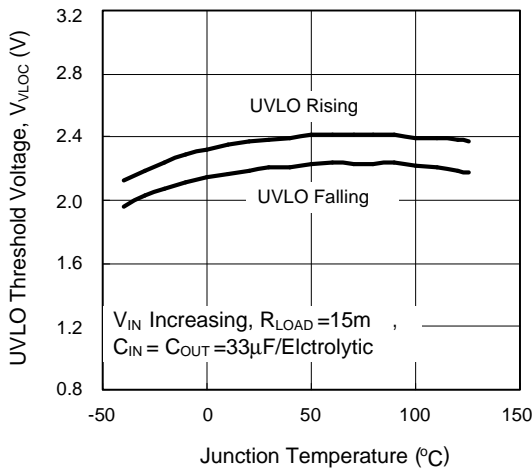

Output Voltage vs. Output Current

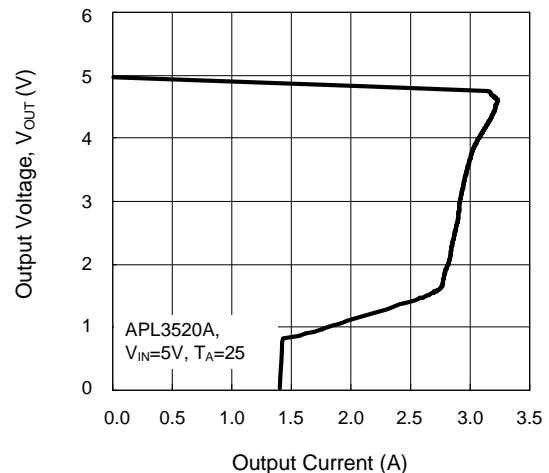

Turn-On Rising Time vs. Junction Temperature

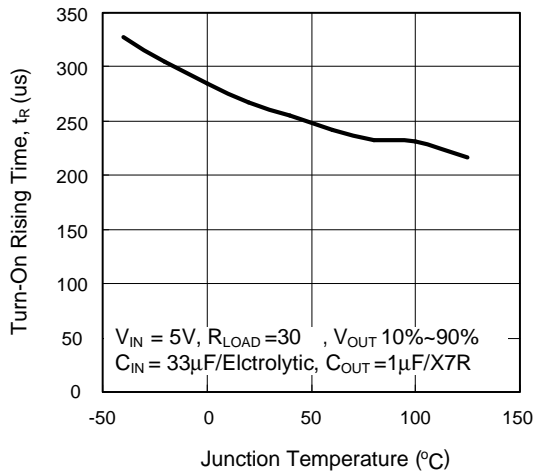

Output Voltage vs. Output Current

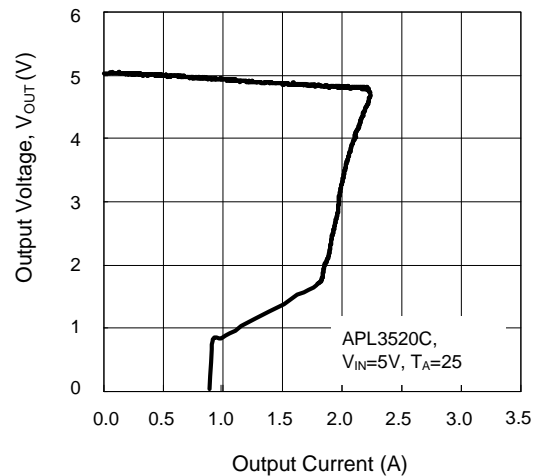

Operating Waveforms

The test condition is $V_{IN}=5V$, $T_A=25^\circ C$ unless otherwise specified.

Turn On Response

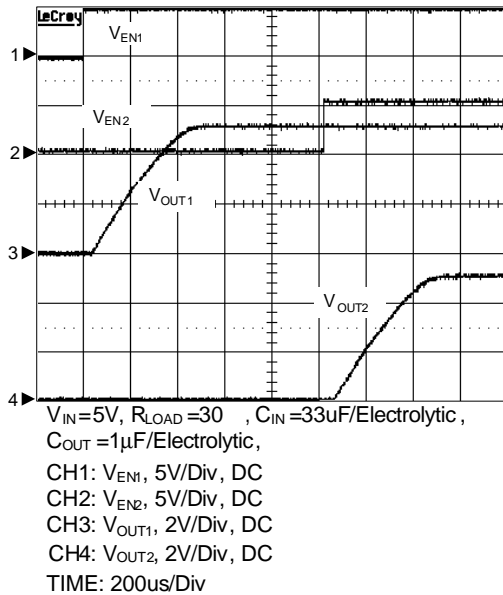

Turn Off Response

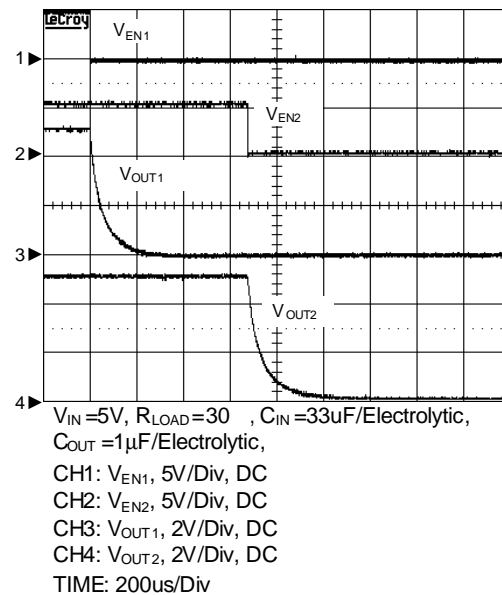

UVLO at Rising

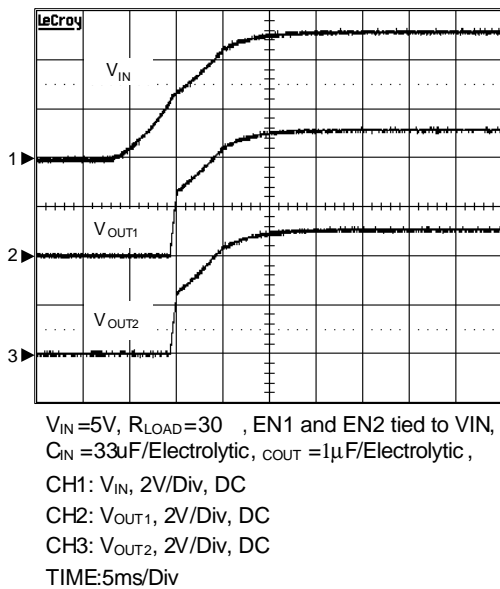

UVLO at Falling

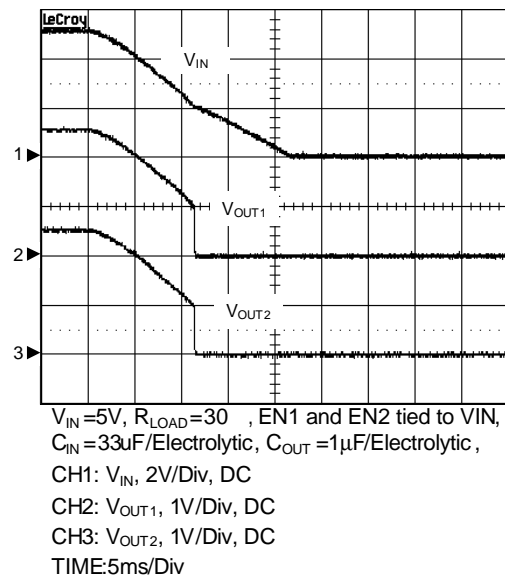

Operating Waveforms

The test condition is $V_{IN}=5V$, $T_A = 25^\circ C$ unless otherwise specified.

OCB Response during Short Circuit

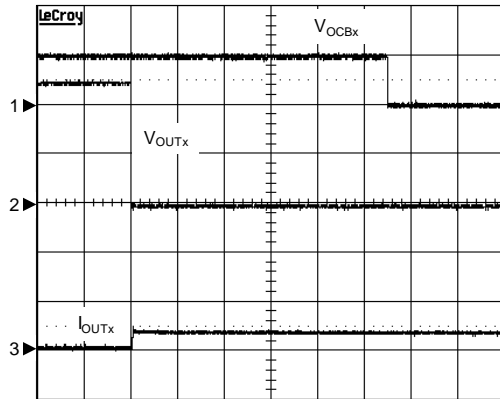

$V_{IN}=5V$, V_{OUTx} switched into ground,
 $C_{IN}=C_{OUT}=33\mu F$ /Electrolytic
 CH1: V_{OCBx} , 5V/Div, AC
 CH2: V_{OUTx} , 2V/Div, DC
 CH3: I_{OUTx} , 5A/Div, DC
 TIME: 2ms/Div

OCB Response during Over Load

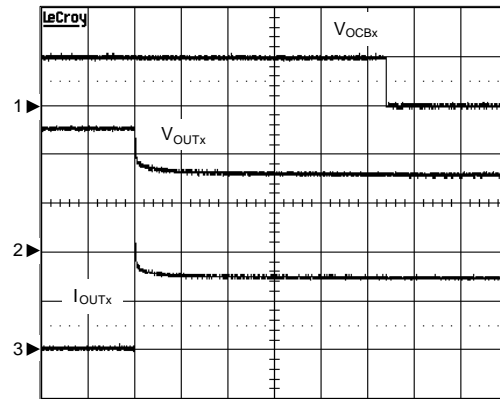

$V_{IN}=5V$, $R_{LOAD}=1 \Omega$ touches V_{OUTx} ,
 $C_{IN}=C_{OUT}=33\mu F$ /Electrolytic
 CH1: V_{OCBx} , 5V/Div, AC
 CH2: V_{OUTx} , 2V/Div, DC
 CH3: I_{OUTx} , 2A/Div, DC
 TIME: 2ms/Div

OCB Response with Ramped Load

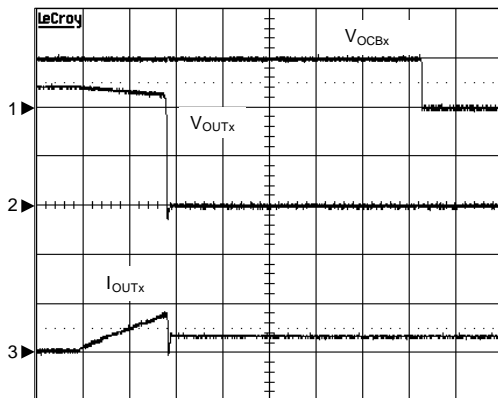

$V_{IN}=5V$, $C_{IN}=C_{OUT}=33\mu F$ /Electrolytic
 CH1: V_{OCBx} , 5V/Div, AC
 CH2: V_{OUTx} , 2V/Div, DC
 CH3: I_{OUT} , 5A/Div, DC
 TIME: 2ms/Div

Load-Transient

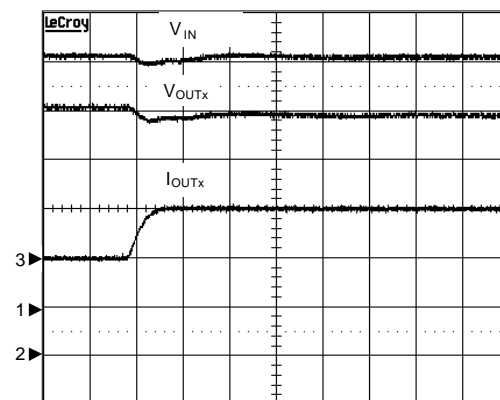

$V_{IN}=5V$, $I_{OUT}=0$ to 2A, C_{IN}
 $=C_{OUT}=33\mu F$ /Electrolytic
 CH1: V_{IN} , 2V/Div, DC
 CH2: V_{OUTx} , 1V/Div, DC
 CH3: I_{OUT} , 2A/Div, DC
 TIME: 20 μs /Div

Block Diagram

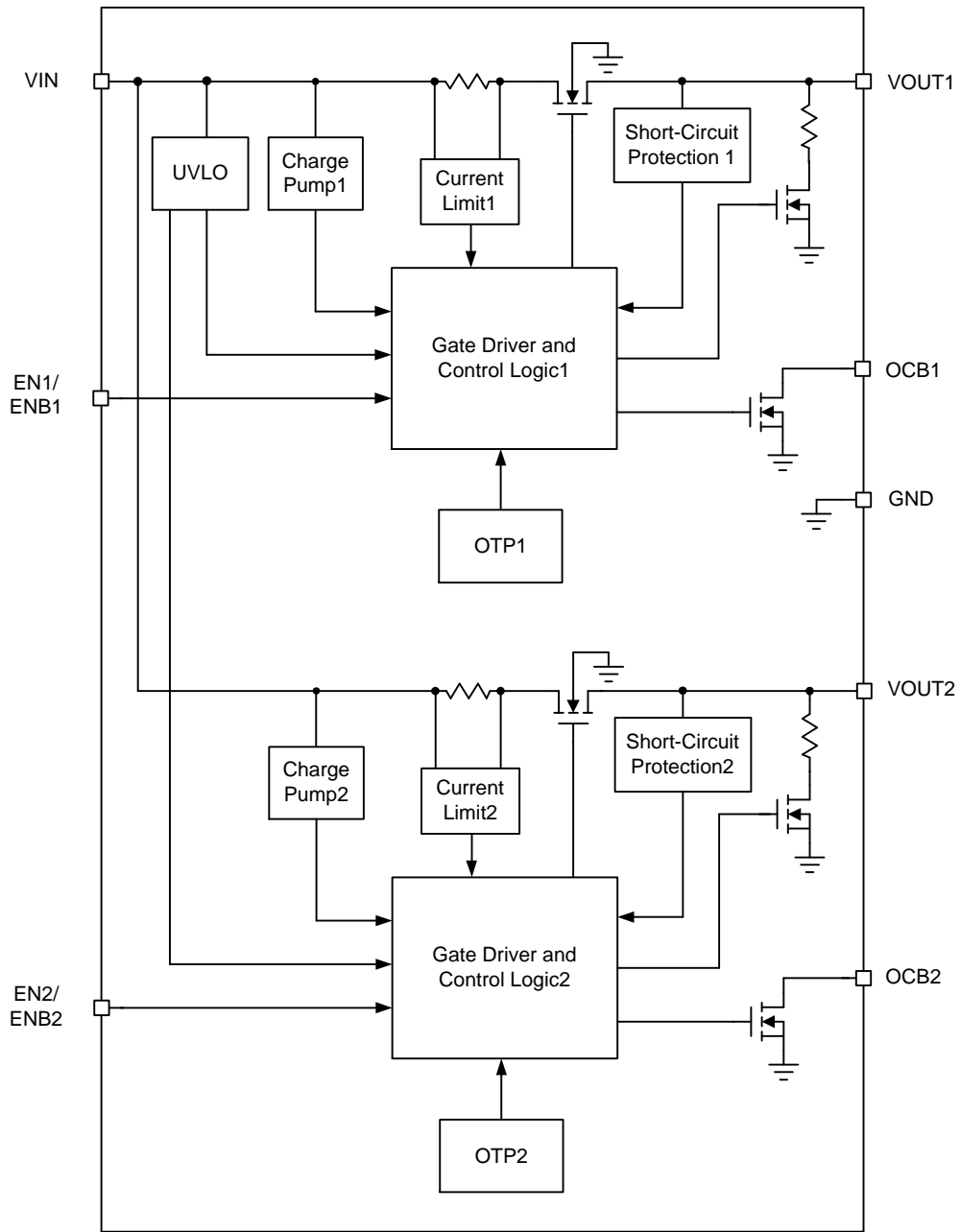

Typical Application Circuit

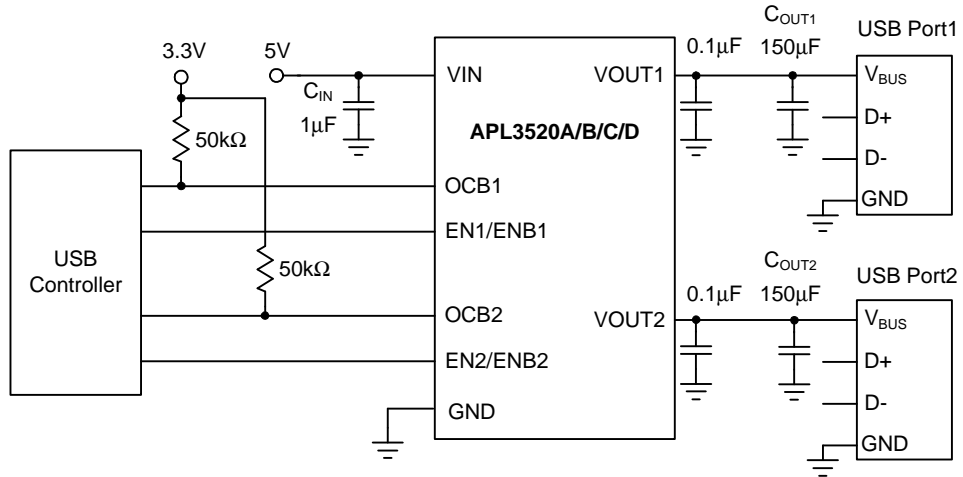

Function Description

VIN Under-Voltage Lockout (UVLO)

The APL3520 series of power switches have a built-in under-voltage lockout circuit to keep the output shutting off and discharging through an internal resistor until internal circuitry is operating properly. The UVLO circuit has hysteresis and a de-glitch feature so that it will typically ignore undershoot transients on the input. When input voltage exceeds the UVLO threshold, the output voltage starts a soft-start to reduce the inrush current.

Power Switch

The power switches are N-channel MOSFETs with low $R_{DS(ON)}$. The internal power MOSFETs do not have the body diode. When IC is off, the MOSFETs prevent current flowing from the VOUTx back to VIN and VIN to VOUTx.

Current-Limit Protection

The APL3520 series of power switches provide the current-limit protection function. During current limit, the devices limit output current at current limit threshold. For reliable operation, the device should not be operated in current limit for extended period.

Short-Circuit Protection

When the output voltage drops below 1.5V, which is caused by an over-load or a short-circuit, the devices limit the output current down to a safe level. The short-circuit current limit is used to reduce the power dissipation during short-circuit conditions. If the junction temperature reaches over-temperature threshold, the device will enter the thermal shutdown.

OCB Output

The APL3520 series of power switches provide an open-drain output to indicate that a fault has occurred. When any of current limit or over-temperature protection occurs for a deglitch time of $t_{D(OCB)}$, the OCB1/OCB2 goes low. Since the OCB1/OCB2 pin is an open-drain output, connecting a resistor to a pull high voltage is necessary.

Enable/Disable

Pull the ENB1/ENB2 above 2V or EN1/EN2 below 0.8V will disable the device, and pull ENB1/ENB2 pin below 0.8V or EN1/EN2 above 2V will enable the device. When the IC is disabled, the supply current is reduced to less

than 1 μ A. The enable input is compatible with both TTL and CMOS logic levels. The EN1/EN2 or ENB1/ENB2 pin cannot be left floating.

Over-Temperature Protection

When the junction temperature exceeds 140°C, the internal thermal sense circuit turns off the power FET and allows the device to cool down. When the device's junction temperature cools by 20°C, the internal thermal sense circuit will enable the device, resulting in a pulsed output during continuous thermal protection. Thermal protection is designed to protect the IC in the event of over temperature conditions. For normal operation, the junction temperature cannot exceed $T_J=+125^\circ\text{C}$.

Application Information (Cont.)

Recommended Minimum Footprint

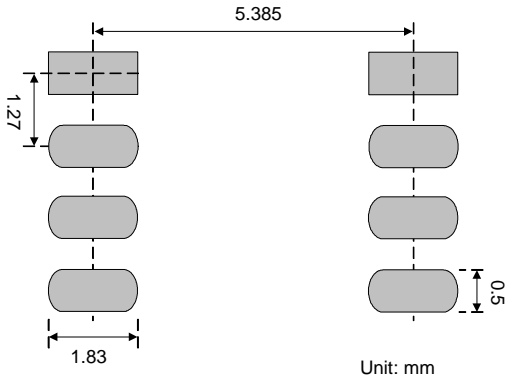

SOP-8

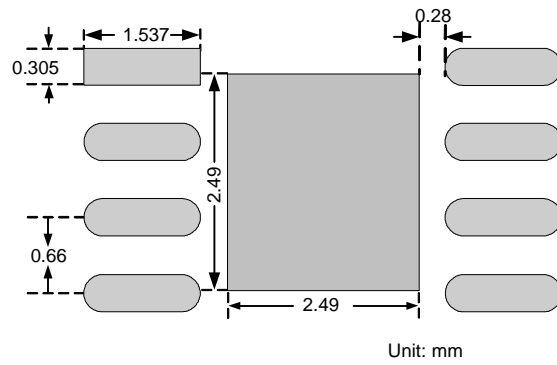

MSOP-8P

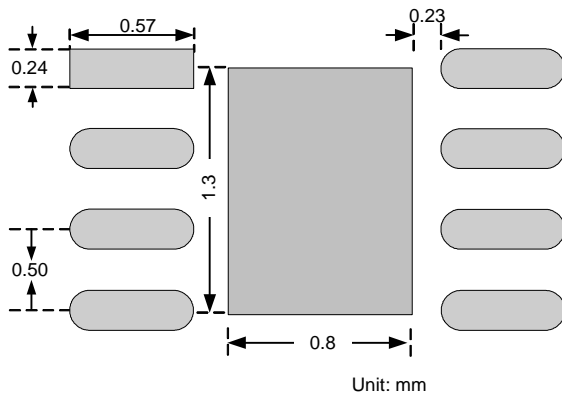

TDFN2X2-8

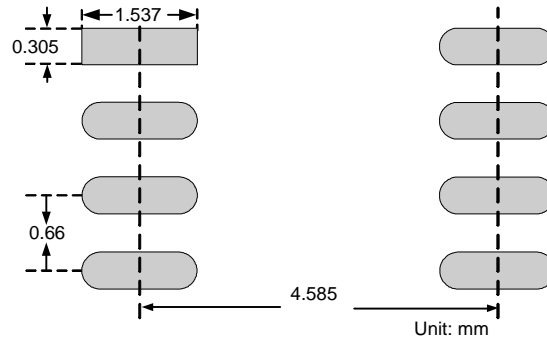

MSOP-8

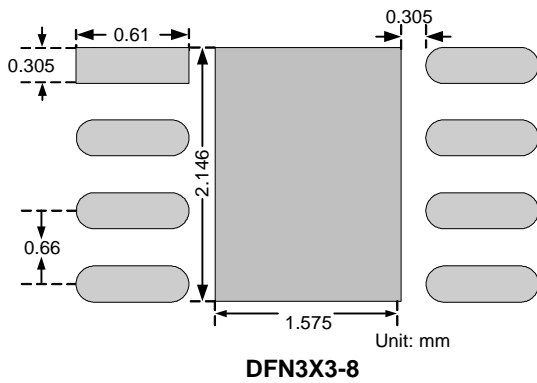

DFN3X3-8

Package Information

SOP-8

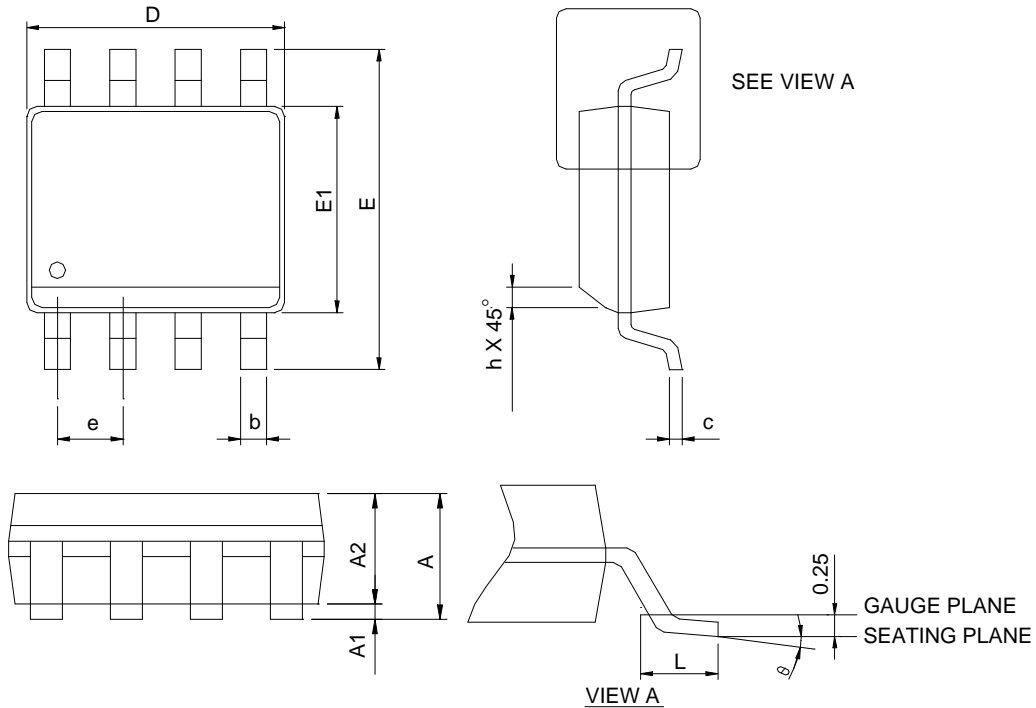

SYMBOL	SOP-8			
	MILLIMETERS		INCHES	
	MIN.	MAX.	MIN.	MAX.
A		1.75		0.069
A1	0.10	0.25	0.004	0.010
A2	1.25		0.049	
b	0.31	0.51	0.012	0.020
c	0.17	0.25	0.007	0.010
D	4.80	5.00	0.189	0.197
E	5.80	6.20	0.228	0.244
E1	3.80	4.00	0.150	0.157
e	1.27 BSC		0.050 BSC	
h	0.25	0.50	0.010	0.020
L	0.40	1.27	0.016	0.050
θ	0°	8°	0°	8°

- Note: 1. Follow JEDEC MS-012 AA.
 2. Dimension “D” does not include mold flash, protrusions or gate burrs. Mold flash, protrusion or gate burrs shall not exceed 6 mil per side.
 3. Dimension “E” does not include inter-lead flash or protrusions. Inter-lead flash and protrusions shall not exceed 10 mil per side.

Package Information

MSOP-8

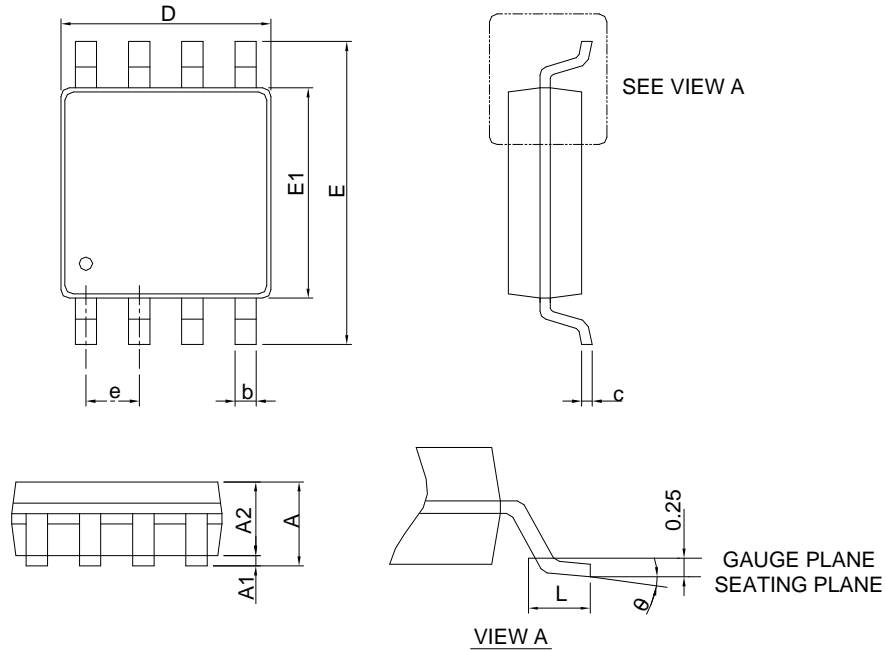

DIMENSIONS	MSOP-8			
	MILLIMETERS		INCHES	
	MIN.	MAX.	MIN.	MAX.
A		1.10		0.043
A1	0.00	0.15	0.000	0.006
A2	0.75	0.95	0.030	0.037
b	0.22	0.38	0.009	0.015
c	0.08	0.23	0.003	0.009
D	2.90	3.10	0.114	0.122
E	4.70	5.10	0.185	0.201
E1	2.90	3.10	0.114	0.122
e	0.65 BSC		0.026 BSC	
L	0.40	0.80	0.016	0.031
θ	0°	8°	0°	8°

- Note: 1. Follow JEDEC MO-187 AA.
 2. Dimension " D " does not include mold flash, protrusions or gate burrs. Mold flash, protrusion or gate burrs shall not exceed 6 mil per side.
 3. Dimension " E1 " does not include inter-lead flash or protrusions. Inter-lead flash and protrusions shall not exceed 5 mil per side.

Package Information

MSOP-8P

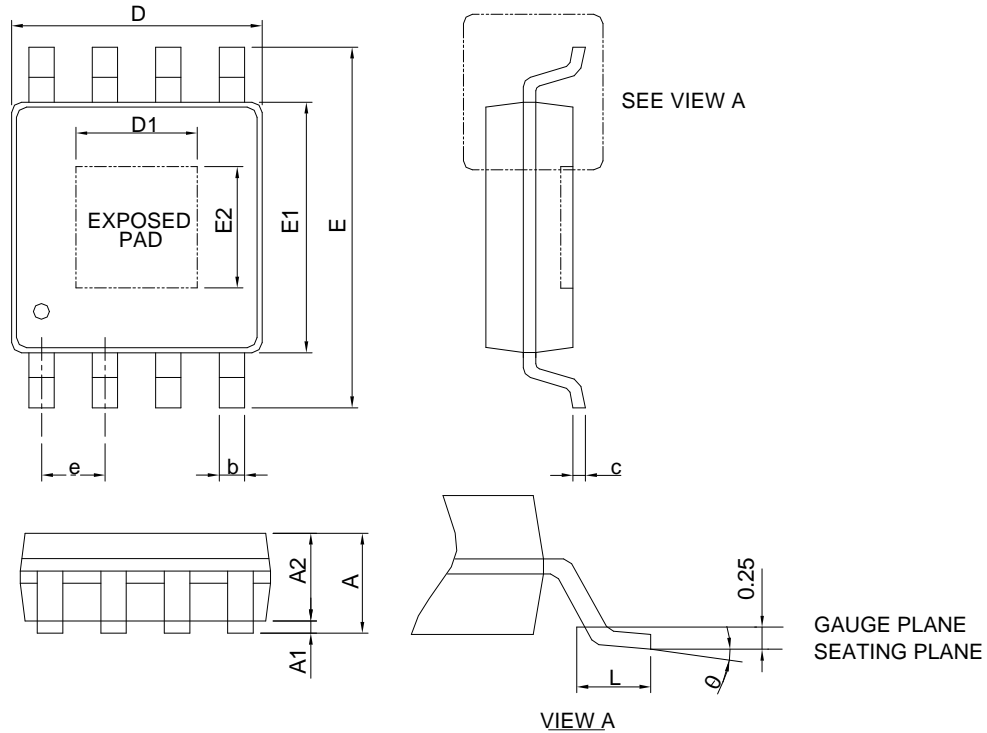

SYMBOL	MSOP-8P			
	MILLIMETERS		INCHES	
	MIN.	MAX.	MIN.	MAX.
A		1.10		0.043
A1	0.00	0.15	0.000	0.006
A2	0.75	0.95	0.030	0.037
b	0.22	0.38	0.009	0.015
c	0.08	0.23	0.003	0.009
D	2.90	3.10	0.114	0.122
D1	1.50	2.50	0.059	0.098
E	4.70	5.10	0.185	0.201
E1	2.90	3.10	0.114	0.122
E2	1.50	2.50	0.059	0.098
e	0.65 BSC		0.026 BSC	
L	0.40	0.80	0.016	0.031
θ	0°	8°	0°	8°

- Note: 1. Follow JEDEC MO-187 AA-T
 2. Dimension " D " does not include mold flash, protrusions or gate burrs. Mold flash, protrusion or gate burrs shall not flash or protrusions.
 3. Dimension " E1 " does not include inter-lead flash or protrusions. Inter-lead flash and protrusions shall not exceed 6 mil per side.

Package Information

DFN3x3-8

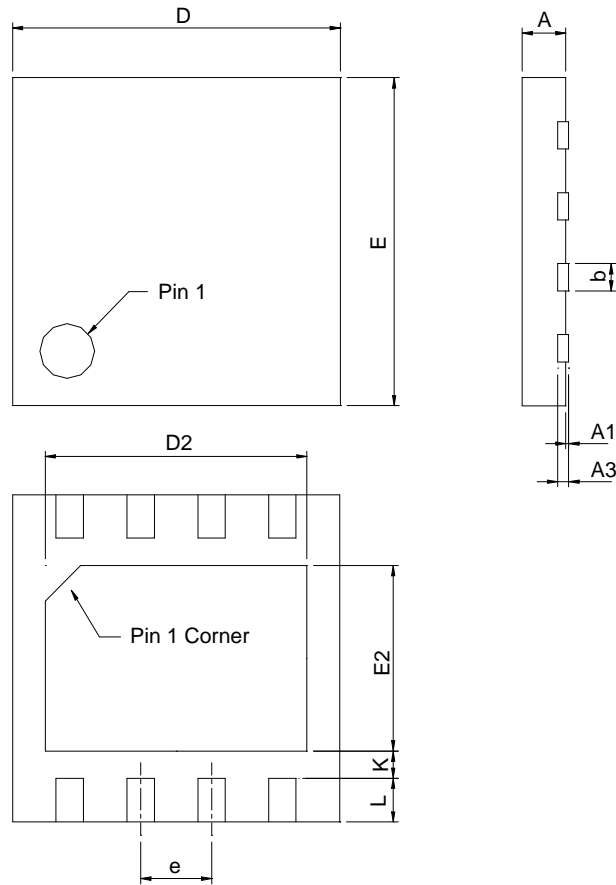

SYMBOL	DFN3x3-8			
	MILLIMETERS		INCHES	
	MIN.	MAX.	MIN.	MAX.
A	0.80	1.00	0.031	0.039
A1	0.00	0.05	0.000	0.002
A3	0.20 REF		0.008 REF	
b	0.25	0.35	0.010	0.014
D	2.90	3.10	0.114	0.122
D2	1.90	2.40	0.075	0.094
E	2.90	3.10	0.114	0.122
E2	1.40	1.75	0.055	0.069
e	0.65 BSC		0.026 BSC	
L	0.30	0.50	0.012	0.020
K	0.20		0.008	

Carrier Tape & Reel Dimensions

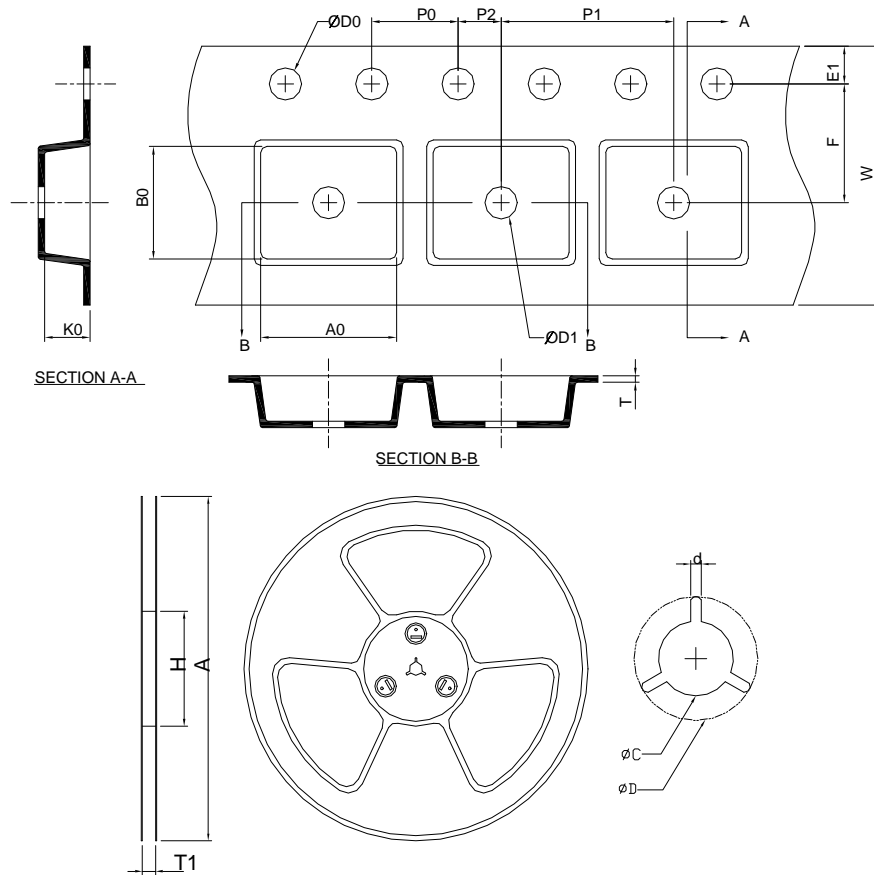

Application	A	H	T1	C	d	D	W	E1	F
SOP-8	330.0 ±0.00	50 MIN.	12.4+2.00 -0.00	13.0+0.50 -0.20	1.5 MIN.	20.2 MIN.	12.0 ±0.30	1.75 ±0.10	5.5 ±0.05
	P0	P1	P2	D0	D1	T	A0	B0	K0
	4.0 ±0.10	8.0 ±0.10	2.0 ±0.05	1.5+0.10 -0.00	1.5 MIN.	0.6+0.00 -0.40	6.40 ±0.20	5.20 ±0.20	2.10 ±0.20
MSOP-8(P)	330.0 ±0.00	50 MIN.	12.4+2.00 -0.00	13.0+0.50 -0.20	1.5 MIN.	20.2 MIN.	12.0 ±0.30	1.75 ±0.10	5.5 ±0.05
	P0	P1	P2	D0	D1	T	A0	B0	K0
	4.00 ±0.10	8.00 ±0.10	2.00 ±0.05	1.5+0.10 -0.00	1.5 MIN.	0.6+0.00 -0.40	5.30 ±0.20	3.30 ±0.20	1.40 ±0.20
TDFN2x2-8	178.0 ±0.00	50 MIN.	8.4+2.00 -0.00	13.0+0.50 -0.20	1.5 MIN.	20.2 MIN.	8.0 ±0.20	1.75 ±0.10	3.50 ±0.05
	P0	P1	P2	D0	D1	T	A0	B0	K0
	4.0 ±0.10	4.0 ±0.10	2.0 ±0.05	1.5+0.10 -0.00	1.5 MIN.	0.6+0.00 -0.4	2.35 ±0.20	2.35 ±0.20	1.30 ±0.20
DFN3x3-8	178.0 ±0.00	50 MIN.	12.4+2.00 -0.00	13.0+0.50 -0.20	1.5 MIN.	20.2 MIN.	12.0 ±0.30	1.75 ±0.10	5.5 ±0.05
	P0	P1	P2	D0	D1	T	A0	B0	K0
	4.0 ±0.10	8.0 ±0.10	2.0 ±0.05	1.5+0.10 -0.00	1.5 MIN.	0.6+0.00 -0.40	3.30 ±0.20	3.30 ±0.20	1.30 ±0.20

Devices Per Unit

Package Type	Unit	Quantity
SOP-8	Tape & Reel	2500
MSOP-8(P)	Tape & Reel	3000
TDFN2x2-8	Tape & Reel	3000
DFN3x3-8	Tape & Reel	3000

Taping Direction Information

SOP-8

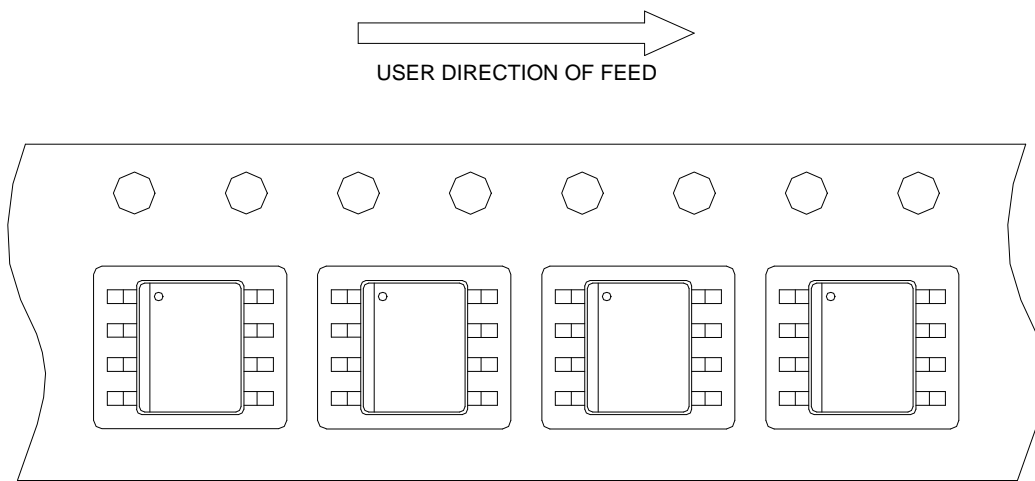

MSOP-8(P)

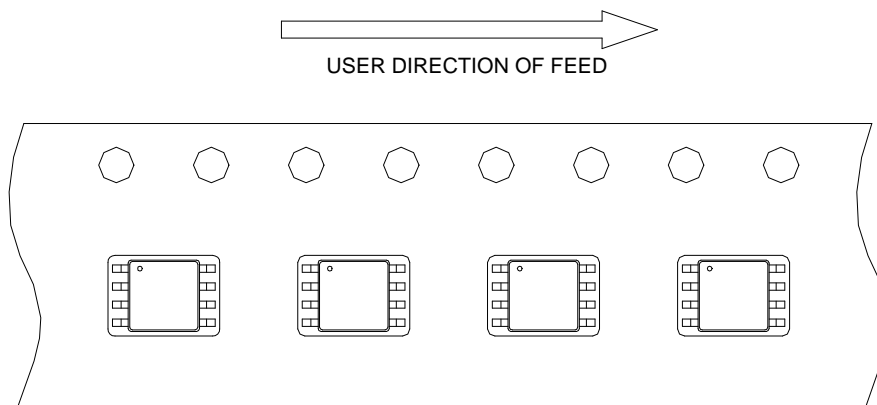

Taping Direction Information (Cont.)

TDFN2x2-8

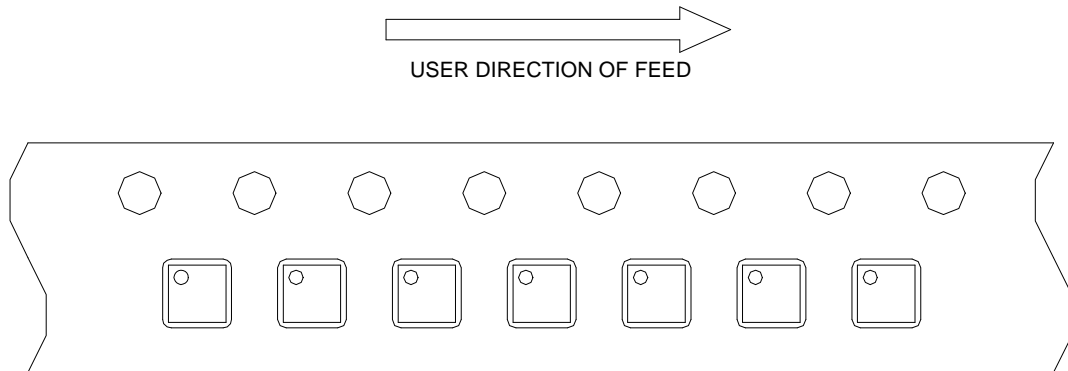

DFN3x3-8

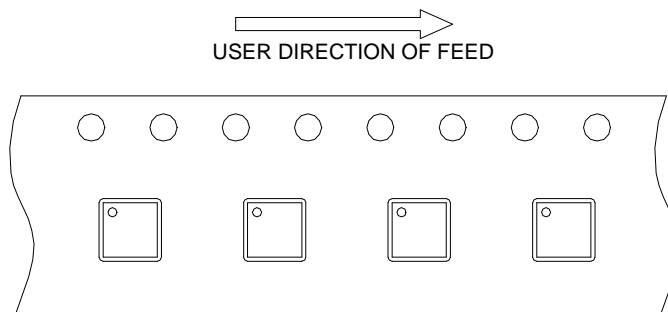

Classification Profile

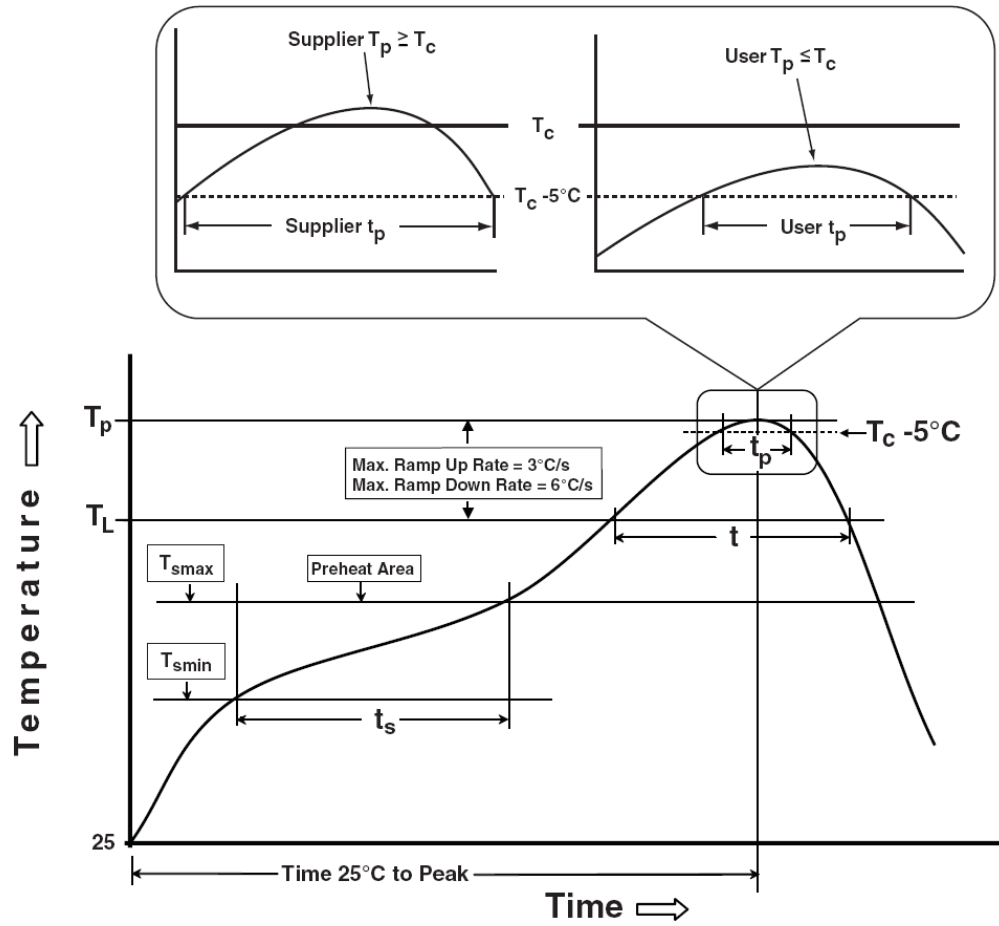

Classification Reflow Profiles

Profile Feature	Sn-Pb Eutectic Assembly	Pb-Free Assembly
Preheat & Soak Temperature min (T_{smin}) Temperature max (T_{smax}) Time (T_{smin} to T_{smax}) (t_s)	100 °C 150 °C 60-120 seconds	150 °C 200 °C 60-120 seconds
Average ramp-up rate (T_{smax} to T_p)	3 °C/second max.	3°C/second max.
Liquidous temperature (T_L) Time at liquidous (t_L)	183 °C 60-150 seconds	217 °C 60-150 seconds
Peak package body Temperature (T_p)*	See Classification Temp in table 1	See Classification Temp in table 2
Time (t_p)** within 5°C of the specified classification temperature (T_c)	20** seconds	30** seconds
Average ramp-down rate (T_p to T_{smax})	6 °C/second max.	6 °C/second max.
Time 25°C to peak temperature	6 minutes max.	8 minutes max.
* Tolerance for peak profile Temperature (T_p) is defined as a supplier minimum and a user maximum. ** Tolerance for time at peak profile temperature (t_p) is defined as a supplier minimum and a user maximum.		

Table 1. SnPb Eutectic Process – Classification Temperatures (T_c)

Package Thickness	Volume mm ³ <350	Volume mm ³ ≥350
<2.5 mm	235 °C	220 °C
≥2.5 mm	220 °C	220 °C

Table 2. Pb-free Process – Classification Temperatures (T_c)

Package Thickness	Volume mm ³ <350	Volume mm ³ 350-2000	Volume mm ³ >2000
<1.6 mm	260 °C	260 °C	260 °C
1.6 mm – 2.5 mm	260 °C	250 °C	245 °C
≥2.5 mm	250 °C	245 °C	245 °C

Reliability Test Program

Test item	Method	Description
SOLDERABILITY	JESD-22, B102	5 Sec, 245°C
HOLT	JESD-22, A108	1000 Hrs, Bias @ $T_j=125^{\circ}C$
PCT	JESD-22, A102	168 Hrs, 100%RH, 2atm, 121°C
TCT	JESD-22, A104	500 Cycles, -65°C~150°C
HBM	MIL-STD-883-3015.7	VHBM 2KV
MM	JESD-22, A115	VMM 200V
Latch-Up	JESD 78	10ms, 1_{tr} 100mA

Customer Service

Anpec Electronics Corp.

Head Office :

No.6, Dusing 1st Road, SBIP,
Hsin-Chu, Taiwan, R.O.C.
Tel : 886-3-5642000
Fax : 886-3-5642050

Taipei Branch :

2F, No. 11, Lane 218, Sec 2 Jhongsing Rd.,
Sindian City, Taipei County 23146, Taiwan
Tel : 886-2-2910-3838
Fax : 886-2-2917-3838

