

The S-82F1B Series is a protection IC for lithium-ion / lithium polymer rechargeable batteries and includes high-accuracy voltage detection circuits and delay circuits. It is suitable for protecting 1-cell lithium-ion / lithium polymer rechargeable battery packs from overcharge, overdischarge, and overcurrent.

By using an external overcurrent detection resistor, the S-82F1B Series realizes high-accuracy overcurrent protection with less effect from temperature change.

## ■ Features

- High-accuracy voltage detection circuit
 

Overcharge detection voltage	3.500 V to 4.600 V (5 mV step)	Accuracy ±15 mV
Overcharge release voltage	3.100 V to 4.600 V <sup>*1</sup>	Accuracy ±50 mV
Overdischarge detection voltage	2.000 V to 3.000 V (10 mV step)	Accuracy ±50 mV
Overdischarge release voltage	2.000 V to 3.400 V <sup>*2</sup>	Accuracy ±75 mV
Discharge overcurrent detection voltage 1	0.003 V to 0.100 V (0.5 mV step)	Accuracy ±1.5 mV
Discharge overcurrent detection voltage 2	0.010 V to 0.100 V (1 mV step)	Accuracy ±3 mV
Load short-circuiting detection voltage	0.020 V to 0.100 V (1 mV step)	Accuracy ±5 mV
Charge overcurrent detection voltage	-0.100 V to -0.003 V (0.5 mV step)	Accuracy ±1.5 mV
- Detection delay times are generated only by an internal circuit (external capacitors are unnecessary)
- Discharge overcurrent control function
  - Release condition of discharge overcurrent status: Load disconnection
  - Release voltage of discharge overcurrent status:  $V_{RIOV} = V_{DD} \times 0.80$  typ.
- 0 V battery charge function is selectable: Available, unavailable
- Power-down function is selectable: Available, unavailable
- High-withstand voltage: VM pin and CO pin: Absolute maximum rating 28 V
- Wide operation temperature range: Ta = -40°C to +85°C
- Low current consumption
  - During operation: 2.0 μA typ., 4.0 μA max. (Ta = +25°C)
  - During power-down: 50 nA max. (Ta = +25°C)
  - During overdischarge: 0.5 μA max. (Ta = +25°C)
- Lead-free (Sn 100%), halogen-free

\*1. Overcharge release voltage = Overcharge detection voltage – Overcharge hysteresis voltage  
(Overcharge hysteresis voltage can be selected as 0 V or from a range of 0.1 V to 0.4 V in 50 mV step.)

\*2. Overdischarge release voltage = Overdischarge detection voltage + Overdischarge hysteresis voltage  
(Overdischarge hysteresis voltage can be selected as 0 V or from a range of 0.1 V to 0.7 V in 100 mV step.)

## ■ Applications

- Lithium-ion rechargeable battery pack
- Lithium polymer rechargeable battery pack

## ■ Package

- SNT-6A

■ **Block Diagram**

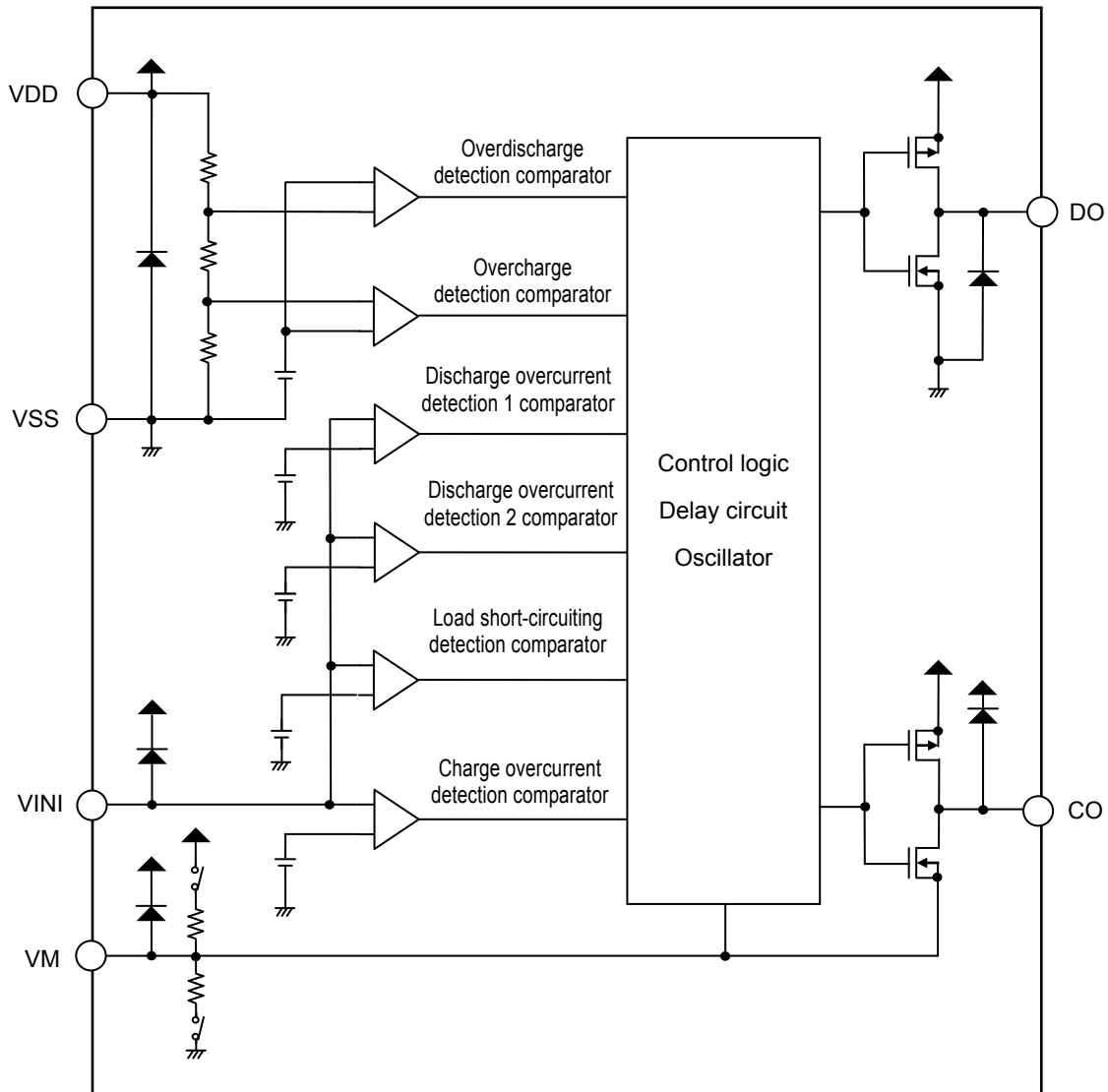
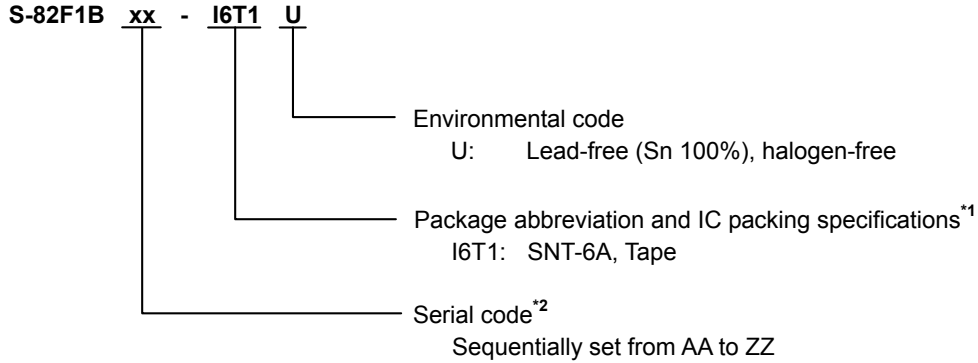

Figure 1

**■ Product Name Structure**

**1. Product name**



- \*1. Refer to the tape drawing.
- \*2. Refer to "3. Product name list".

**2. Package**

**Table 1 Package Drawing Codes**

Package Name	Dimension	Tape	Reel	Land
SNT-6A	PG006-A-P-SD	PG006-A-C-SD	PG006-A-R-SD	PG006-A-L-SD

**3. Product name list**

**3. 1 SNT-6A**

**Table 2 (1 / 2)**

Product Name	Overcharge Detection Voltage [V <sub>CU</sub> ]	Overcharge Release Voltage [V <sub>CL</sub> ]	Overdischarge Detection Voltage [V <sub>DL</sub> ]	Overdischarge Release Voltage [V <sub>DU</sub> ]	Discharge Overcurrent Detection Voltage 1 [V <sub>DIOV1</sub> ]	Discharge Overcurrent Detection Voltage 2 [V <sub>DIOV2</sub> ]	Load Short-circuiting Detection Voltage [V <sub>SHORT</sub> ]	Charge Overcurrent Detection Voltage [V <sub>CIOV</sub> ]
S-82F1BAD-I6T1U	4.475 V	4.275 V	2.500 V	2.800 V	0.016 V	–	0.040 V	–0.016 V
S-82F1BAE-I6T1U	4.475 V	4.275 V	2.500 V	2.900 V	0.015 V	–	0.032 V	–0.015 V
S-82F1BAF-I6T1U	4.520 V	4.320 V	2.300 V	2.500 V	0.015 V	–	0.036 V	–0.015 V
S-82F1BAG-I6T1U	4.475 V	4.275 V	2.500 V	2.900 V	0.015 V	–	0.040 V	–0.015 V
S-82F1BAH-I6T1U	4.520 V	4.320 V	2.300 V	2.500 V	0.015 V	–	0.046 V	–0.015 V
S-82F1BAK-I6T1U	4.475 V	4.275 V	2.500 V	2.800 V	0.016 V	–	0.040 V	–0.016 V
S-82F1BAN-I6T1U	4.495 V	4.295 V	2.500 V	2.900 V	0.014 V	–	0.040 V	–0.015 V
S-82F1BAO-I6T1U	4.540 V	4.340 V	2.300 V	2.500 V	0.014 V	–	0.050 V	–0.015 V
S-82F1BAQ-I6T1U	4.445 V	4.295 V	2.350 V	2.550 V	0.0105 V	0.015 V	0.042 V	–0.015 V

**Table 2 (2 / 2)**

Product Name	Delay Time Combination <sup>*1</sup>	0 V Battery Charge Function <sup>*2</sup>	Power-down Function <sup>*3</sup>
S-82F1BAD-I6T1U	(1)	Unavailable	Unavailable
S-82F1BAE-I6T1U	(2)	Unavailable	Unavailable
S-82F1BAF-I6T1U	(3)	Unavailable	Unavailable
S-82F1BAG-I6T1U	(4)	Unavailable	Unavailable
S-82F1BAH-I6T1U	(5)	Unavailable	Unavailable
S-82F1BAK-I6T1U	(1)	Available	Unavailable
S-82F1BAN-I6T1U	(2)	Unavailable	Unavailable
S-82F1BAO-I6T1U	(3)	Unavailable	Unavailable
S-82F1BAQ-I6T1U	(6)	Available	Unavailable

\*1. Refer to **Table 3** about the details of the delay time combinations.

\*2. 0 V battery charge function "available" / "unavailable" is selectable.

\*3. Power-down function "available" / "unavailable" is selectable.

**Remark** Please contact our sales office for the products with detection voltage value other than those specified above.

**Table 3**

Delay Time Combination	Overcharge Detection Delay Time [t <sub>CU</sub> ]	Overdischarge Detection Delay Time [t <sub>DL</sub> ]	Discharge Overcurrent Detection Delay Time 1 [t <sub>DIOV1</sub> ]	Discharge Overcurrent Detection Delay Time 2 [t <sub>DIOV2</sub> ]	Load Short-circuiting Detection Delay Time [t <sub>SHORT</sub> ]	Charge Overcurrent Detection Delay Time [t <sub>CIOV</sub> ]
(1)	1.0 s	32 ms	16 ms	–	280 μs	16 ms
(2)	1.0 s	64 ms	64 ms	–	280 μs	16 ms
(3)	1.0 s	64 ms	128 ms	–	280 μs	64 ms
(4)	1.0 s	64 ms	32 ms	–	280 μs	16 ms
(5)	1.0 s	64 ms	64 ms	–	280 μs	64 ms
(6)	1.0 s	64 ms	3.75 s	16 ms	280 μs	16 ms

**Remark** The delay times can be changed within the range listed in **Table 4**. For details, please contact our sales office.

**Table 4**

Delay Time	Symbol	Selection Range						Remark
Overcharge detection delay time	t <sub>CU</sub>	256 ms	512 ms	1.0 s	–	–	–	Select a value from the left.
Overdischarge detection delay time	t <sub>DL</sub>	32 ms	64 ms	128 ms	–	–	–	Select a value from the left.
Discharge overcurrent detection delay time 1	t <sub>DIOV1</sub>	8 ms	16 ms	32 ms	64 ms	128 ms	256 ms	Select a value from the left.
		512 ms	1.0 s	2.0 s	3.0 s	3.75 s	4.0 s	
Discharge overcurrent detection delay time 2	t <sub>DIOV2</sub>	4 ms	8 ms	16 ms	32 ms	64 ms	128 ms	Select a value from the left.
Load short-circuiting detection delay time	t <sub>SHORT</sub>	280 μs	530 μs	–	–	–	–	Select a value from the left.
Charge overcurrent detection delay time	t <sub>CIOV</sub>	4 ms	8 ms	16 ms	32 ms	64 ms	128 ms	Select a value from the left.

### ■ Pin Configuration

#### 1. SNT-6A

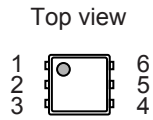

**Figure 2**

**Table 5**

Pin No.	Symbol	Description
1	VM	Input pin for external negative voltage
2	CO	Connection pin of charge control FET gate (CMOS output)
3	DO	Connection pin of discharge control FET gate (CMOS output)
4	VSS	Input pin for negative power supply
5	VDD	Input pin for positive power supply
6	VINI	Overcurrent detection pin

■ **Absolute Maximum Ratings**

**Table 6**

(Ta = +25°C unless otherwise specified)

Item	Symbol	Applied Pin	Absolute Maximum Rating	Unit
Input voltage between VDD pin and VSS pin	$V_{DS}$	VDD	$V_{SS} - 0.3$ to $V_{SS} + 6$	V
VINI pin input voltage	$V_{VINI}$	VINI	$V_{DD} - 6$ to $V_{DD} + 0.3$	V
VM pin input voltage	$V_{VM}$	VM	$V_{DD} - 28$ to $V_{DD} + 0.3$	V
DO pin output voltage	$V_{DO}$	DO	$V_{SS} - 0.3$ to $V_{DD} + 0.3$	V
CO pin output voltage	$V_{CO}$	CO	$V_{DD} - 28$ to $V_{DD} + 0.3$	V
Operation ambient temperature	$T_{opr}$	–	–40 to +85	°C
Storage temperature	$T_{stg}$	–	–55 to +125	°C

**Caution** The absolute maximum ratings are rated values exceeding which the product could suffer physical damage. These values must therefore not be exceeded under any conditions.

■ **Thermal Resistance Value**

**Table 7**

Item	Symbol	Condition	Min.	Typ.	Max.	Unit	
Junction-to-ambient thermal resistance*1	$\theta_{JA}$	SNT-6A	Board A	–	224	–	°C/W
			Board B	–	176	–	°C/W
			Board C	–	–	–	°C/W
			Board D	–	–	–	°C/W
			Board E	–	–	–	°C/W

\*1. Test environment: compliance with JEDEC STANDARD JESD51-2A

**Remark** Refer to "■ Power Dissipation" and "Test Board" for details.

# BATTERY PROTECTION IC FOR 1-CELL PACK S-82F1B Series

Rev.3.1\_00

## ■ Electrical Characteristics

1. Ta = +25°C

Table 8

(Ta = +25°C unless otherwise specified)

Item	Symbol	Condition	Min.	Typ.	Max.	Unit	Test Circuit
<b>Detection Voltage</b>							
Overcharge detection voltage	V <sub>CU</sub>	–	V <sub>CU</sub> – 0.015	V <sub>CU</sub>	V <sub>CU</sub> + 0.015	V	1
Overcharge release voltage	V <sub>CL</sub>	V <sub>CL</sub> ≠ V <sub>CU</sub>	V <sub>CL</sub> – 0.050	V <sub>CL</sub>	V <sub>CL</sub> + 0.050	V	1
		V <sub>CL</sub> = V <sub>CU</sub>	V <sub>CL</sub> – 0.020	V <sub>CL</sub>	V <sub>CL</sub> + 0.015	V	1
Overdischarge detection voltage	V <sub>DL</sub>	–	V <sub>DL</sub> – 0.050	V <sub>DL</sub>	V <sub>DL</sub> + 0.050	V	2
Overdischarge release voltage	V <sub>DU</sub>	V <sub>DL</sub> ≠ V <sub>DU</sub>	V <sub>DU</sub> – 0.075	V <sub>DU</sub>	V <sub>DU</sub> + 0.075	V	2
		V <sub>DL</sub> = V <sub>DU</sub>	V <sub>DU</sub> – 0.050	V <sub>DU</sub>	V <sub>DU</sub> + 0.050	V	2
Discharge overcurrent detection voltage 1	V <sub>DIOV1</sub>	–	V <sub>DIOV1</sub> – 0.0015	V <sub>DIOV1</sub>	V <sub>DIOV1</sub> + 0.0015	V	5
Discharge overcurrent detection voltage 2	V <sub>DIOV2</sub>	–	V <sub>DIOV2</sub> – 0.003	V <sub>DIOV2</sub>	V <sub>DIOV2</sub> + 0.003	V	2
Load short-circuiting detection voltage	V <sub>SHORT</sub>	–	V <sub>SHORT</sub> – 0.005	V <sub>SHORT</sub>	V <sub>SHORT</sub> + 0.005	V	2
Load short-circuiting detection voltage 2	V <sub>SHORT2</sub>	–	V <sub>DD</sub> – 1.2	V <sub>DD</sub> – 0.8	V <sub>DD</sub> – 0.5	V	2
Charge overcurrent detection voltage	V <sub>CIOV</sub>	–	V <sub>CIOV</sub> – 0.0015	V <sub>CIOV</sub>	V <sub>CIOV</sub> + 0.0015	V	2
Discharge overcurrent release voltage	V <sub>RIOV</sub>	V <sub>DD</sub> = 3.4 V	V <sub>DD</sub> × 0.77	V <sub>DD</sub> × 0.80	V <sub>DD</sub> × 0.83	V	5
<b>0 V Battery Charge Function</b>							
0 V battery charge starting charger voltage	V <sub>OCHA</sub>	0 V battery charge function "available"	0.7	1.1	1.5	V	4
0 V battery charge inhibition battery voltage	V <sub>OINH</sub>	0 V battery charge function "unavailable"	0.9	1.2	1.5	V	2
<b>Internal Resistance</b>							
Resistance between VDD pin and VM pin	R <sub>VMD</sub>	V <sub>DD</sub> = 1.8 V, V <sub>VM</sub> = 0 V	500	1250	2500	kΩ	3
Resistance between VM pin and VSS pin	R <sub>VMS</sub>	V <sub>DD</sub> = 3.4 V, V <sub>VM</sub> = 1.0 V	5	10	15	kΩ	3
<b>Input Voltage</b>							
Operation voltage between VDD pin and VSS pin	V <sub>DSOP1</sub>	–	1.5	–	6.0	V	–
Operation voltage between VDD pin and VM pin	V <sub>DSOP2</sub>	–	1.5	–	28	V	–
<b>Input Current</b>							
Current consumption during operation	I <sub>OPE</sub>	V <sub>DD</sub> = 3.4 V, V <sub>VM</sub> = 0 V	–	2.0	4.0	μA	3
Current consumption during power-down	I <sub>PDN</sub>	V <sub>DD</sub> = V <sub>VM</sub> = 1.5 V	–	–	0.05	μA	3
Current consumption during overdischarge	I <sub>OPEd</sub>	V <sub>DD</sub> = V <sub>VM</sub> = 1.5 V	–	–	0.5	μA	3
<b>Output Resistance</b>							
CO pin resistance "H"	R <sub>COH</sub>	–	5	10	20	kΩ	4
CO pin resistance "L"	R <sub>COL</sub>	–	5	10	20	kΩ	4
DO pin resistance "H"	R <sub>DOH</sub>	–	5	10	20	kΩ	4
DO pin resistance "L"	R <sub>DOL</sub>	–	1	2	4	kΩ	4
<b>Delay Time</b>							
Overcharge detection delay time	t <sub>CU</sub>	–	t <sub>CU</sub> × 0.7	t <sub>CU</sub>	t <sub>CU</sub> × 1.3	–	5
Overdischarge detection delay time	t <sub>DL</sub>	–	t <sub>DL</sub> × 0.7	t <sub>DL</sub>	t <sub>DL</sub> × 1.3	–	5
Discharge overcurrent detection delay time 1	t <sub>DIOV1</sub>	–	t <sub>DIOV1</sub> × 0.75	t <sub>DIOV1</sub>	t <sub>DIOV1</sub> × 1.25	–	5
Discharge overcurrent detection delay time 2	t <sub>DIOV2</sub>	–	t <sub>DIOV2</sub> × 0.7	t <sub>DIOV2</sub>	t <sub>DIOV2</sub> × 1.3	–	5
Load short-circuiting detection delay time	t <sub>SHORT</sub>	–	t <sub>SHORT</sub> × 0.7	t <sub>SHORT</sub>	t <sub>SHORT</sub> × 1.3	–	5
Charge overcurrent detection delay time	t <sub>CIOV</sub>	–	t <sub>CIOV</sub> × 0.7	t <sub>CIOV</sub>	t <sub>CIOV</sub> × 1.3	–	5

2. Ta = -20°C to +60°C\*1

**Table 9**

(Ta = -20°C to +60°C\*1 unless otherwise specified)

Item	Symbol	Condition	Min.	Typ.	Max.	Unit	Test Circuit
<b>Detection Voltage</b>							
Overcharge detection voltage	V <sub>CU</sub>	-	V <sub>CU</sub> - 0.020	V <sub>CU</sub>	V <sub>CU</sub> + 0.020	V	1
Overcharge release voltage	V <sub>CL</sub>	V <sub>CL</sub> ≠ V <sub>CU</sub>	V <sub>CL</sub> - 0.065	V <sub>CL</sub>	V <sub>CL</sub> + 0.057	V	1
		V <sub>CL</sub> = V <sub>CU</sub>	V <sub>CL</sub> - 0.025	V <sub>CL</sub>	V <sub>CL</sub> + 0.020	V	1
Overdischarge detection voltage	V <sub>DL</sub>	-	V <sub>DL</sub> - 0.060	V <sub>DL</sub>	V <sub>DL</sub> + 0.055	V	2
Overdischarge release voltage	V <sub>DU</sub>	V <sub>DL</sub> ≠ V <sub>DU</sub>	V <sub>DU</sub> - 0.085	V <sub>DU</sub>	V <sub>DU</sub> + 0.080	V	2
		V <sub>DL</sub> = V <sub>DU</sub>	V <sub>DU</sub> - 0.060	V <sub>DU</sub>	V <sub>DU</sub> + 0.055	V	2
Discharge overcurrent detection voltage 1	V <sub>DIOV1</sub>	-	V <sub>DIOV1</sub> - 0.002	V <sub>DIOV1</sub>	V <sub>DIOV1</sub> + 0.002	V	5
Discharge overcurrent detection voltage 2	V <sub>DIOV2</sub>	-	V <sub>DIOV2</sub> - 0.003	V <sub>DIOV2</sub>	V <sub>DIOV2</sub> + 0.003	V	2
Load short-circuiting detection voltage	V <sub>SHORT</sub>	-	V <sub>SHORT</sub> - 0.005	V <sub>SHORT</sub>	V <sub>SHORT</sub> + 0.005	V	2
Load short-circuiting detection voltage 2	V <sub>SHORT2</sub>	-	V <sub>DD</sub> - 1.4	V <sub>DD</sub> - 0.8	V <sub>DD</sub> - 0.3	V	2
Charge overcurrent detection voltage	V <sub>CIOV</sub>	-	V <sub>CIOV</sub> - 0.002	V <sub>CIOV</sub>	V <sub>CIOV</sub> + 0.002	V	2
Discharge overcurrent release voltage	V <sub>RIOV</sub>	V <sub>DD</sub> = 3.4 V	V <sub>DD</sub> × 0.77	V <sub>DD</sub> × 0.80	V <sub>DD</sub> × 0.83	V	5
<b>0 V Battery Charge Function</b>							
0 V battery charge starting charger voltage	V <sub>OCHA</sub>	0 V battery charge function "available"	0.5	1.1	1.7	V	4
0 V battery charge inhibition battery voltage	V <sub>OINH</sub>	0 V battery charge function "unavailable"	0.7	1.2	1.7	V	2
<b>Internal Resistance</b>							
Resistance between VDD pin and VM pin	R <sub>VMD</sub>	V <sub>DD</sub> = 1.8 V, V <sub>VM</sub> = 0 V	250	1250	3500	kΩ	3
Resistance between VM pin and VSS pin	R <sub>VMS</sub>	V <sub>DD</sub> = 3.4 V, V <sub>VM</sub> = 1.0 V	3.5	10	20	kΩ	3
<b>Input Voltage</b>							
Operation voltage between VDD pin and VSS pin	V <sub>DSOP1</sub>	-	1.5	-	6.0	V	-
Operation voltage between VDD pin and VM pin	V <sub>DSOP2</sub>	-	1.5	-	28	V	-
<b>Input Current</b>							
Current consumption during operation	I <sub>OP</sub>	V <sub>DD</sub> = 3.4 V, V <sub>VM</sub> = 0 V	-	2.0	5.0	μA	3
Current consumption during power-down	I <sub>PDN</sub>	V <sub>DD</sub> = V <sub>VM</sub> = 1.5 V	-	-	0.1	μA	3
Current consumption during overdischarge	I <sub>OPED</sub>	V <sub>DD</sub> = V <sub>VM</sub> = 1.5 V	-	-	1.0	μA	3
<b>Output Resistance</b>							
CO pin resistance "H"	R <sub>COH</sub>	-	2.5	10	30	kΩ	4
CO pin resistance "L"	R <sub>COL</sub>	-	2.5	10	30	kΩ	4
DO pin resistance "H"	R <sub>DOH</sub>	-	2.5	10	30	kΩ	4
DO pin resistance "L"	R <sub>DOL</sub>	-	0.5	2	6	kΩ	4
<b>Delay Time</b>							
Overcharge detection delay time	t <sub>CU</sub>	-	t <sub>CU</sub> × 0.6	t <sub>CU</sub>	t <sub>CU</sub> × 1.4	-	5
Overdischarge detection delay time	t <sub>DL</sub>	-	t <sub>DL</sub> × 0.6	t <sub>DL</sub>	t <sub>DL</sub> × 1.4	-	5
Discharge overcurrent detection delay time 1	t <sub>DIOV1</sub>	-	t <sub>DIOV1</sub> × 0.65	t <sub>DIOV1</sub>	t <sub>DIOV1</sub> × 1.35	-	5
Discharge overcurrent detection delay time 2	t <sub>DIOV2</sub>	-	t <sub>DIOV2</sub> × 0.6	t <sub>DIOV2</sub>	t <sub>DIOV2</sub> × 1.4	-	5
Load short-circuiting detection delay time	t <sub>SHORT</sub>	-	t <sub>SHORT</sub> × 0.6	t <sub>SHORT</sub>	t <sub>SHORT</sub> × 1.4	-	5
Charge overcurrent detection delay time	t <sub>CIOV</sub>	-	t <sub>CIOV</sub> × 0.6	t <sub>CIOV</sub>	t <sub>CIOV</sub> × 1.4	-	5

\*1. Since products are not screened at high and low temperature, the specification for this temperature range is guaranteed by design, not tested in production.



# BATTERY PROTECTION IC FOR 1-CELL PACK S-82F1B Series

Rev.3.1\_00

### 3. Ta = -40°C to +85°C\*1

**Table 10**

(Ta = -40°C to +85°C\*1 unless otherwise specified)

Item	Symbol	Condition	Min.	Typ.	Max.	Unit	Test Circuit
<b>Detection Voltage</b>							
Overcharge detection voltage	V <sub>CU</sub>	-	V <sub>CU</sub> - 0.045	V <sub>CU</sub>	V <sub>CU</sub> + 0.030	V	1
Overcharge release voltage	V <sub>CL</sub>	V <sub>CL</sub> ≠ V <sub>CU</sub>	V <sub>CL</sub> - 0.080	V <sub>CL</sub>	V <sub>CL</sub> + 0.060	V	1
		V <sub>CL</sub> = V <sub>CU</sub>	V <sub>CL</sub> - 0.050	V <sub>CL</sub>	V <sub>CL</sub> + 0.030	V	1
Overdischarge detection voltage	V <sub>DL</sub>	-	V <sub>DL</sub> - 0.080	V <sub>DL</sub>	V <sub>DL</sub> + 0.060	V	2
Overdischarge release voltage	V <sub>DU</sub>	V <sub>DL</sub> ≠ V <sub>DU</sub>	V <sub>DU</sub> - 0.105	V <sub>DU</sub>	V <sub>DU</sub> + 0.085	V	2
		V <sub>DL</sub> = V <sub>DU</sub>	V <sub>DU</sub> - 0.080	V <sub>DU</sub>	V <sub>DU</sub> + 0.060	V	2
Discharge overcurrent detection voltage 1	V <sub>DIOV1</sub>	-	V <sub>DIOV1</sub> - 0.002	V <sub>DIOV1</sub>	V <sub>DIOV1</sub> + 0.002	V	5
Discharge overcurrent detection voltage 2	V <sub>DIOV2</sub>	-	V <sub>DIOV2</sub> - 0.003	V <sub>DIOV2</sub>	V <sub>DIOV2</sub> + 0.003	V	2
Load short-circuiting detection voltage	V <sub>SHORT</sub>	-	V <sub>SHORT</sub> - 0.005	V <sub>SHORT</sub>	V <sub>SHORT</sub> + 0.005	V	2
Load short-circuiting detection voltage 2	V <sub>SHORT2</sub>	-	V <sub>DD</sub> - 1.4	V <sub>DD</sub> - 0.8	V <sub>DD</sub> - 0.3	V	2
Charge overcurrent detection voltage	V <sub>CIOV</sub>	-	V <sub>CIOV</sub> - 0.002	V <sub>CIOV</sub>	V <sub>CIOV</sub> + 0.002	V	2
Discharge overcurrent release voltage	V <sub>RIOV</sub>	V <sub>DD</sub> = 3.4 V	V <sub>DD</sub> × 0.77	V <sub>DD</sub> × 0.80	V <sub>DD</sub> × 0.83	V	5
<b>0 V Battery Charge Function</b>							
0 V battery charge starting charger voltage	V <sub>OCHA</sub>	0 V battery charge function "available"	0.5	1.1	1.7	V	4
0 V battery charge inhibition battery voltage	V <sub>OINH</sub>	0 V battery charge function "unavailable"	0.7	1.2	1.7	V	2
<b>Internal Resistance</b>							
Resistance between VDD pin and VM pin	R <sub>VMD</sub>	V <sub>DD</sub> = 1.8 V, V <sub>VM</sub> = 0 V	250	1250	3500	kΩ	3
Resistance between VM pin and VSS pin	R <sub>VMS</sub>	V <sub>DD</sub> = 3.4 V, V <sub>VM</sub> = 1.0 V	3.5	10	20	kΩ	3
<b>Input Voltage</b>							
Operation voltage between VDD pin and VSS pin	V <sub>DSOP1</sub>	-	1.5	-	6.0	V	-
Operation voltage between VDD pin and VM pin	V <sub>DSOP2</sub>	-	1.5	-	28	V	-
<b>Input Current</b>							
Current consumption during operation	I <sub>OPE</sub>	V <sub>DD</sub> = 3.4 V, V <sub>VM</sub> = 0 V	-	2.0	5.0	μA	3
Current consumption during power-down	I <sub>PDN</sub>	V <sub>DD</sub> = V <sub>VM</sub> = 1.5 V	-	-	0.1	μA	3
Current consumption during overdischarge	I <sub>OPED</sub>	V <sub>DD</sub> = V <sub>VM</sub> = 1.5 V	-	-	1.0	μA	3
<b>Output Resistance</b>							
CO pin resistance "H"	R <sub>COH</sub>	-	2.5	10	30	kΩ	4
CO pin resistance "L"	R <sub>COL</sub>	-	2.5	10	30	kΩ	4
DO pin resistance "H"	R <sub>DOH</sub>	-	2.5	10	30	kΩ	4
DO pin resistance "L"	R <sub>DOL</sub>	-	0.5	2	6	kΩ	4
<b>Delay Time</b>							
Overcharge detection delay time	t <sub>CU</sub>	-	t <sub>CU</sub> × 0.4	t <sub>CU</sub>	t <sub>CU</sub> × 1.6	-	5
Overdischarge detection delay time	t <sub>DL</sub>	-	t <sub>DL</sub> × 0.4	t <sub>DL</sub>	t <sub>DL</sub> × 1.6	-	5
Discharge overcurrent detection delay time 1	t <sub>DIOV1</sub>	-	t <sub>DIOV1</sub> × 0.4	t <sub>DIOV1</sub>	t <sub>DIOV1</sub> × 1.6	-	5
Discharge overcurrent detection delay time 2	t <sub>DIOV2</sub>	-	t <sub>DIOV2</sub> × 0.4	t <sub>DIOV2</sub>	t <sub>DIOV2</sub> × 1.6	-	5
Load short-circuiting detection delay time	t <sub>SHORT</sub>	-	t <sub>SHORT</sub> × 0.4	t <sub>SHORT</sub>	t <sub>SHORT</sub> × 1.6	-	5
Charge overcurrent detection delay time	t <sub>CIOV</sub>	-	t <sub>CIOV</sub> × 0.4	t <sub>CIOV</sub>	t <sub>CIOV</sub> × 1.6	-	5

\*1. Since products are not screened at high and low temperature, the specification for this temperature range is guaranteed by design, not tested in production.

## ■ Test Circuits

**Caution** Unless otherwise specified, the output voltage levels "H" and "L" at CO pin ( $V_{CO}$ ) and DO pin ( $V_{DO}$ ) are judged by the threshold voltage (1.0 V) of the N-channel FET. Judge the CO pin level with respect to  $V_{VM}$  and the DO pin level with respect to  $V_{SS}$ .

### 1. Overcharge detection voltage, overcharge release voltage (Test circuit 1)

Overcharge detection voltage ( $V_{CU}$ ) is defined as the voltage  $V_1$  at which  $V_{CO}$  goes from "H" to "L" when the voltage  $V_1$  is gradually increased after setting  $V_1 = 3.4$  V. Overcharge release voltage ( $V_{CL}$ ) is defined as the voltage  $V_1$  at which  $V_{CO}$  goes from "L" to "H" when the voltage  $V_1$  is then gradually decreased. Overcharge hysteresis voltage ( $V_{HC}$ ) is defined as the difference between  $V_{CU}$  and  $V_{CL}$ .

### 2. Overdischarge detection voltage, overdischarge release voltage (Test circuit 2)

Overdischarge detection voltage ( $V_{DL}$ ) is defined as the voltage  $V_1$  at which  $V_{DO}$  goes from "H" to "L" when the voltage  $V_1$  is gradually decreased after setting  $V_1 = 3.4$  V,  $V_2 = V_5 = 0$  V. Overdischarge release voltage ( $V_{DU}$ ) is defined as the voltage  $V_1$  at which  $V_{DO}$  goes from "L" to "H" when setting  $V_2 = 0.01$  V,  $V_5 = 0$  V and when the voltage  $V_1$  is then gradually increased. Overdischarge hysteresis voltage ( $V_{HD}$ ) is defined as the difference between  $V_{DU}$  and  $V_{DL}$ .

### 3. Discharge overcurrent detection voltage 1, discharge overcurrent release voltage (Test circuit 5)

Discharge overcurrent detection voltage 1 ( $V_{DIOV1}$ ) is defined as the voltage  $V_5$  whose delay time for changing  $V_{DO}$  from "H" to "L" is discharge overcurrent detection delay time 1 ( $t_{DIOV1}$ ) when the voltage  $V_5$  is increased after setting  $V_1 = 3.4$  V,  $V_2 = 1.4$  V,  $V_5 = 0$  V. Discharge overcurrent release voltage ( $V_{RIOV}$ ) is defined as the voltage  $V_2$  at which  $V_{DO}$  goes from "L" to "H" when setting  $V_2 = 3.4$  V,  $V_5 = 0$  V and when the voltage  $V_2$  is then gradually decreased.

When the voltage  $V_2$  falls below  $V_{RIOV}$ ,  $V_{DO}$  will go to "H" after 1.0 ms typ. and maintain "H" during load short-circuiting detection delay time ( $t_{SHORT}$ ).

### 4. Discharge overcurrent detection voltage 2 (Test circuit 2)

Discharge overcurrent detection voltage 2 ( $V_{DIOV2}$ ) is defined as the voltage  $V_5$  whose delay time for changing  $V_{DO}$  from "H" to "L" is discharge overcurrent detection delay time 2 ( $t_{DIOV2}$ ) when the voltage  $V_5$  is increased after setting  $V_1 = 3.4$  V,  $V_2 = 1.4$  V,  $V_5 = 0$  V.

### 5. Load short-circuiting detection voltage (Test circuit 2)

Load short-circuiting detection voltage ( $V_{SHORT}$ ) is defined as the voltage  $V_5$  whose delay time for changing  $V_{DO}$  from "H" to "L" is  $t_{SHORT}$  when the voltage  $V_5$  is increased after setting  $V_1 = 3.4$  V,  $V_2 = 1.4$  V,  $V_5 = 0$  V.

### 6. Load short-circuiting detection voltage 2 (Test circuit 2)

Load short-circuiting detection voltage 2 ( $V_{SHORT2}$ ) is defined as the voltage  $V_2$  whose delay time for changing  $V_{DO}$  from "H" to "L" is  $t_{SHORT}$  when the voltage  $V_2$  is increased after setting  $V_1 = 3.4$  V,  $V_2 = V_5 = 0$  V.

**7. Charge overcurrent detection voltage**  
**(Test circuit 2)**

Charge overcurrent detection voltage ( $V_{CIOV}$ ) is defined as the voltage  $V5$  whose delay time for changing  $V_{CO}$  from "H" to "L" is charge overcurrent detection delay time ( $t_{CIOV}$ ) when the voltage  $V5$  is decreased after setting  $V1 = 3.4\text{ V}$ ,  $V2 = V5 = 0\text{ V}$ .

**8. Current consumption during operation**  
**(Test circuit 3)**

The current consumption during operation ( $I_{OPE}$ ) is the current that flows through the VDD pin ( $I_{DD}$ ) after setting  $V1 = 3.4\text{ V}$ ,  $V2 = V5 = 0\text{ V}$ .

**9. Current consumption during power-down, current consumption during overdischarge**  
**(Test circuit 3)**

**9.1 With power-down function**

The current consumption during power-down ( $I_{PDN}$ ) is  $I_{DD}$  under the set conditions of  $V1 = V2 = 1.5\text{ V}$ ,  $V5 = 0\text{ V}$ .

**9.2 Without power-down function**

The current consumption during overdischarge ( $I_{OPED}$ ) is  $I_{DD}$  under the set conditions of  $V1 = V2 = 1.5\text{ V}$ ,  $V5 = 0\text{ V}$ .

**10. Resistance between VDD pin and VM pin**  
**(Test circuit 3)**

$R_{VMD}$  is the resistance between VDD pin and VM pin under the set conditions of  $V1 = 1.8\text{ V}$ ,  $V2 = V5 = 0\text{ V}$ .

**11. Resistance between VM pin and VSS pin**  
**(Test circuit 3)**

$R_{VMS}$  is the resistance between VM pin and VSS pin when the voltage  $V5$  is decreased to  $0\text{ V}$  after setting  $V1 = 3.4\text{ V}$ ,  $V2 = V5 = 1.0\text{ V}$ .

**12. CO pin resistance "H"**  
**(Test circuit 4)**

The CO pin resistance "H" ( $R_{COH}$ ) is the resistance between VDD pin and CO pin under the set conditions of  $V1 = 3.4\text{ V}$ ,  $V2 = V5 = 0\text{ V}$ ,  $V3 = 3.0\text{ V}$ .

**13. CO pin resistance "L"**  
**(Test circuit 4)**

The CO pin resistance "L" ( $R_{COL}$ ) is the resistance between VM pin and CO pin under the set conditions of  $V1 = 4.7\text{ V}$ ,  $V2 = V5 = 0\text{ V}$ ,  $V3 = 0.4\text{ V}$ .

**14. DO pin resistance "H"**  
**(Test circuit 4)**

The DO pin resistance "H" ( $R_{DOH}$ ) is the resistance between VDD pin and DO pin under the set conditions of  $V1 = 3.4\text{ V}$ ,  $V2 = V5 = 0\text{ V}$ ,  $V4 = 3.0\text{ V}$ .

**15. DO pin resistance "L"**  
**(Test circuit 4)**

The DO pin resistance "L" ( $R_{DOL}$ ) is the resistance between VSS pin and DO pin under the set conditions of  $V1 = 1.8\text{ V}$ ,  $V2 = V5 = 0\text{ V}$ ,  $V4 = 0.4\text{ V}$ .

**16. Overcharge detection delay time**  
**(Test circuit 5)**

Increase the voltage V1 after setting V1 = 3.4 V, V2 = V5 = 0 V. The overcharge detection delay time ( $t_{CU}$ ) is the time period from when the voltage V1 exceeds  $V_{CU}$  until  $V_{CO}$  goes to "L".

**17. Overdischarge detection delay time**  
**(Test circuit 5)**

Decrease the voltage V1 after setting V1 = 3.4 V, V2 = V5 = 0 V. The overdischarge detection delay time ( $t_{DL}$ ) is the time period from when the voltage V1 falls below  $V_{DL}$  until  $V_{DO}$  goes to "L".

**18. Discharge overcurrent detection delay time 1**  
**(Test circuit 5)**

Increase the voltage V5 after setting V1 = 3.4 V, V2 = 1.4 V, V5 = 0 V. The discharge overcurrent detection delay time 1 ( $t_{DIOV1}$ ) is the time period from when the voltage V5 exceeds  $V_{DIOV1}$  until  $V_{DO}$  goes to "L".

**19. Discharge overcurrent detection delay time 2**  
**(Test circuit 5)**

Increase the voltage V5 after setting V1 = 3.4 V, V2 = 1.4 V, V5 = 0 V. The discharge overcurrent detection delay time 2 ( $t_{DIOV2}$ ) is the time period from when the voltage V5 exceeds  $V_{DIOV2}$  until  $V_{DO}$  goes to "L".

**20. Load short-circuiting detection delay time**  
**(Test circuit 5)**

Increase the voltage V5 after setting V1 = 3.4 V, V2 = 1.4 V, V5 = 0 V. The load short-circuiting detection delay time ( $t_{SHORT}$ ) is the time period from when the voltage V5 exceeds  $V_{SHORT}$  until  $V_{DO}$  goes to "L".

**21. Charge overcurrent detection delay time**  
**(Test circuit 5)**

Decrease the voltage V5 after setting V1 = 3.4 V, V2 = V5 = 0 V. The charge overcurrent detection delay time ( $t_{CIOV}$ ) is the time period from when the voltage V5 falls below  $V_{CIOV}$  until  $V_{CO}$  goes to "L".

**22. 0 V battery charge starting charger voltage (0 V battery charge function "available")**  
**(Test circuit 4)**

The 0 V battery charge starting charger voltage ( $V_{0CHA}$ ) is defined as the absolute value of voltage V2 at which the current flowing through the CO pin ( $I_{CO}$ ) exceeds 1.0  $\mu$ A when the voltage V2 is gradually decreased after setting V1 = V5 = 0 V, V2 = V3 = -0.5 V.

**23. 0 V battery charge inhibition battery voltage (0 V battery charge function "unavailable")**  
**(Test circuit 2)**

The 0 V battery charge inhibition battery voltage ( $V_{0INH}$ ) is defined as the voltage V1 at which  $V_{CO}$  goes to "L" ( $V_{CO} = V_{VM}$ ) when the voltage V1 is gradually decreased after setting V1 = 1.8 V, V2 = -2.0 V, V5 = 0 V.

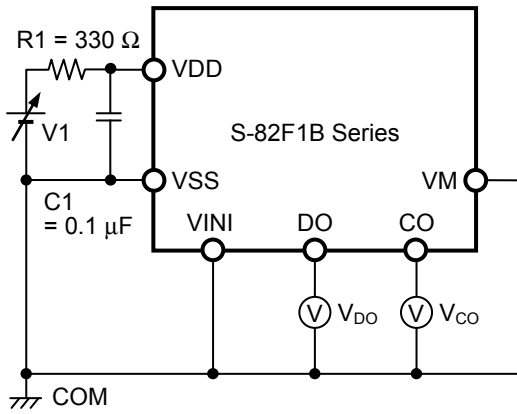

**Figure 3 Test Circuit 1**

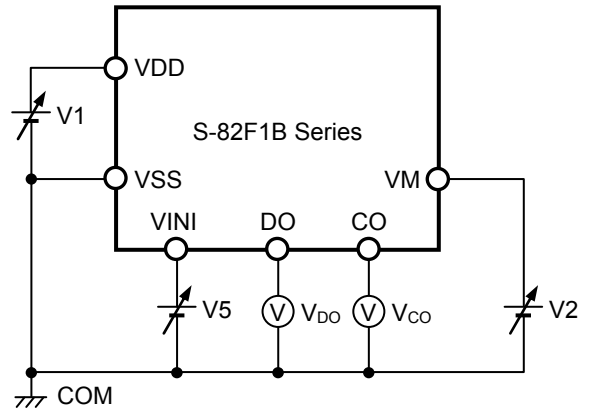

**Figure 4 Test Circuit 2**

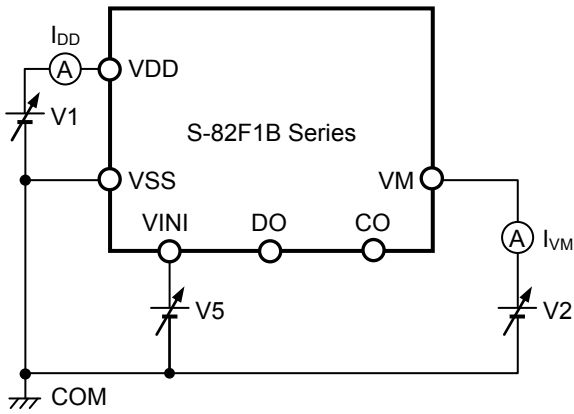

**Figure 5 Test Circuit 3**

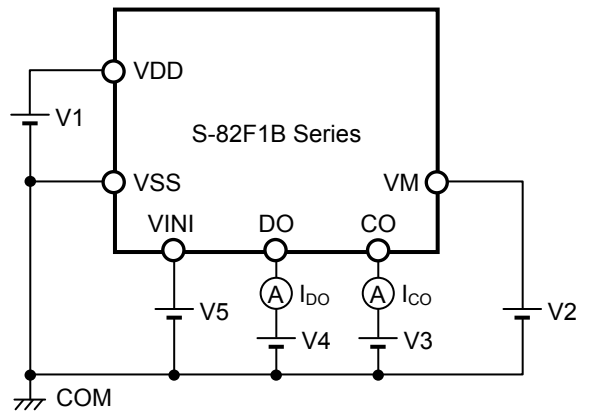

**Figure 6 Test Circuit 4**

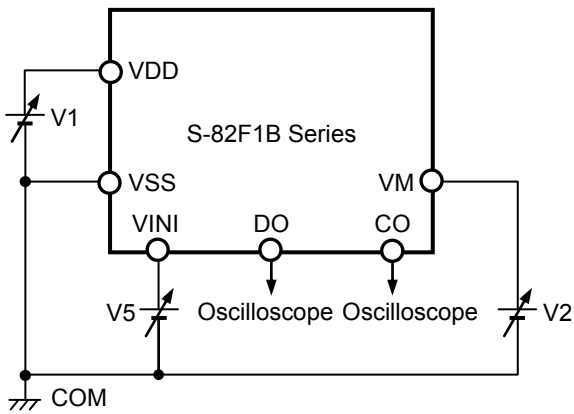

**Figure 7 Test Circuit 5**

## ■ Operation

**Remark** Refer to "■ Battery Protection IC Connection Example".

### 1. Normal status

The S-82F1B Series monitors the voltage of the battery connected between VDD pin and VSS pin, the voltage between VINI pin and VSS pin to control charging and discharging. When the battery voltage is in the range from overdischarge detection voltage ( $V_{DL}$ ) to overcharge detection voltage ( $V_{CU}$ ), and the VINI pin voltage is in the range from charge overcurrent detection voltage ( $V_{CIOV}$ ) to discharge overcurrent detection voltage 1 ( $V_{DIOV1}$ ), the S-82F1B Series turns both the charge and discharge control FETs on. This condition is called the normal status, and in this condition charging and discharging can be carried out freely.

The resistance between VDD pin and VM pin ( $R_{VMD}$ ), and the resistance between VM pin and VSS pin ( $R_{VMS}$ ) are not connected in the normal status.

**Caution** After the battery is connected, discharging may not be carried out. In this case, the S-82F1B Series returns to the normal status by connecting a charger.

### 2. Overcharge status

#### 2.1 $V_{CL} \neq V_{CU}$ (Product in which overcharge release voltage differs from overcharge detection voltage)

When the battery voltage becomes higher than  $V_{CU}$  during charging in the normal status and the condition continues for the overcharge detection delay time ( $t_{CU}$ ) or longer, the S-82F1B Series turns the charge control FET off to stop charging. This condition is called the overcharge status.

The overcharge status is released in the following two cases.

- (1) In the case that the VM pin voltage is lower than 0.35 V typ., the S-82F1B Series releases the overcharge status when the battery voltage falls below overcharge release voltage ( $V_{CL}$ ).
- (2) In the case that the VM pin voltage is equal to or higher than 0.35 V typ., the S-82F1B Series releases the overcharge status when the battery voltage falls below  $V_{CU}$ .

When the discharge is started by connecting a load after the overcharge detection, the VM pin voltage rises by the  $V_f$  voltage of the parasitic diode than the VSS pin voltage, because the discharge current flows through the parasitic diode in the charge control FET. If this VM pin voltage is equal to or higher than 0.35 V typ., the S-82F1B Series releases the overcharge status when the battery voltage is equal to or lower than  $V_{CU}$ .

**Caution** If the battery is charged to a voltage higher than  $V_{CU}$  and the battery voltage does not fall below  $V_{CU}$  even when a heavy load is connected, discharge overcurrent detection and load short-circuiting detection do not function until the battery voltage falls below  $V_{CU}$ . Since an actual battery has an internal impedance of tens of  $m\Omega$ , the battery voltage drops immediately after a heavy load that causes overcurrent is connected, and discharge overcurrent detection and load short-circuiting detection function.

#### 2.2 $V_{CL} = V_{CU}$ (Product in which overcharge release voltage is the same as overcharge detection voltage)

When the battery voltage becomes higher than  $V_{CU}$  during charging in the normal status and the condition continues for the overcharge detection delay time ( $t_{CU}$ ) or longer, the S-82F1B Series turns the charge control FET off to stop charging. This condition is called the overcharge status.

In the case that the VM pin voltage is equal to or higher than 0.35 V typ. and the battery voltage falls below  $V_{CU}$ , the S-82F1B Series releases the overcharge status.

When the discharge is started by connecting a load after the overcharge detection, the VM pin voltage rises by the  $V_f$  voltage of the parasitic diode than the VSS pin voltage, because the discharge current flows through the parasitic diode in the charge control FET. If this VM pin voltage is equal to or higher than 0.35 V typ., the S-82F1B Series releases the overcharge status when the battery voltage is equal to or lower than  $V_{CU}$ .

**Caution 1.** If the battery is charged to a voltage higher than  $V_{CU}$  and the battery voltage does not fall below  $V_{CU}$  even when a heavy load is connected, discharge overcurrent detection and load short-circuiting detection do not function until the battery voltage falls below  $V_{CU}$ . Since an actual battery has an internal impedance of tens of  $m\Omega$ , the battery voltage drops immediately after a heavy load that causes overcurrent is connected, and discharge overcurrent detection and load short-circuiting detection function.

2. When a charger is connected after overcharge detection, the overcharge status is not released even if the battery voltage is below  $V_{CL}$ . The overcharge status is released when the discharge current flows and the VM pin voltage goes over 0.35 V typ. by removing the charger.

### 3. Overdischarge status

When the battery voltage falls below  $V_{DL}$  during discharging in the normal status and the condition continues for the overdischarge detection delay time ( $t_{DL}$ ) or longer, the S-82F1B Series turns the discharge control FET off to stop discharging. This condition is called the overdischarge status.

Under the overdischarge status, VDD pin and VM pin are shorted by  $R_{VMD}$  in the S-82F1B Series. The VM pin voltage is pulled up by  $R_{VMD}$ .

When connecting a charger in the overdischarge status, the battery voltage reaches  $V_{DL}$  or higher and the S-82F1B Series releases the overdischarge status if the VM pin voltage falls below 0 V typ.

The battery voltage reaches the overdischarge release voltage ( $V_{DU}$ ) or higher and the S-82F1B Series releases the overdischarge status if the VM pin voltage does not fall below 0 V typ.

$R_{VMS}$  is not connected in the overdischarge status.

#### 3.1 With power-down function

Under the overdischarge status, when voltage difference between VDD pin and VM pin is 0.8 V typ. or lower, the power-down function works and the current consumption is reduced to the current consumption during power-down ( $I_{PDN}$ ). By connecting a battery charger, the power-down function is released when the VM pin voltage is 0.7 V typ. or lower.

- When a battery is not connected to a charger and the VM pin voltage  $\geq 0.7$  V typ., the S-82F1B Series maintains the overdischarge status even when the battery voltage reaches  $V_{DU}$  or higher.
- When a battery is connected to a charger and 0.7 V typ. > the VM pin voltage > 0 V typ., the battery voltage reaches  $V_{DU}$  or higher and the S-82F1B Series releases the overdischarge status.
- When a battery is connected to a charger and 0 V typ.  $\geq$  the VM pin voltage, the battery voltage reaches  $V_{DL}$  or higher and the S-82F1B Series releases the overdischarge status.

#### 3.2 Without power-down function

The power-down function does not work even when voltage difference between VDD pin and VM pin is 0.8 V typ. or lower.

- When a battery is not connected to a charger and the VM pin voltage  $\geq 0.7$  V typ., the battery voltage reaches  $V_{DU}$  or higher and the S-82F1B Series releases the overdischarge status.
- When a battery is connected to a charger and 0.7 V typ. > the VM pin voltage > 0 V typ., the battery voltage reaches  $V_{DU}$  or higher and the S-82F1B Series releases the overdischarge status.
- When a battery is connected to a charger and 0 V typ.  $\geq$  the VM pin voltage, the battery voltage reaches  $V_{DL}$  or higher and the S-82F1B Series releases the overdischarge status.

### 4. Discharge overcurrent status (discharge overcurrent 1, discharge overcurrent 2, load short-circuiting, load short-circuiting 2)

#### 4.1 Discharge overcurrent 1, discharge overcurrent 2, load short-circuiting

When a battery in the normal status is in the status where the VINI pin voltage is equal to or higher than  $V_{DIOV1}$  because the discharge current is equal to or higher than the specified value and the status lasts for the discharge overcurrent detection delay time 1 ( $t_{DIOV1}$ ) or longer, the discharge control FET is turned off and discharging is stopped. This status is called the discharge overcurrent status.

Under the discharge overcurrent status, VM pin and VSS pin are shorted by  $R_{VMS}$  in the S-82F1B Series. However, the VM pin voltage is the VDD pin voltage due to the load as long as the load is connected. When the load is disconnected, the VM pin returns to the VSS pin voltage. When the VM pin voltage returns to  $V_{RIOV}$  or lower, the S-82F1B Series releases the discharge overcurrent status.

$R_{VMD}$  is not connected in the discharge overcurrent status.

#### 4.2 Load short-circuiting 2

When a battery in the normal status is in the status where a load causing discharge overcurrent is connected, and the VM pin voltage is equal to or higher than  $V_{SHORT2}$  and the status lasts for the load short-circuiting detection delay time ( $t_{SHORT}$ ) or longer, the discharge control FET is turned off and discharging is stopped. The S-82F1B Series then becomes discharge overcurrent status.

The S-82F1B Series releases the discharge overcurrent status in the same way as in "4.1 Discharge overcurrent 1, discharge overcurrent 2, load short-circuiting".

## 5. Charge overcurrent status

When a battery in the normal status is in the status where the VINI pin voltage is equal to or lower than  $V_{C1OV}$  because the charge current is equal to or higher than the specified value and the status lasts for the charge overcurrent detection delay time ( $t_{C1OV}$ ) or longer, the charge control FET is turned off and charging is stopped. This status is called the charge overcurrent status.

The S-82F1B Series releases the charge overcurrent status when the discharge current flows and the VM pin voltage is 0.35 V typ. or higher by removing the charger.

The charge overcurrent detection does not function in the overdischarge status.

## 6. 0 V battery charge function "available"

This function is used to recharge a connected battery whose voltage is 0 V due to self-discharge. When the 0 V battery charge starting charger voltage ( $V_{0CHA}$ ) or a higher voltage is applied between the EB+ and EB- pins by connecting a charger, the charge control FET gate is fixed to the VDD pin voltage.

When the voltage between the gate and source of the charge control FET becomes equal to or higher than the threshold voltage due to the charger voltage, the charge control FET is turned on to start charging. At this time, the discharge control FET is off and the charging current flows through the internal parasitic diode in the discharge control FET. When the battery voltage becomes equal to or higher than  $V_{DL}$ , the S-82F1B Series returns to the normal status.

**Caution 1. Some battery providers do not recommend charging for a completely self-discharged lithium-ion rechargeable battery. Please ask the battery provider to determine whether to enable or inhibit the 0 V battery charge function.**

**2. The 0 V battery charge function has higher priority than the charge overcurrent detection function. Consequently, a product in which use of the 0 V battery charge function is enabled charges a battery forcibly and the charge overcurrent cannot be detected when the battery voltage is lower than  $V_{DL}$ .**

## 7. 0 V battery charge function "unavailable"

This function inhibits recharging when a battery that is internally short-circuited (0 V battery) is connected. When the battery voltage is the 0 V battery charge inhibition battery voltage ( $V_{0INH}$ ) or lower, the charge control FET gate is fixed to the EB- pin voltage to inhibit charging. When the battery voltage is  $V_{0INH}$  or higher, charging can be performed.

**Caution Some battery providers do not recommend charging for a completely self-discharged lithium-ion rechargeable battery. Please ask the battery provider to determine whether to enable or inhibit the 0 V battery charge function.**



**8. Delay circuit**

The detection delay times are determined by dividing a clock of approximately 4 kHz by the counter.

**Remark**  $t_{DIOV1}$ ,  $t_{DIOV2}$  and  $t_{SHORT}$  start when  $V_{DIOV1}$  is detected. When  $V_{DIOV2}$  or  $V_{SHORT}$  is detected over  $t_{DIOV2}$  or  $t_{SHORT}$  after the detection of  $V_{DIOV1}$ , the S-82F1B Series turns the discharge control FET off within  $t_{DIOV2}$  or  $t_{SHORT}$  of each detection.

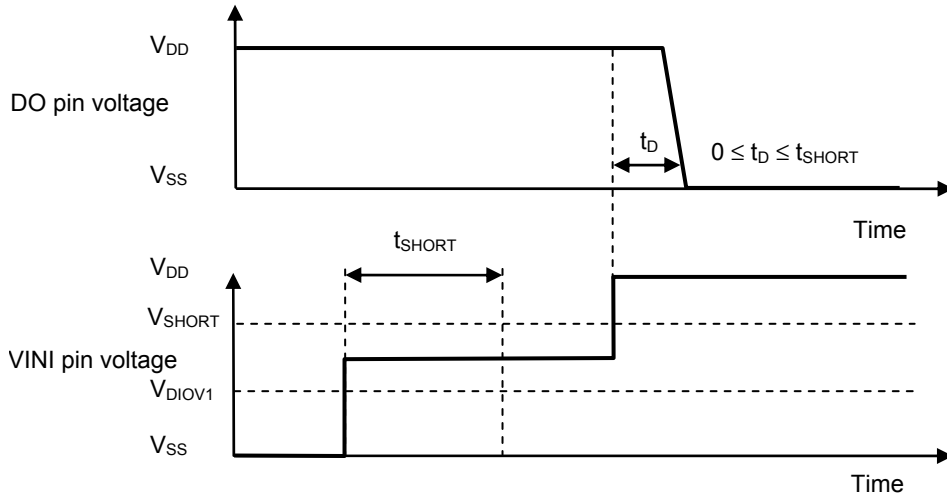

**Figure 8**

■ **Timing Charts**

**1. Overcharge detection, overdischarge detection**

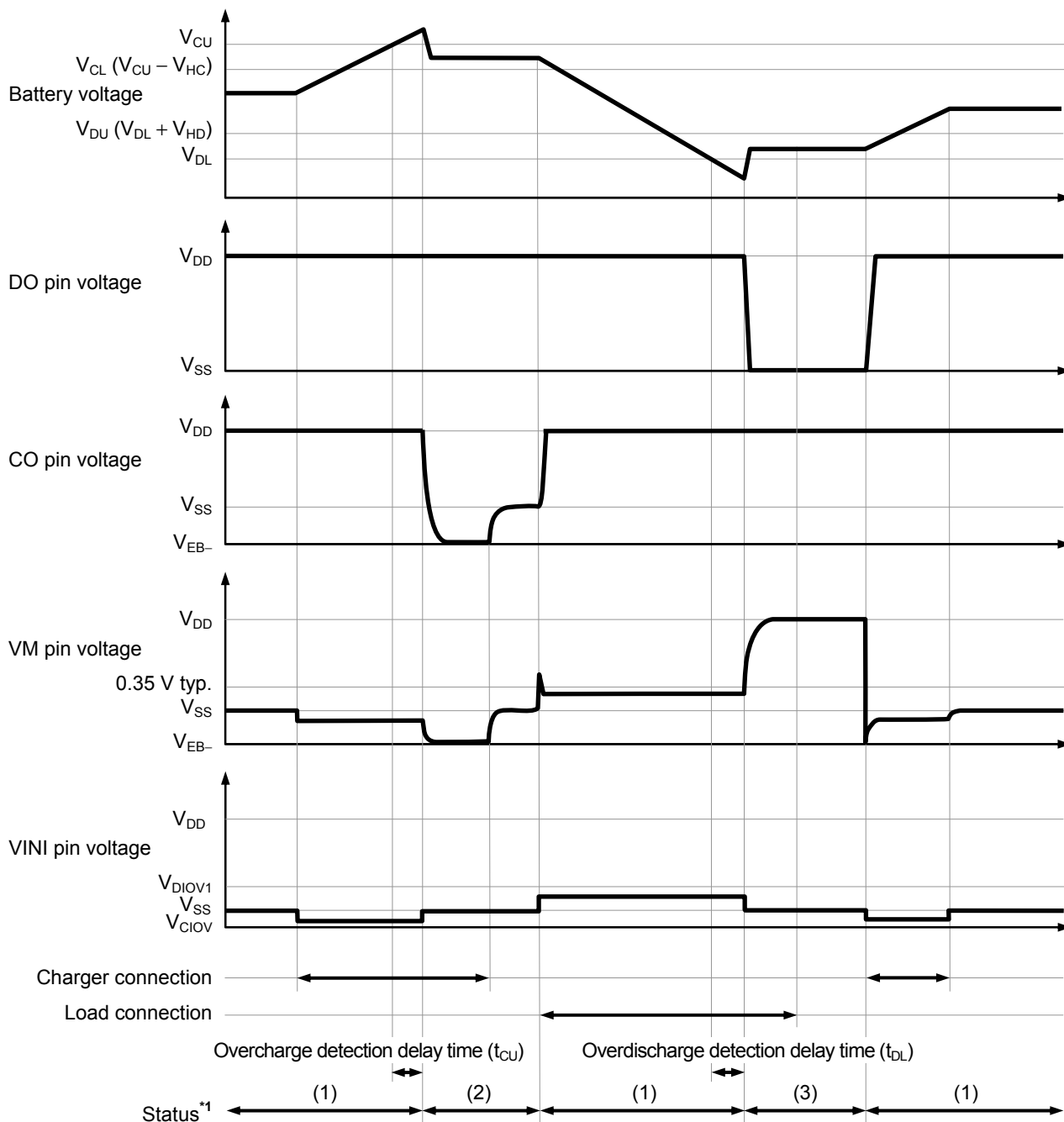

- \*1. (1): Normal status  
 (2): Overcharge status  
 (3): Overdischarge status

**Remark** The charger is assumed to charge with a constant current.

**Figure 9**

2. Discharge overcurrent detection

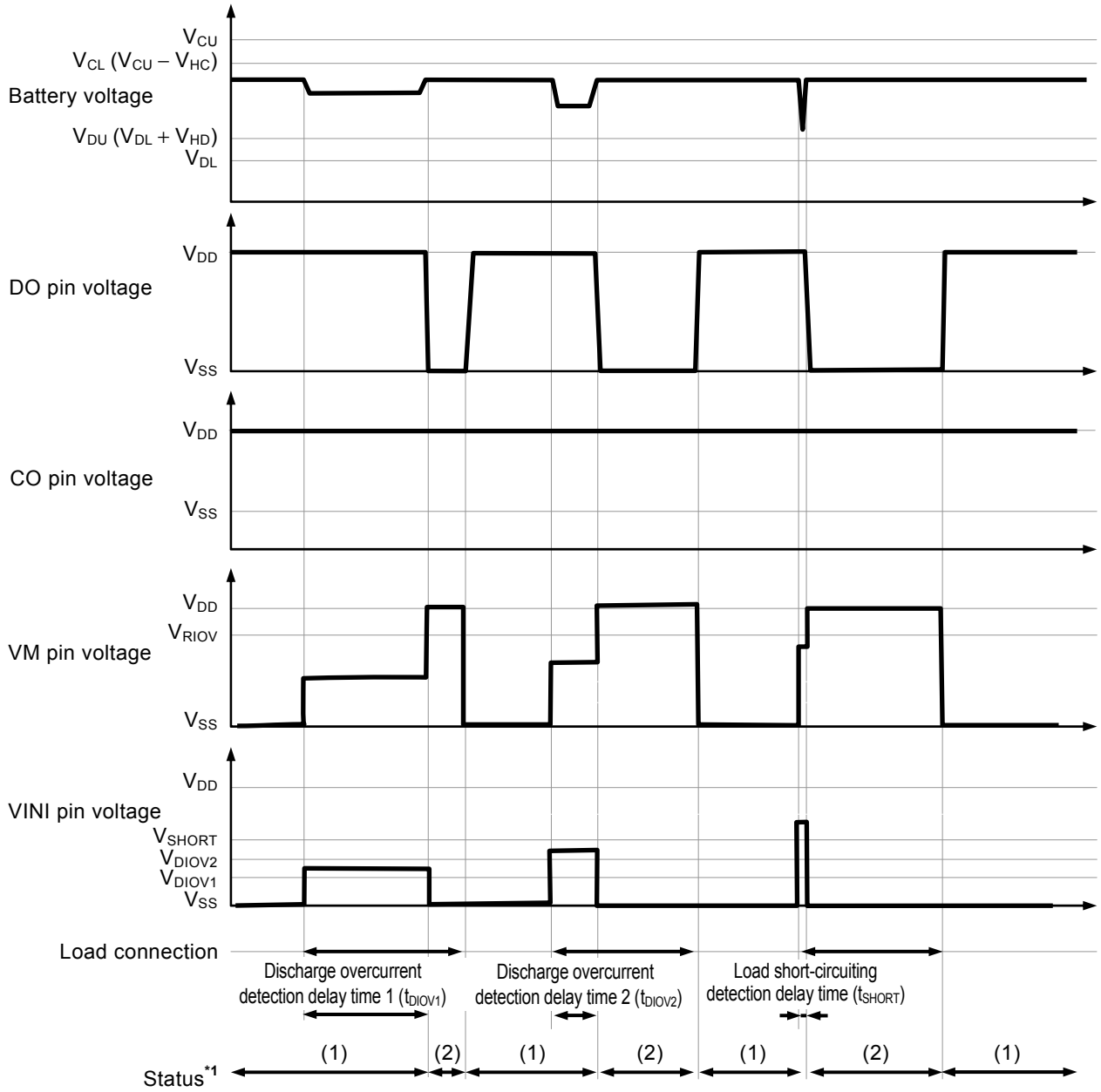

\*1. (1): Normal status  
(2): Discharge overcurrent status

**Remark** The charger is assumed to charge with a constant current.

Figure 10

**3. Charge overcurrent detection**

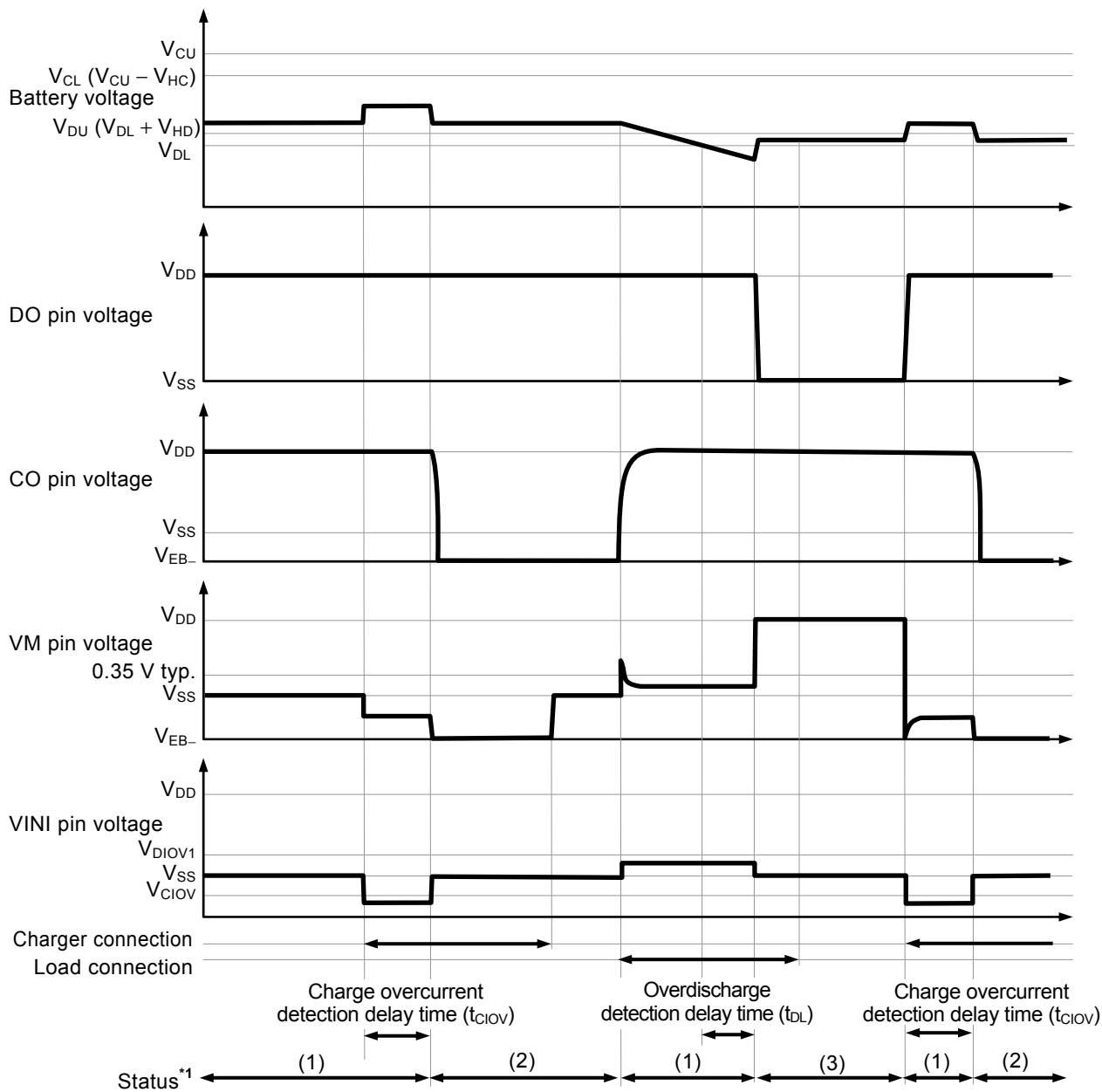

- \*1. (1): Normal status  
 (2): Charge overcurrent status  
 (3): Overdischarge status

**Remark** The charger is assumed to charge with a constant current.

**Figure 11**

### ■ Battery Protection IC Connection Example

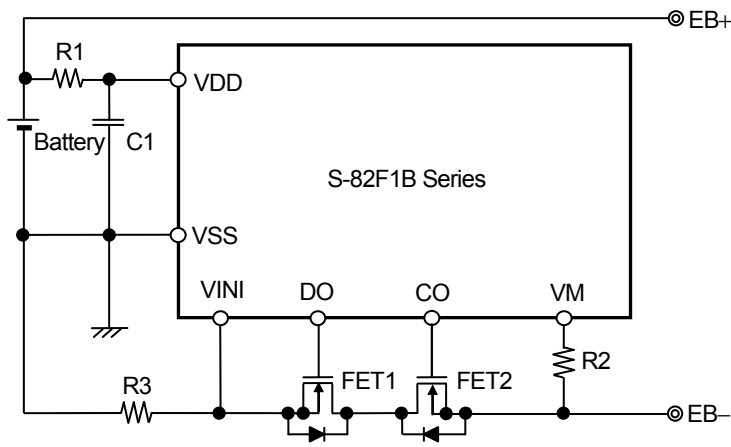

Figure 12

Table 11 Constants for External Components

Symbol	Part	Purpose	Min.	Typ.	Max.	Remark
FET1	N-channel MOS FET	Discharge control	-	-	-	Threshold voltage $\leq$ Overdischarge detection voltage <sup>*1</sup>
FET2	N-channel MOS FET	Charge control	-	-	-	Threshold voltage $\leq$ Overdischarge detection voltage <sup>*1</sup>
R1	Resistor	ESD protection, For power fluctuation	270 $\Omega$	330 $\Omega$	1.2 k $\Omega$ <sup>*2</sup>	-
C1	Capacitor	For power fluctuation	0.068 $\mu$ F	0.1 $\mu$ F	2.2 $\mu$ F	-
R2	Resistor	ESD protection, Protection for reverse connection of a charger	300 $\Omega$	470 $\Omega$	1.5 k $\Omega$	-
R3	Resistor	Overcurrent detection	-	3 m $\Omega$	-	-

<sup>\*1</sup>. If a FET with a threshold voltage equal to or higher than the overdischarge detection voltage is used, discharging may be stopped before overdischarge is detected.

<sup>\*2</sup>. Accuracy of overcharge detection voltage is guaranteed by R1 = 330  $\Omega$ . Connecting resistors with other values will worsen the accuracy.

**Caution 1.** The above constants may be changed without notice.

**2.** It has not been confirmed whether the operation is normal or not in circuits other than the above example of connection. In addition, the example of connection shown above and the constant do not guarantee proper operation. Perform thorough evaluation using the actual application to set the constant.

■ **Precautions**

- The application conditions for the input voltage, output voltage, and load current should not exceed the power dissipation.
- Do not apply an electrostatic discharge to this IC that exceeds the performance ratings of the built-in electrostatic protection circuit.
- ABLIC Inc. claims no responsibility for any and all disputes arising out of or in connection with any infringement by products including this IC of patents owned by a third party.

■ Characteristics (Typical Data)

1. Current consumption

1.1  $I_{OPE}$  vs.  $T_a$

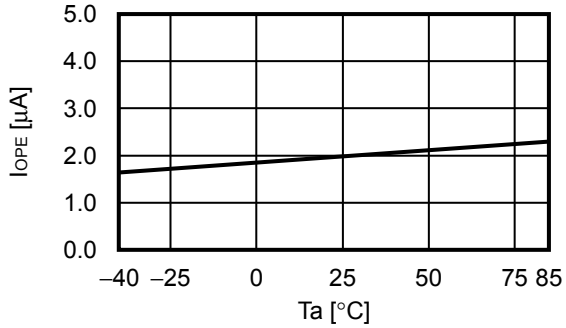

1.2  $I_{PDN}$  vs.  $T_a$

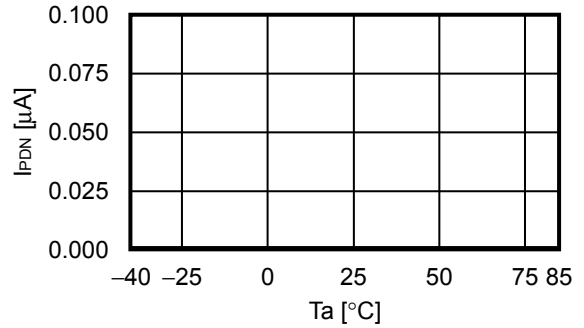

1.3  $I_{OPED}$  vs.  $T_a$

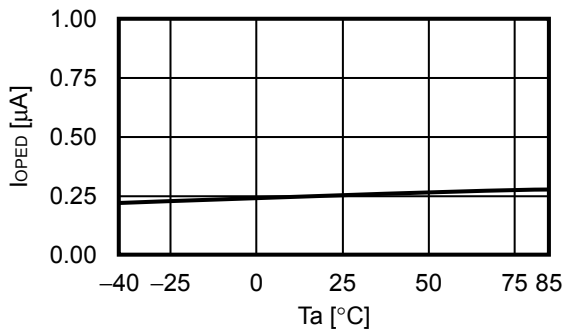

1.4  $I_{OPE}$  vs.  $V_{DD}$

1.4.1 With power-down function

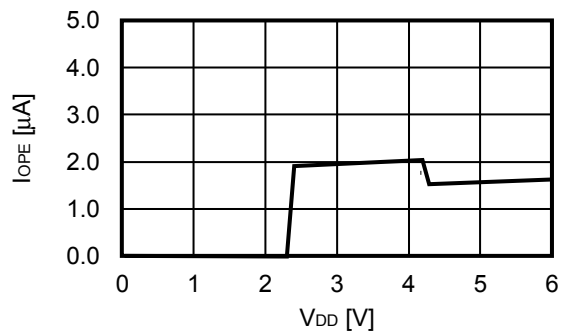

1.4.2 Without power-down function

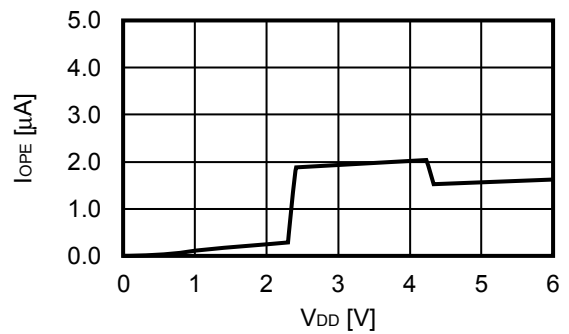

**2. Detection voltage**

**2.1  $V_{CU}$  vs.  $T_a$**

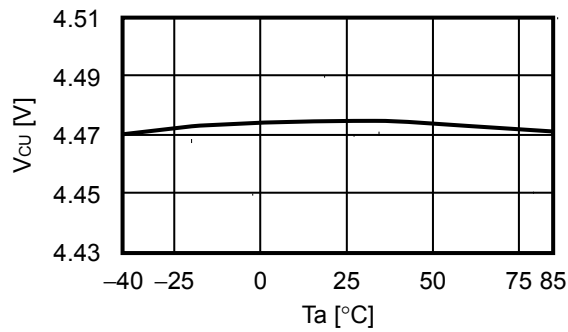

**2.2  $V_{CL}$  vs.  $T_a$**

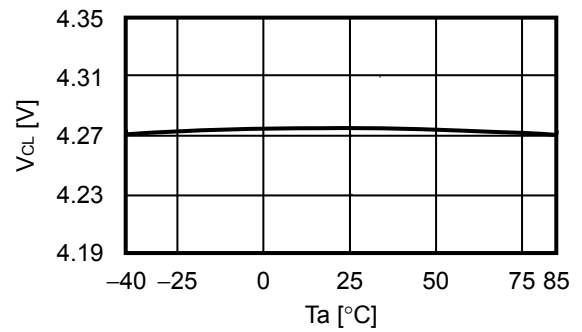

**2.3  $V_{DL}$  vs.  $T_a$**

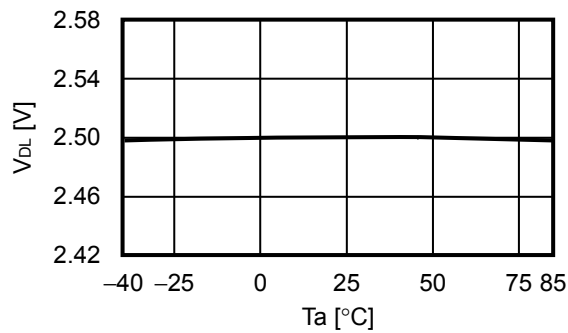

**2.4  $V_{DU}$  vs.  $T_a$**

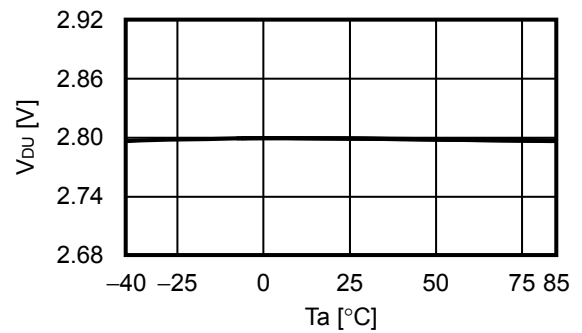

**2.5  $V_{DIOV1}$  vs.  $V_{DD}$**

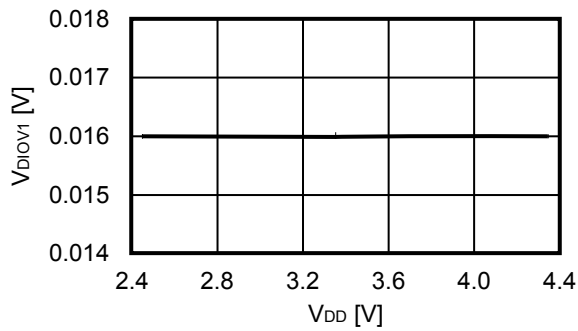

**2.6  $V_{DIOV1}$  vs.  $T_a$**

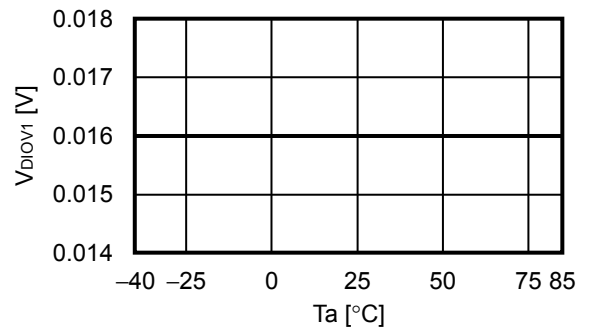

**2.7  $V_{DIOV2}$  vs.  $V_{DD}$**

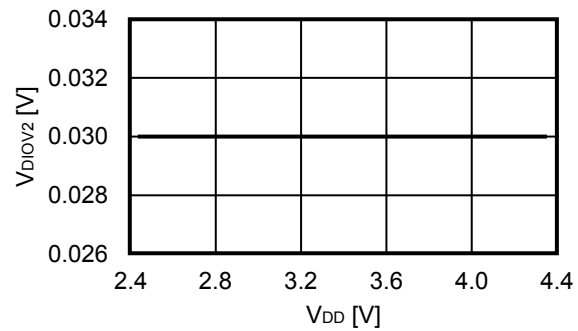

**2.8  $V_{DIOV2}$  vs.  $T_a$**

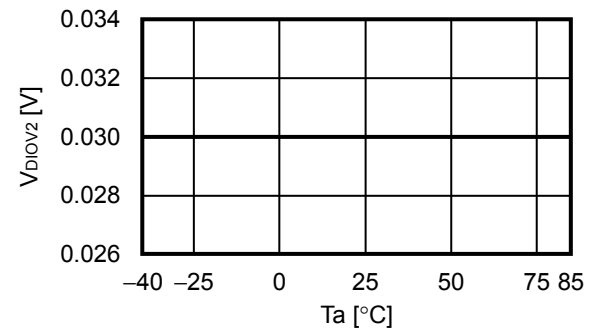



2. 9  $V_{SHORT}$  vs.  $V_{DD}$

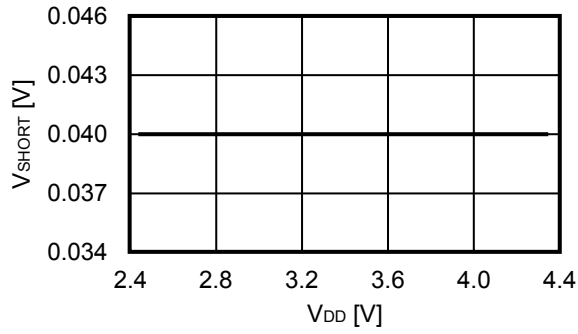

2. 10  $V_{SHORT}$  vs.  $T_a$

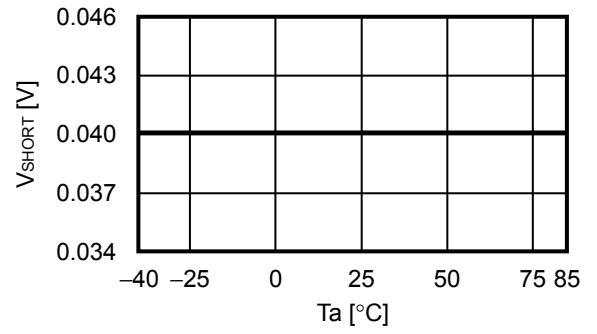

2. 11  $V_{CLOV}$  vs.  $V_{DD}$

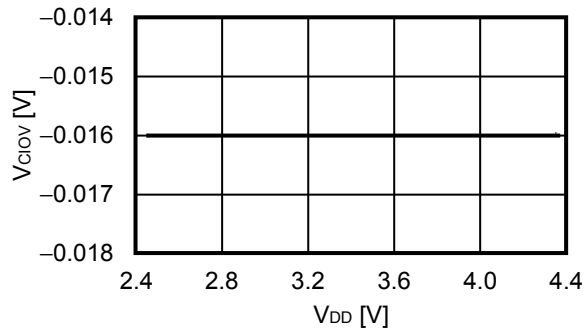

2. 12  $V_{CLOV}$  vs.  $T_a$

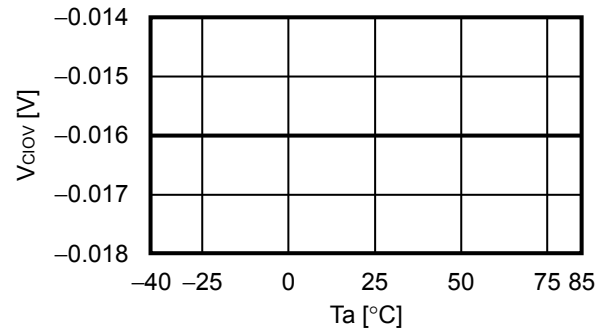

**3. Delay time**

**3.1  $t_{CU}$  vs.  $T_a$**

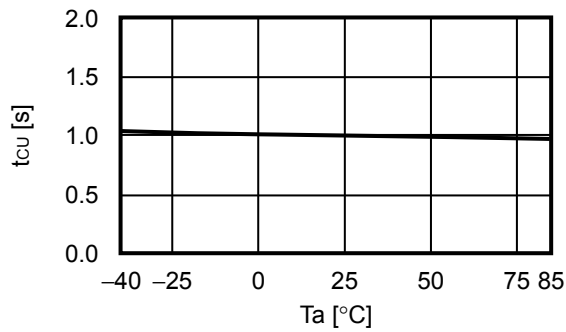

**3.2  $t_{DL}$  vs.  $T_a$**

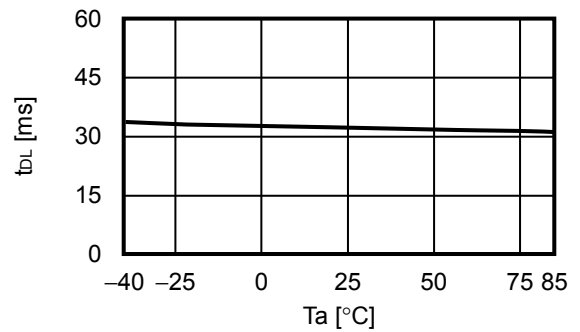

**3.3  $t_{DIOV1}$  vs.  $V_{DD}$**

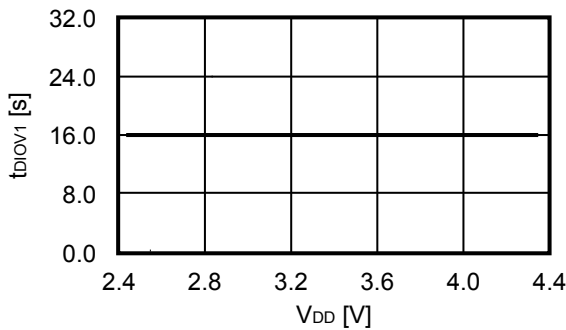

**3.4  $t_{DIOV1}$  vs.  $T_a$**

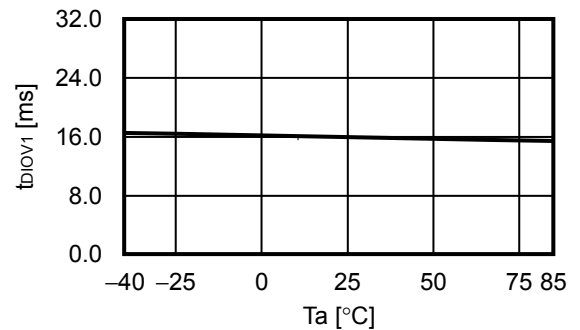

**3.5  $t_{DIOV2}$  vs.  $V_{DD}$**

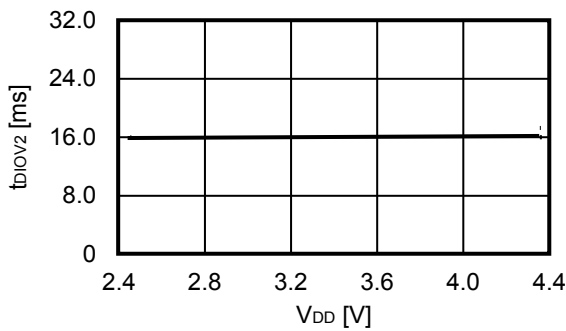

**3.6  $t_{DIOV2}$  vs.  $T_a$**

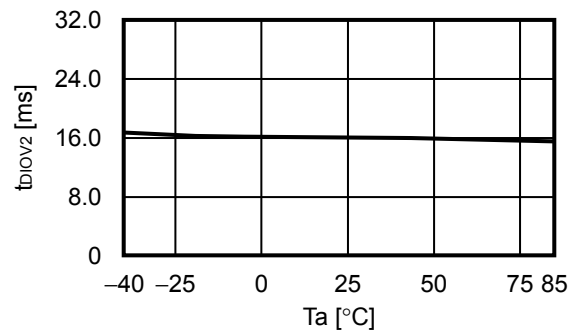

**3.7  $t_{SHORT}$  vs.  $V_{DD}$**

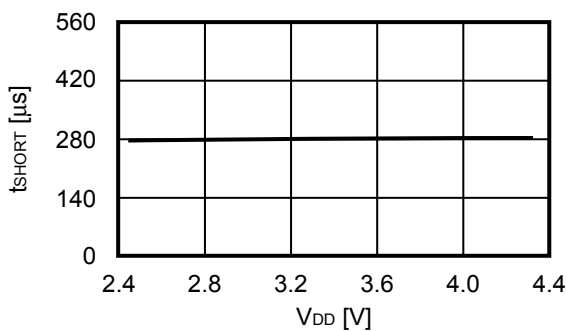

**3.8  $t_{SHORT}$  vs.  $T_a$**

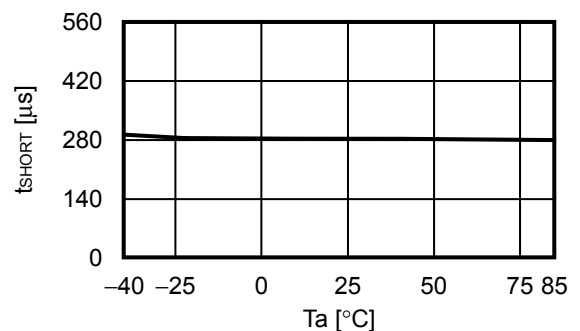

3.9  $t_{CI0V}$  vs.  $V_{DD}$

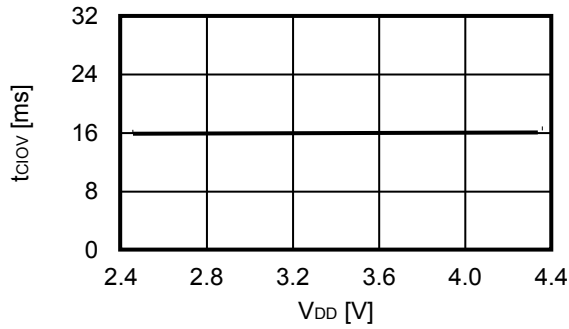

3.10  $t_{CI0V}$  vs.  $T_a$

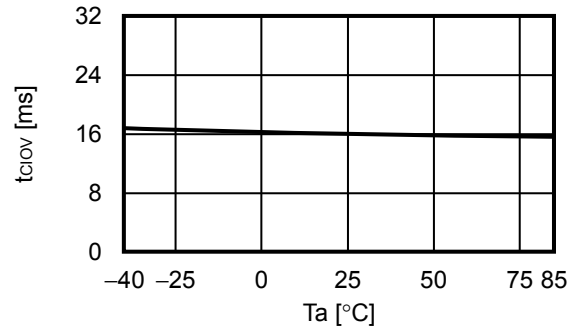

#### 4. Output resistance

4.1  $R_{COH}$  vs.  $V_{CO}$

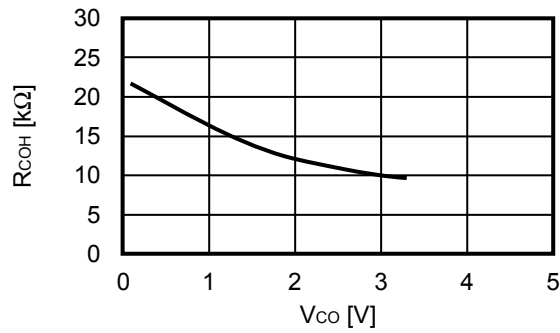

4.2  $R_{COL}$  vs.  $V_{CO}$

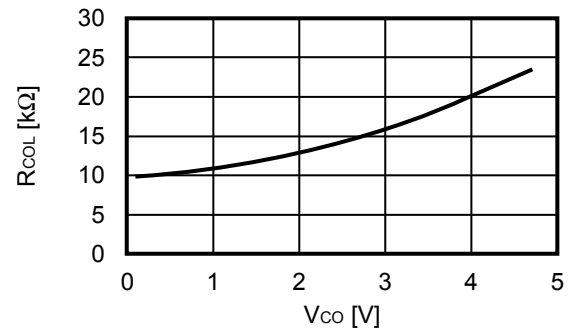

4.3  $R_{DOH}$  vs.  $V_{DO}$

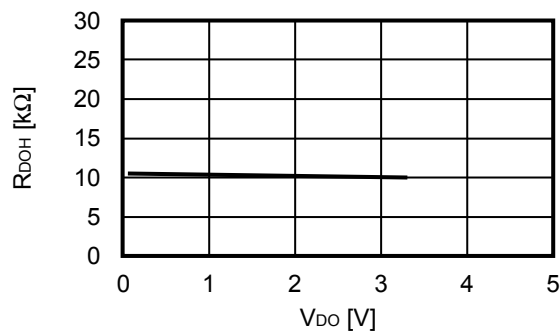

4.4  $R_{DOL}$  vs.  $V_{DO}$

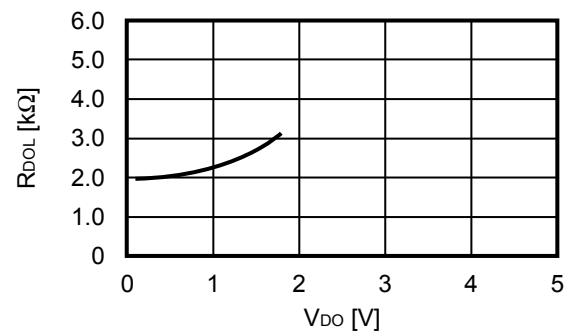

■ **Marking Specifications**

1. **SNT-6A**

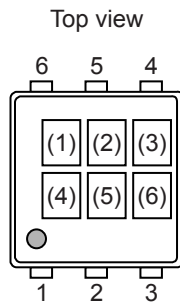

(1) to (3): Product code (refer to **Product name vs. Product code**)

(4) to (6): Lot number

**Product name vs. Product code**

Product Name	Product Code		
	(1)	(2)	(3)
S-82F1BAD-I6T1U	7	E	D
S-82F1BAE-I6T1U	7	E	E
S-82F1BAF-I6T1U	7	E	F
S-82F1BAG-I6T1U	7	E	G
S-82F1BAH-I6T1U	7	E	H
S-82F1BAK-I6T1U	7	E	K
S-82F1BAN-I6T1U	7	E	N
S-82F1BAO-I6T1U	7	E	O
S-82F1BAQ-I6T1U	7	E	Q

■ Power Dissipation

SNT-6A

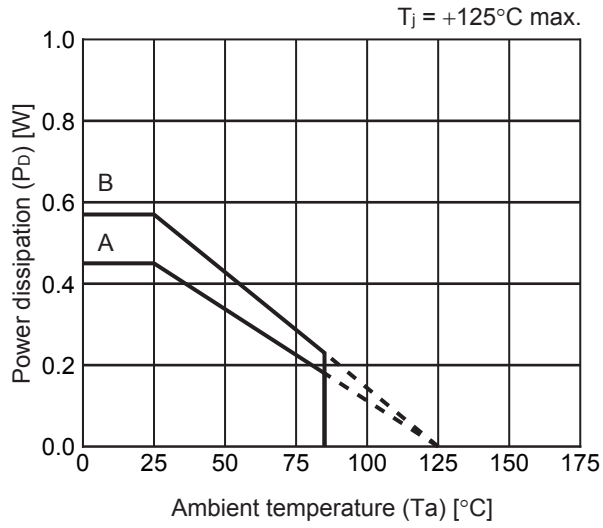

Board	Power Dissipation ( $P_D$ )
A	0.45 W
B	0.57 W
C	-
D	-
E	-

# SNT-6A Test Board

(1) Board A

 IC Mount Area

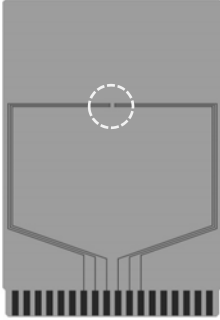

Item		Specification
Size [mm]		114.3 x 76.2 x t1.6
Material		FR-4
Number of copper foil layer		2
Copper foil layer [mm]	1	Land pattern and wiring for testing: t0.070
	2	-
	3	-
	4	74.2 x 74.2 x t0.070
Thermal via		-

(2) Board B

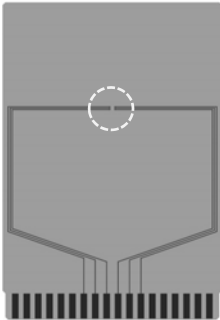

Item		Specification
Size [mm]		114.3 x 76.2 x t1.6
Material		FR-4
Number of copper foil layer		4
Copper foil layer [mm]	1	Land pattern and wiring for testing: t0.070
	2	74.2 x 74.2 x t0.035
	3	74.2 x 74.2 x t0.035
	4	74.2 x 74.2 x t0.070
Thermal via		-

No. SNT6A-A-Board-SD-1.0



No. PG006-A-P-SD-2.1

TITLE	SNT-6A-A-PKG Dimensions
No.	PG006-A-P-SD-2.1
ANGLE	
UNIT	mm
<b>ABLIC Inc.</b>	



Feed direction →

No. PG006-A-C-SD-2.0

TITLE	SNT-6A-A-Carrier Tape
No.	PG006-A-C-SD-2.0
ANGLE	
UNIT	mm
<b>ABLIC Inc.</b>	





Enlarged drawing in the central part



No. PG006-A-R-SD-1.0

TITLE	SNT-6A-A-Reel		
No.	PG006-A-R-SD-1.0		
ANGLE		QTY.	5,000
UNIT	mm		
<b>ABLIC Inc.</b>			



※1. ランドパターンの幅に注意してください (0.25 mm min. / 0.30 mm typ.).  
 ※2. パッケージ中央にランドパターンを広げないでください (1.30 mm ~ 1.40 mm)。

- 注意
1. パッケージのモールド樹脂下にシルク印刷やハンダ印刷などしないでください。
  2. パッケージ下の配線上のソルダーレジストなどの厚みをランドパターン表面から0.03 mm 以下にしてください。
  3. マスク開口サイズと開口位置はランドパターンと合わせてください。
  4. 詳細は "SNTパッケージ活用の手引き" を参照してください。

※1. Pay attention to the land pattern width (0.25 mm min. / 0.30 mm typ.).  
 ※2. Do not widen the land pattern to the center of the package ( 1.30 mm ~ 1.40 mm ).

- Caution**
1. Do not do silkscreen printing and solder printing under the mold resin of the package.
  2. The thickness of the solder resist on the wire pattern under the package should be 0.03 mm or less from the land pattern surface.
  3. Match the mask aperture size and aperture position with the land pattern.
  4. Refer to "SNT Package User's Guide" for details.

※1. 请注意焊盘模式的宽度 (0.25 mm min. / 0.30 mm typ.).  
 ※2. 请勿向封装中间扩展焊盘模式 (1.30 mm ~ 1.40 mm)。

- 注意
1. 请勿在树脂型封装的下面印刷丝网、焊锡。
  2. 在封装下、布线上的阻焊膜厚度 (从焊盘模式表面起) 请控制在 0.03 mm 以下。
  3. 钢网的开口尺寸和开口位置请与焊盘模式对齐。
  4. 详细内容请参阅 "SNT 封装的应用指南"。

No. PG006-A-L-SD-4.1

TITLE	SNT-6A-A -Land Recommendation
No.	PG006-A-L-SD-4.1
ANGLE	
UNIT	mm
<b>ABLIC Inc.</b>	

## Disclaimers (Handling Precautions)

1. All the information described herein (product data, specifications, figures, tables, programs, algorithms and application circuit examples, etc.) is current as of publishing date of this document and is subject to change without notice.
2. The circuit examples and the usages described herein are for reference only, and do not guarantee the success of any specific mass-production design.  
ABLIC Inc. is not liable for any losses, damages, claims or demands caused by the reasons other than the products described herein (hereinafter "the products") or infringement of third-party intellectual property right and any other right due to the use of the information described herein.
3. ABLIC Inc. is not liable for any losses, damages, claims or demands caused by the incorrect information described herein.
4. Be careful to use the products within their ranges described herein. Pay special attention for use to the absolute maximum ratings, operation voltage range and electrical characteristics, etc.  
ABLIC Inc. is not liable for any losses, damages, claims or demands caused by failures and / or accidents, etc. due to the use of the products outside their specified ranges.
5. Before using the products, confirm their applications, and the laws and regulations of the region or country where they are used and verify suitability, safety and other factors for the intended use.
6. When exporting the products, comply with the Foreign Exchange and Foreign Trade Act and all other export-related laws, and follow the required procedures.
7. The products are strictly prohibited from using, providing or exporting for the purposes of the development of weapons of mass destruction or military use. ABLIC Inc. is not liable for any losses, damages, claims or demands caused by any provision or export to the person or entity who intends to develop, manufacture, use or store nuclear, biological or chemical weapons or missiles, or use any other military purposes.
8. The products are not designed to be used as part of any device or equipment that may affect the human body, human life, or assets (such as medical equipment, disaster prevention systems, security systems, combustion control systems, infrastructure control systems, vehicle equipment, traffic systems, in-vehicle equipment, aviation equipment, aerospace equipment, and nuclear-related equipment), excluding when specified for in-vehicle use or other uses by ABLIC, Inc. Do not apply the products to the above listed devices and equipments.  
ABLIC Inc. is not liable for any losses, damages, claims or demands caused by unauthorized or unspecified use of the products.
9. In general, semiconductor products may fail or malfunction with some probability. The user of the products should therefore take responsibility to give thorough consideration to safety design including redundancy, fire spread prevention measures, and malfunction prevention to prevent accidents causing injury or death, fires and social damage, etc. that may ensue from the products' failure or malfunction.  
The entire system in which the products are used must be sufficiently evaluated and judged whether the products are allowed to apply for the system on customer's own responsibility.
10. The products are not designed to be radiation-proof. The necessary radiation measures should be taken in the product design by the customer depending on the intended use.
11. The products do not affect human health under normal use. However, they contain chemical substances and heavy metals and should therefore not be put in the mouth. The fracture surfaces of wafers and chips may be sharp. Be careful when handling these with the bare hands to prevent injuries, etc.
12. When disposing of the products, comply with the laws and ordinances of the country or region where they are used.
13. The information described herein contains copyright information and know-how of ABLIC Inc. The information described herein does not convey any license under any intellectual property rights or any other rights belonging to ABLIC Inc. or a third party. Reproduction or copying of the information from this document or any part of this document described herein for the purpose of disclosing it to a third-party is strictly prohibited without the express permission of ABLIC Inc.
14. For more details on the information described herein or any other questions, please contact ABLIC Inc.'s sales representative.
15. This Disclaimers have been delivered in a text using the Japanese language, which text, despite any translations into the English language and the Chinese language, shall be controlling.

2.4-2019.07