

DATA SHEET

EQ38/8/25

EQ cores and accessories

New data

2008 Sep 01



FERROXCUBE
A YAGEO COMPANY

CORES

Effective core parameters of a set of EQ cores

SYMBOL	PARAMETER	VALUE	UNIT
$\Sigma(l/A)$	core factor (C1)	0.341	mm ⁻¹
V_e	effective volume	7900	mm ³
l_e	effective length	51.9	mm
A_e	effective area	152	mm ²
A_{min}	minimum area	119	mm ²
m	mass of core half	≈ 21.5	g

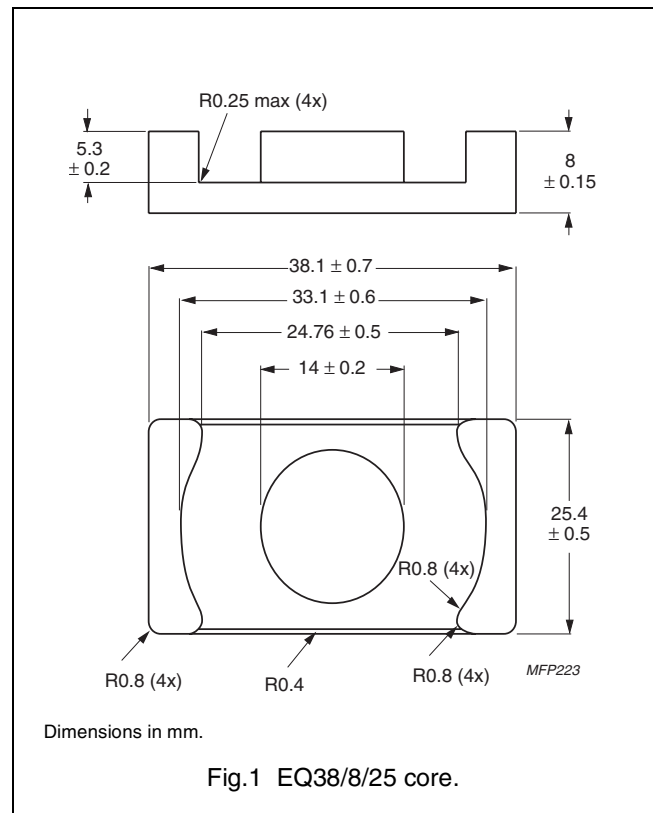

Effective core parameters of an EQ/PLT combination

SYMBOL	PARAMETER	VALUE	UNIT
$\Sigma(l/A)$	core factor (C1)	0.282	mm ⁻¹
V_e	effective volume	6190	mm ³
l_e	effective length	41.7	mm
A_e	effective area	148	mm ²
A_{min}	minimum area	119	mm ²
m	mass of plate	≈ 14.6	g



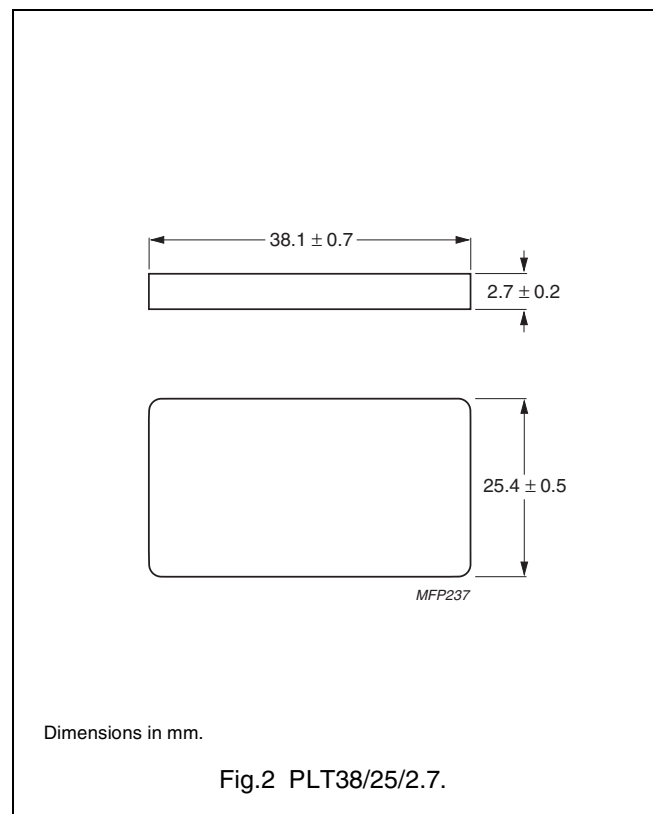

Ordering information for plates

GRADE	TYPE NUMBER
3C94	PLT38/25/2.7-3C94
3C95 <small>des</small>	PLT38/25/2.7-3C95
3C96 <small>des</small>	PLT38/25/2.7-3C96
3F35 <small>des</small>	PLT38/25/2.7-3F35
3F4 <small>des</small>	PLT38/25/2.7-3F4
3F45 <small>prot</small>	PLT38/25/2.7-3F45







Core halves for use in combination with an EQ core

A_L measured in combination with a non-gapped core half, clamping force for A_L measurements, 50 ± 20 N.

GRADE	A_L (nH)	μ_e	AIR GAP (μm)	TYPE NUMBER
3C94	$7000 \pm 25 \%$	≈ 1900	≈ 0	EQ38/8/25-3C94
3C95 	$8810 \pm 25 \%$	≈ 2395	≈ 0	EQ38/8/25-3C95
3C96 	$6300 \pm 25 \%$	≈ 1710	≈ 0	EQ38/8/25-3C96
3F35 	$4500 \pm 25 \%$	≈ 1220	≈ 0	EQ38/8/25-3F35
3F4 	$3000 \pm 25 \%$	≈ 815	≈ 0	EQ38/8/25-3F4
3F45 	$3000 \pm 25 \%$	≈ 815	≈ 0	EQ38/8/25-3F45

Core halves for use in combination with a plate (PLT)

A_L measured in combination with a plate (PLT), clamping force for A_L measurements, 50 ± 20 N.

GRADE	A_L (nH)	μ_e	AIR GAP (μm)	TYPE NUMBER
3C94	$8200 \pm 25 \%$	≈ 1840	≈ 0	PLT38/25/2.7-3C94
3C95 	$10220 \pm 25 \%$	≈ 2295	≈ 0	PLT38/25/2.7-3C95
3C96 	$7400 \pm 25 \%$	≈ 1660	≈ 0	PLT38/25/2.7-3C96
3F35 	$5300 \pm 25 \%$	≈ 1190	≈ 0	PLT38/25/2.7-3F35
3F4 	$3500 \pm 25 \%$	≈ 785	≈ 0	PLT38/25/2.7-3F4
3F45 	$3500 \pm 25 \%$	≈ 785	≈ 0	PLT38/25/2.7-3F45

Properties of core sets under power conditions

CORE COMBINATION	B (mT) at	CORE LOSS (W) at			
	H = 250 A/m; f = 10 kHz; T = 100 °C	f = 100 kHz; \hat{B} = 100 mT; T = 100 °C	f = 100 kHz; \hat{B} = 200 mT; T = 25 °C	f = 100 kHz; \hat{B} = 200 mT; T = 100 °C	f = 500 kHz; \hat{B} = 50 mT; T = 100 °C
EQ+EQ38-3C94	≥ 320	≤ 0.72	≤ 4.8	–	–
EQ+PLT38-3C94	≥ 320	≤ 0.56	≤ 3.8	–	–
EQ+EQ38-3C95	≥ 320	–	≤ 4.66	≤ 4.42	–
EQ+PLT38-3C95	≥ 320	–	≤ 3.65	≤ 3.47	–
EQ+EQ38-3C96	≥ 340	≤ 0.52	–	≤ 3.5	≤ 3.1
EQ+PLT38-3C96	≥ 340	≤ 0.42	–	≤ 2.8	≤ 2.4
EQ+EQ38-3F35	≥ 300	–	–	–	≤ 1.2
EQ+PLT38-3F35	≥ 300	–	–	–	≤ 0.94

Properties of core sets under power conditions (continued)

CORE COMBINATION	B (mT) at	CORE LOSS (W) at			
	H = 250 A/m; f = 10 kHz; T = 100 °C	f = 500 kHz; \hat{B} = 100 mT; T = 100 °C	f = 1 MHz; \hat{B} = 30 mT; T = 100 °C	f = 1 MHz; \hat{B} = 50 mT; T = 100 °C	f = 3 MHz; \hat{B} = 10 mT; T = 100 °C
EQ+EQ38-3F35	≥ 300	≤ 8.9	–	–	–
EQ+PLT38-3F35	≥ 300	≤ 7.0	–	–	–
EQ+EQ38-3F4	≥ 300	–	≤ 4.1	–	≤ 5.8
EQ+PLT38-3F4	≥ 300	–	≤ 3.2	–	≤ 4.6
EQ+EQ38-3F45	≥ 300	–	≤ 3.2	≤ 12	≤ 4.7
EQ+PLT38-3F45	≥ 300	–	≤ 2.5	≤ 9.0	≤ 3.7



DATA SHEET STATUS DEFINITIONS

DATA SHEET STATUS	PRODUCT STATUS	DEFINITIONS
Preliminary specification	Development	This data sheet contains preliminary data. Ferroxcube reserves the right to make changes at any time without notice in order to improve design and supply the best possible product.
Product specification	Production	This data sheet contains final specifications. Ferroxcube reserves the right to make changes at any time without notice in order to improve design and supply the best possible product.

DISCLAIMER

Life support applications — These products are not designed for use in life support appliances, devices, or systems where malfunction of these products can reasonably be expected to result in personal injury. Ferroxcube customers using or selling these products for use in such applications do so at their own risk and agree to fully indemnify Ferroxcube for any damages resulting from such application.

PRODUCT STATUS DEFINITIONS

STATUS	INDICATION	DEFINITION
Prototype		These are products that have been made as development samples for the purposes of technical evaluation only. The data for these types is provisional and is subject to change.
Design-in		These products are recommended for new designs.
Preferred		These products are recommended for use in current designs and are available via our sales channels.
Support		These products are not recommended for new designs and may not be available through all of our sales channels. Customers are advised to check for availability.