

# MICRODC

Professional Power Module

## WRA-ZMD-6W&WRB-ZMD-6W Series

6W, 4:1 WIDE INPUT, ISOLATED & REGULATED DUAL & SINGLE OUTPUT DC-DC CONVERTER

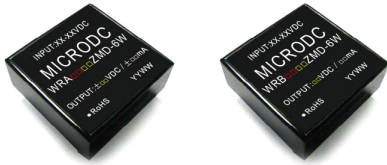

### FEATURES

- ◆ DIP package
- ◆ 1500VDC isolation
- ◆ Short circuit protection (automatic recovery)
- ◆ Operating temperature: -40°C to +85°C
- ◆ Internal SMD construction
- ◆ Metal shielding package
- ◆ Industry standard pinout
- ◆ No heat sink required
- ◆ MTBF>1,000,000 hours
- ◆ RoHS Compliance

### MODEL SELECTION

**WRA<sup>①</sup>24<sup>②</sup>05<sup>③</sup>Z<sup>④</sup>M<sup>⑤</sup>D<sup>⑥</sup>-6W<sup>⑦</sup>**

- ① Product Series
- ② Input Voltage
- ③ Output Voltage 1st
- ④ Wide (4:1) Input Range
- ⑤ Metal Shield
- ⑥ DIP Package Style
- ⑦ Rated Power

### APPLICATIONS

The WRA\_ZMD-6W & WRB\_ZMD-6W Series are specially designed for applications where a wide range input voltage power supplies are isolated from the input power supply in a distributed power supply system on a circuit board.

These products apply to:

- 1) Where the voltage of the input power supply is wide range (voltage range ≤4:1);
- 2) Where isolation is necessary between input and output(isolation voltage ≤1500VDC);
- 3) Where the regulation of the output voltage and the output ripple noise are demanded.

### SELECTION GUIDE

Order code	Input Voltage(VDC)			Output			Efficiency (% Typ)
	Nominal	Range	Max.*	Voltage (VDC)	Current(mA)		
					Max.	Min.	
WRA2405ZMD-6W	24	9-36	40	±5	±600	±60	80
WRA2412ZMD-6W	24	9-36	40	±12	±250	±25	82
WRA2415ZMD-6W	24	9-36	40	±15	±200	±20	84
WRA2424ZMD-6W	24	9-36	40	±24	±125	±13	82
WRB2405ZMD-6W	24	9-36	40	5	1200	120	80
WRB2412ZMD-6W	24	9-36	40	12	500	50	82
WRB2415ZMD-6W	24	9-36	40	15	400	40	84
WRB2424ZMD-6W	24	9-36	40	24	250	25	82
WRA4805ZMD-6W	48	18-72	80	±5	±600	±60	80
WRA4812ZMD-6W	48	18-72	80	±12	±250	±25	82
WRA4815ZMD-6W	48	18-72	80	±15	±200	±20	84
WRB4805ZMD-6W	48	18-72	80	5	1200	120	80
WRB4812ZMD-6W	48	18-72	80	12	500	50	82
WRB4815ZMD-6W	48	18-72	80	15	400	40	84

\*Input voltage can't exceed this value, or will cause the permanent damage.

### COMMON SPECIFICATIONS

Parameter	Test conditions	Min.	Typ.	Max.	Units
Storage humidity				95	%
Operating temperature		-40		85	°C
Storage temperature		-55		125	°C
Temp. rise at full load			40		°C
Lead temperature	1.5mm from case for 10 seconds			300	°C
Cooling		Free air convection			
Short circuit protection		Continuous, automatic recovery			
Case material		Aluminum			
MTBF		1000			K hours
Weight			15		g

### ISOLATION SPECIFICATIONS

Parameter	Test conditions	Min.	Typ.	Max.	Units
Isolation voltage	Tested for 1 minute and 1 mA max	1500			VDC
Isolation resistance	Test at 500VDC	1000			MΩ
Isolation capacitance	Input/Output, 100KHz/1V		100		pF



**CE REACH**  
MICRODC reserves the copyright

### OUTPUT SPECIFICATIONS

Parameter	Test conditions	Min.	Typ.	Max	Units
Output power	See above products program	0.6		6	W
Line regulation (at full load)	Input voltage from low to high		±0.2	±0.5	%
Load regulation	Form 10% to 100%load		±0.5	±2*	%
Positive output voltage accuracy	Refer to recommended circuit		±1	±3	%
Negative output voltage accuracy	Refer to recommended circuit		±3	±5	%
Temperature Drift (Vout)	Refer to recommended circuit		±0.02		%/°C
Ripple**	20MHz Bandwidth		30	50	mVp-p
Noise**	20MHz Bandwidth		75	150	mVp-p
Switching frequency	100% load, input voltage range		300		KHz

\* Dual output models unbalanced load: ±5%.

\*\*Test ripple and noise by “parallel cable” method. See detailed operation instructions at Testing of Power Converter section, application notes.

### TYPICAL TEMPERATURE CURVE

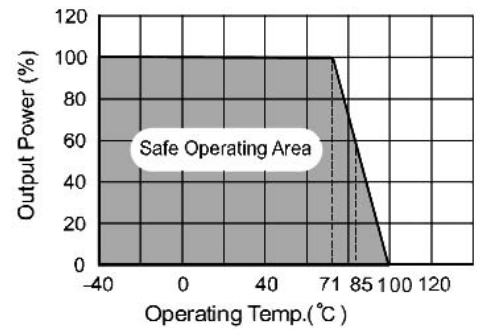

### APPLICATION NOTE

#### 1) Requirement on output load

In order to ensure the product operate efficiently and reliably, in addition to a max load (namelyull load), a minimum load is specified for this kind of DC/DC converter. Make sure the specified range of input voltage is not exceeded, the minimum output load no less than 10% load. If the actual load is less than the specified minimum load, the output ripple may increase sharply while its efficiency and reliability will reduce greatly. If the actual output power is very small, please add an appropriate resistor as extra loading, or contact our company for other lower output power products.

#### 2) Recommended Circuit

All the WRA\_ZMD-6W & WRB\_ZMD-6W series have been tested according to the following recommended testing circuit before leaving factory. This series should be tested under load (see Figure 1).

If you want to further decrease the input/output ripple, you can increase capacitance properly or choose capacitors with low ESR. However, the capacitance should not be too high, or may cause start-up problem. For every channel of output, provided the safe and reliable operation is ensured, the greatest capacitance of its filter capacitor sees (Table 1). General:

Cin: 24V&48V 10μF~47μF

Cout: 10μF/100mA

#### 3) Input current

While using unstable power source, please ensure the output voltage and ripple voltage do not exceed indexes of the converter. The preceding power source must be able to provide for converter sufficient starting current Ip (Figure 2).

General:  $I_p \leq 1.4 \cdot I_{in-max}$

#### 4) No parallel connection or plug and play

### RECOMMENDED CIRCUIT

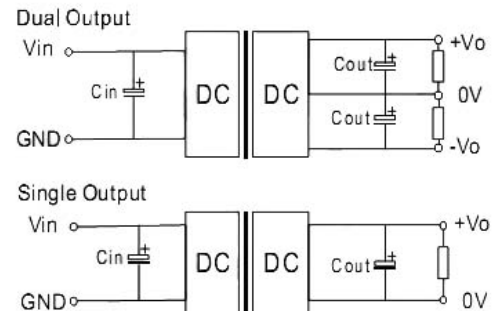

(Figure 1)

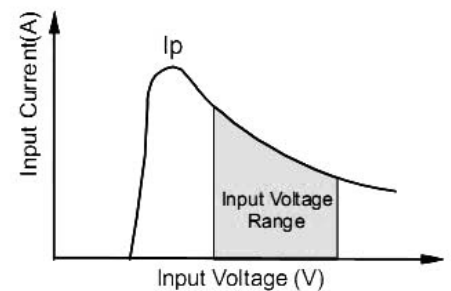

(Figure 2)

External Capacitor Table (Table 1)

Single Vout (VDC)	Cout (μF)	Dual Vout (VDC)	Cout (μF)
5	1000	±5	680
12	470	±12	330
15	330	±15	220
24	220	±24	100

### OUTLINE DIMENSIONS & FOOTPRINT DETAILS

#### MECHANICAL DIMENSIONS

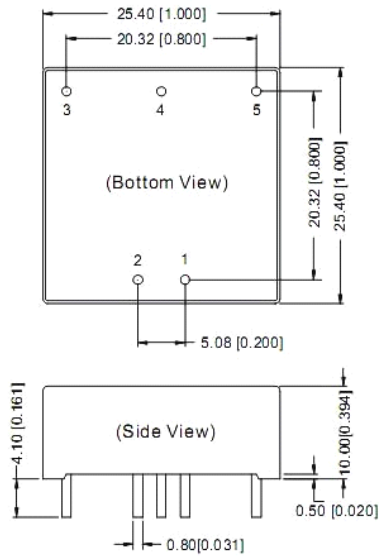

Note:  
Unit:mm[inch]  
Pin diameter tolerances:±0.10mm[±0.004inch]  
General tolerances:±0.25mm[±0.010inch]

FOOTPRINT DETAILS		
Pin	Single	Dual
1	GND	GND
2	Vin	Vin
3	+Vo	+Vo
4	No Pin	0V
5	0V	-Vo

NC:No connection

#### RECOMMENDED FOOTPRINT(TOP VIEW)

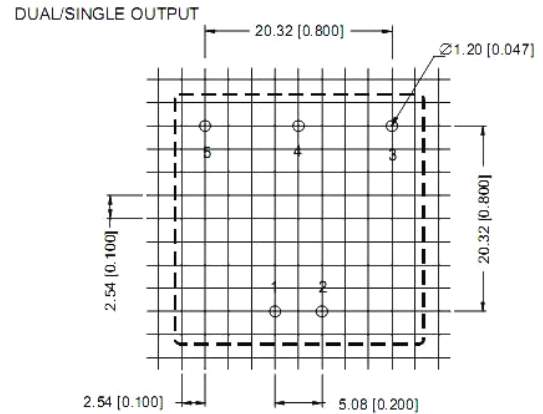

#### TUBE OUTLINE DIMENSIONS

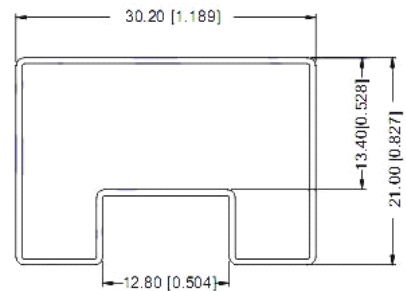

Note:  
Unit :mm[inch]  
General tolerances: ±0.50mm[±0.020inch]  
L=530mm[20.866inch] Tube Quantity: 19pcs  
L=220mm[8.661inch] Tube Quantity: 7pcs

Note:

1. The load shouldn't be less than 10%, otherwise ripple will increase dramatically.
2. Operation under 10% load will not damage the converter; However, they may not meet all specification listed.
3. Capacitor MAX load tested at input voltage range and full load.
4. All specifications measured at Ta=25°C, humidity<75%, nominal input voltage and rated output load unless otherwise specified.
5. In this datasheet, all the test methods of indications are based on corporate standards.
6. Only typical models listed, other models may be different, please contact our technical person for more details.

# MICRODC

Professional Power Module

Microdc Professional Power Module, Inc.

Tel:0086-20-86000646 E-mail:tech@microdc.cn

Website:http://www.microdc.cn

Microdc Professional Power module, Inc. makes no representation that the use of its products in the circuits described herein, or the use of other technical information contained herein, will not infringe upon existing or future patent rights. Specifications are subject to change without notice.

©2010 Microdc Professional Power Module, Inc. Guangzhou



#### RoHS COMPLIANT INFORMATION

This series is compatible with RoHS soldering systems with a peak wave solder temperature of 300°C for 10 seconds. The pin termination finish on the SIP package type is Tin Plate, Hot Dipped over Matte Tin with Nickel Preplate. The DIP types are Matte Tin over Nickel Preplate. Both types in this series are backward compatible with Sn/Pb soldering systems.



#### REACH COMPLIANT INFORMATION

This series has proven that this product does not contain harmful chemicals, it also has harmful chemical substances through the registration, inspection and approval.