

SMDD-200H

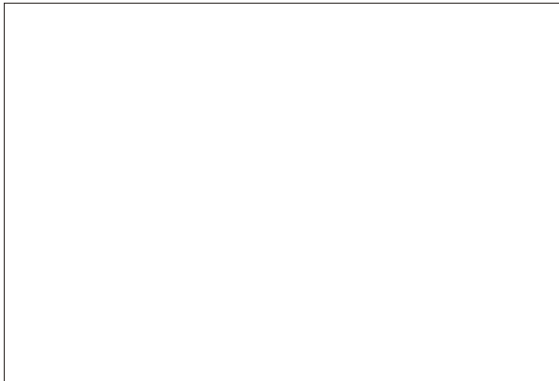

Diode-Diode Module



Type	V_{RSM}	V_{RRM}
SMDD-200H-08	1000	800
SMDD-200H-12	1400	1200
SMDD-200H-14	1600	1400
SMDD-200H-16	1800	1600
SMDD-200H-18	2000	1800
SMDD-200H-20	2200	2000
SMDD-200H-22	2400	2200
SMDD-200H-24	2600	2400

Type	I_{FAVM}	I_{FRMS}	T_C	I_{FSM}	i^2t	V_{TM}	I_{FM}	V_{FO}	r_F	T_{VJM}	V_{isol}	R_{thJC}
	A	A	°C	KA	KA ² s	V	A	V	mΩ	°C	V	K/W
SMDD-200H	200	314	100	8	240	1.38	600	0.8	0.8	150	2500	0.21

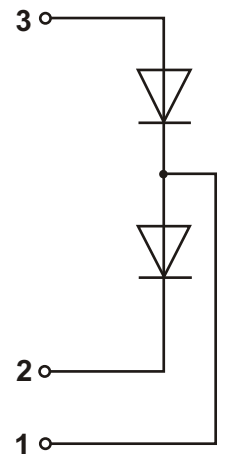
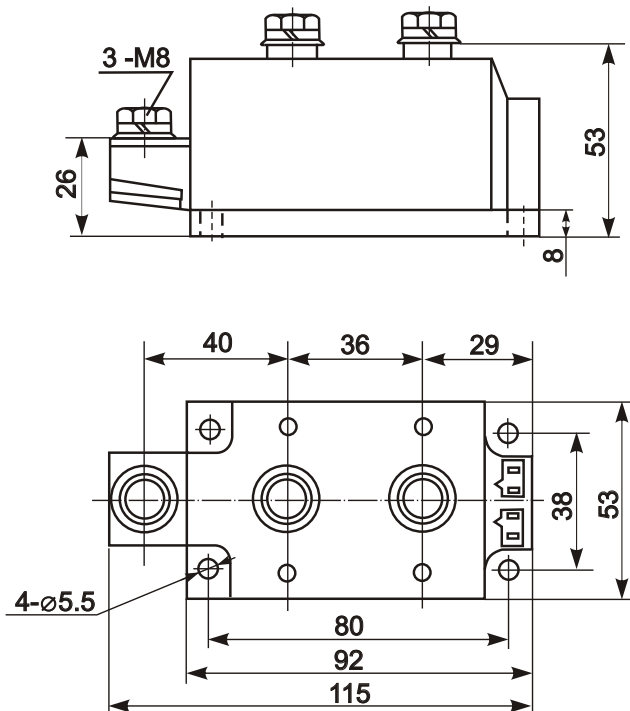

Features:

- Industrial standard package
- Heat transfer through aluminium nitride ceramic isolated metal baseplate
- Precise internal pressure contacts for high reliability
- 2500V RMS isolation voltage

Typical Applications:

- DC power supply for instrument and equipment
- Power converters
- Electronic welders
- Lighting control