

MOLDED WIREWOUND CHIP INDUCTORS

WI565050 SERIES

1. PART NO. EXPRESSION :

WI565050-1R0KF

- (a) Series code
- (b) Dimension code
- (c) Inductance code : 1R0 = 1.00uH
- (d) Tolerance code : J = ±5%, K = ±10%
- (e) F : Lead Free

2. CONFIGURATION & DIMENSIONS :

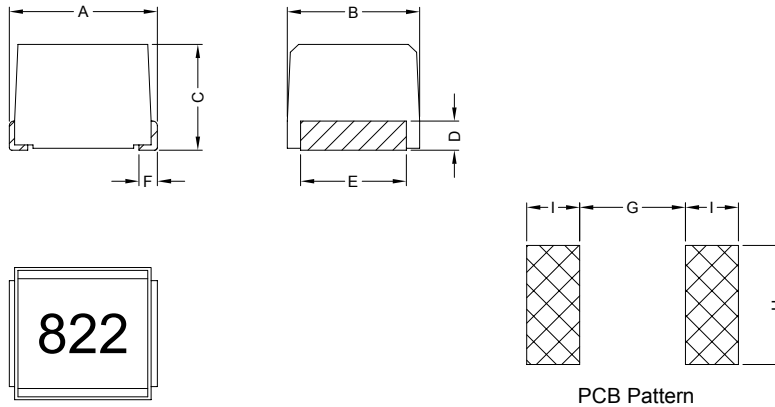

Unit:m/m

A	B	C	D	E	F	G	H	I
5.6±0.3	5.0±0.2	4.0±0.2	1.1 Ref.	4.0±0.2	0.7±0.1	4.0 Ref.	4.5 Ref.	2.0 Ref.

3. SCHEMATIC :

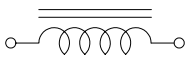

4. MATERIALS :

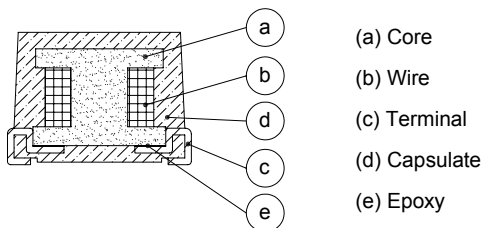

RoHS Compliant

NOTE : Specifications subject to change without notice. Please check our website for latest information.

16.10.2008



SUPERWORLD ELECTRONICS (S) PTE LTD

PG. 1

5. GENERAL SPECIFICATION :

- a) Temp. rise : 20°C Max.
- d) Operating temp. : -40°C to +125°C
- f) Rated current : Current cause inductance drop within 10%

6. ELECTRICAL CHARACTERISTICS :

Part No.	Inductance (μ H)	Q Min.	Test Frequency (MHz)	SRF (MHz) Min.	RDC (Ω) Max.	IDC (mA) Max.
WI565050-1R0KF	1.00 \pm 10%	10	7.96	95	0.030	1800
WI565050-1R2KF	1.20 \pm 10%	10	7.96	70	0.035	1700
WI565050-1R5KF	1.50 \pm 10%	10	7.96	55	0.04	1600
WI565050-1R8KF	1.80 \pm 10%	10	7.96	47	0.05	1400
WI565050-2R2KF	2.20 \pm 10%	10	7.96	42	0.06	1300
WI565050-2R7KF	2.70 \pm 10%	10	7.96	37	0.07	1200
WI565050-3R3KF	3.30 \pm 10%	10	7.96	34	0.08	1120
WI565050-3R9KF	3.90 \pm 10%	10	7.96	32	0.09	1050
WI565050-4R7KF	4.70 \pm 10%	10	7.96	29	0.11	950
WI565050-5R6KF	5.60 \pm 10%	10	7.96	26	0.13	880
WI565050-6R8KF	6.80 \pm 10%	10	7.96	24	0.15	810
WI565050-8R2KF	8.20 \pm 10%	10	7.96	22	0.18	750
WI565050-100KF	10.00 \pm 10%	10	2.52	19	0.21	690
WI565050-120KF	12.00 \pm 10%	10	2.52	17	0.25	630
WI565050-150KF	15.00 \pm 10%	10	2.52	16	0.30	580
WI565050-180KF	18.00 \pm 10%	10	2.52	14	0.36	530
WI565050-220KF	22.00 \pm 10%	10	2.52	13	0.43	480
WI565050-270KF	27.00 \pm 10%	10	2.52	11.5	0.52	440
WI565050-330KF	33.00 \pm 10%	10	2.52	10.5	0.62	400
WI565050-390KF	39.00 \pm 10%	10	2.52	9.5	0.72	370
WI565050-470KF	47.00 \pm 10%	10	2.52	8.5	0.85	340
WI565050-560KF	56.00 \pm 10%	10	2.52	7.8	1.0	310
WI565050-680KF	68.00 \pm 10%	10	2.52	7.0	1.2	290
WI565050-820KF	82.00 \pm 10%	10	2.52	6.4	1.4	270



RoHS Compliant

NOTE : Specifications subject to change without notice. Please check our website for latest information.

16.10.2008



SUPERWORLD ELECTRONICS (S) PTE LTD

6. ELECTRICAL CHARACTERISTICS :

Part No.	Inductance (μ H)	Q Min.	Test Frequency (MHz)	SRF (MHz) Min.	RDC (Ω) Max.	IDC (mA) Max.
WI565050-101KF	100.00 \pm 10%	20	0.796	6.0	1.6	250
WI565050-121KF	120.00 \pm 10%	20	0.796	5.4	1.9	230
WI565050-151KF	150.00 \pm 10%	20	0.796	4.8	2.2	210
WI565050-181KF	180.00 \pm 10%	20	0.796	4.4	2.8	190
WI565050-221KF	220.00 \pm 10%	20	0.796	3.9	3.4	170
WI565050-271KF	270.00 \pm 10%	20	0.796	3.6	4.2	155
WI565050-331KF	330.00 \pm 10%	20	0.796	3.2	4.9	140
WI565050-391KF	390.00 \pm 10%	20	0.796	2.9	5.8	130
WI565050-471KF	470.00 \pm 10%	20	0.796	2.6	7.0	120
WI565050-561KF	560.00 \pm 10%	20	0.796	2.4	8.5	110
WI565050-681KF	680.00 \pm 10%	20	0.796	2.2	10	100
WI565050-821KF	820.00 \pm 10%	20	0.796	2.0	13	90
WI565050-102KF	1000.00 \pm 10%	20	0.252	1.8	15	85
WI565050-122JF	1200.00 \pm 5%	20	0.252	1.5	17	75
WI565050-152JF	1500.00 \pm 5%	20	0.252	1.4	20	70
WI565050-182JF	1800.00 \pm 5%	20	0.252	1.3	30	60
WI565050-222JF	2200.00 \pm 5%	20	0.252	1.2	35	55
WI565050-272JF	2700.00 \pm 5%	20	0.252	1.1	55	45
WI565050-332JF	3300.00 \pm 5%	20	0.252	1.0	60	40
WI565050-392JF	3900.00 \pm 5%	20	0.252	1.0	70	38
WI565050-472JF	4700.00 \pm 5%	20	0.252	0.9	78	36
WI565050-562JF	5600.00 \pm 5%	20	0.252	0.8	85	33
WI565050-682JF	6800.00 \pm 5%	20	0.252	0.7	110	30
WI565050-822JF	8200.00 \pm 5%	20	0.252	0.6	125	28
WI565050-103JF	10000.00 \pm 5%	15	0.0796	0.5	150	25



RoHS Compliant

NOTE : Specifications subject to change without notice. Please check our website for latest information.

16.10.2008



SUPERWORLD ELECTRONICS (S) PTE LTD

7. RELIABILITY TEST :

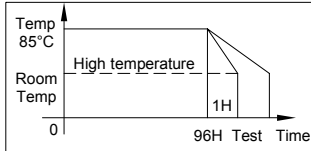
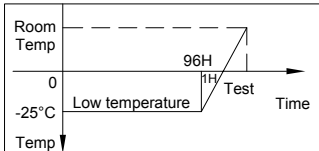
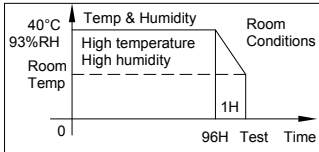
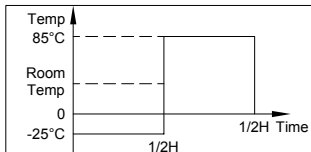
ITEM	PERFORMANCE	TEST CONDITION
Environmental Tests		
High Temperature Storage Test Reference documents: MIL-STD-202G Method 108A	1. No case deformation or change in appearance. 2. $\Delta L/L \leq 10\%$ 3. $\Delta Q/Q \leq 30\%$ 4. $\Delta DCR/DCR \leq 10\%$ or 15%	Temperature : $85 \pm 2^\circ\text{C}$ Time : 96 ± 2 hours Tested after 1 hour at room temperature 
Low Temperature Storage Test Reference documents: IEC 68-2-1A 6.1 6.2	1. No case deformation or change in appearance. 2. $\Delta L/L \leq 10\%$ 3. $\Delta Q/Q \leq 30\%$ 4. $\Delta DCR/DCR \leq 10\%$ or 15%	Temperature : $-25 \pm 2^\circ\text{C}$ Time : 96 ± 2 hours Tested after 1 hour at room temperature 
Humidity Test Reference documents: MIL-STD-202G Method 103B	1. No case deformation or change in appearance. 2. $\Delta L/L \leq 10\%$ 3. $\Delta Q/Q \leq 30\%$ 4. $\Delta DCR/DCR \leq 10\%$ or 15%	Temperature : $40 \pm 2^\circ\text{C}$ Humidity : $93 \pm 3\%$ RH Time : 96 ± 2 hours Tested after 1 hour at room temperature 
Thermal shock test Reference documents: MIL-STD-202G Method 107G	1. No case deformation or change in appearance. 2. $\Delta L/L \leq 10\%$ 3. $\Delta Q/Q \leq 30\%$ 4. $\Delta DCR/DCR \leq 10\%$ or 15%	Conditions of 1 cycle : Step 1 : -40°C for 30 minute Step 2 : 125°C for 30 minute Total : 20 cycles 
Physical Characteristics Tests		
Solderability Test Reference documents: MIL-STD-202G Method 208H IPC J-STD-002B	More than 95% of terminal electrode should be covered with solder.	Solder temperature : $245 \pm 5^\circ\text{C}$ Dip time : 5 secs. Solder : lead free Flux : rosin flux



RoHS Compliant

NOTE : Specifications subject to change without notice. Please check our website for latest information.

16.10.2008



SUPERWORLD ELECTRONICS (S) PTE LTD

PG. 4

7. RELIABILITY TEST :

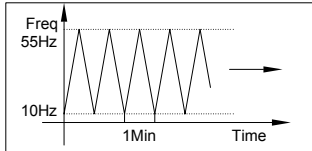
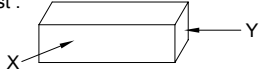
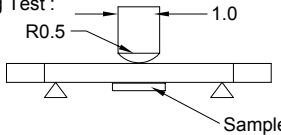
ITEM	PERFORMANCE	TEST CONDITION												
Heat Endurance of Reflow Soldering Reference documents: IPC J-STD-020B	1. No case deformation or change in appearance. 2. $\Delta L/L \leq 10\%$ 3. $\Delta Q/Q \leq 30\%$ 4. $\Delta DCR/DCR \leq 10\%$ or 15%	Refer to reflow curve. No. of cycle : 3 Peak temp. : $245 \pm 5^\circ\text{C}$												
Vibration Test Reference documents: MIL-STD-202G Method 201A	1. No case deformation or change in appearance. 2. $\Delta L/L \leq 10\%$ 3. $\Delta Q/Q \leq 30\%$ 4. $\Delta DCR/DCR \leq 10\%$ or 15%	Frequency : 10~55Hz Amplitude : 0.75mm Directions & times : X, Y, Z directions for 2 hours. A period of 2 hours in each of 3 mutually perpendicular directions (Total 6 hours). 												
Drop Test Reference documents: MIL-STD-202G Method 203C	1. No case deformation or change in appearance. 2. $\Delta L/L \leq 10\%$ 3. $\Delta Q/Q \leq 30\%$ 4. $\Delta DCR/DCR \leq 10\%$ or 15%	Drop from a height of 1m with 981m/s^2 (100G) altitude (1 angle, 1 ridge and 2 surface orientations)												
Terminal Strength Push Test Reference documents: JIS C 5321:1997	Pulling Test : A : Sectional area of terminal <table border="1" data-bbox="467 1070 852 1193"> <thead> <tr> <th>A</th> <th>Force</th> <th>Time (sec)</th> </tr> </thead> <tbody> <tr> <td>$A \leq 8\text{mm}^2$</td> <td>$\geq 5\text{N}$</td> <td>30</td> </tr> <tr> <td>$8\text{mm}^2 < A \leq 20\text{mm}^2$</td> <td>$\geq 10\text{N}$</td> <td>10</td> </tr> <tr> <td>$20\text{mm}^2 < A$</td> <td>$\geq 20\text{N}$</td> <td>10</td> </tr> </tbody> </table> Bending Test : The terminal electrode & the dielectric must not be damaged by the forces applied on the right conditions.	A	Force	Time (sec)	$A \leq 8\text{mm}^2$	$\geq 5\text{N}$	30	$8\text{mm}^2 < A \leq 20\text{mm}^2$	$\geq 10\text{N}$	10	$20\text{mm}^2 < A$	$\geq 20\text{N}$	10	Bend PCB at middle point, the deflection shall be 2mm. Pulling Test :  Bending Test :  Sample
A	Force	Time (sec)												
$A \leq 8\text{mm}^2$	$\geq 5\text{N}$	30												
$8\text{mm}^2 < A \leq 20\text{mm}^2$	$\geq 10\text{N}$	10												
$20\text{mm}^2 < A$	$\geq 20\text{N}$	10												

Reflow Curve

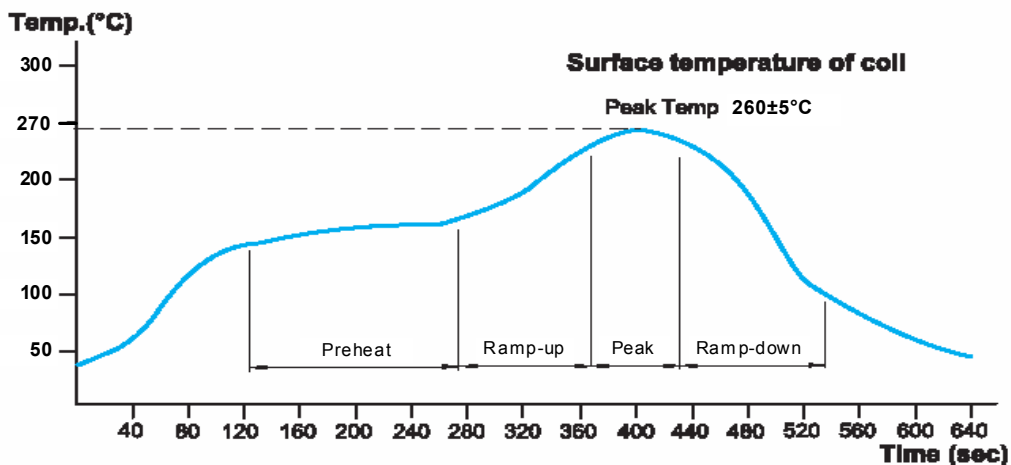

RoHS Compliant

NOTE : Specifications subject to change without notice. Please check our website for latest information.

16.10.2008



SUPERWORLD ELECTRONICS (S) PTE LTD

8. PACKAGING INFORMATION : (Unit : mm)

8-1. Reel & Tape Dimension

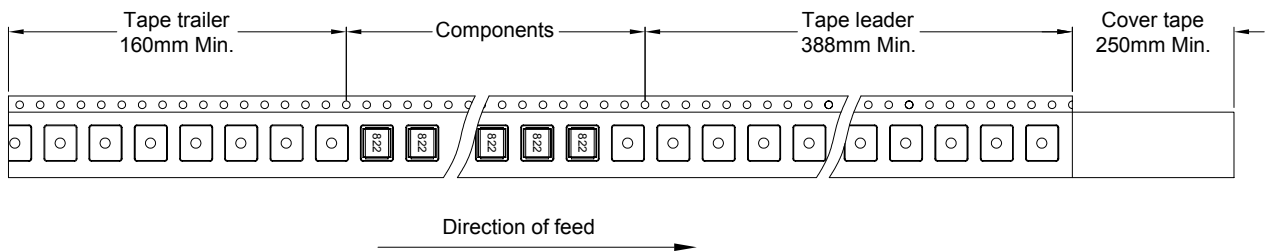
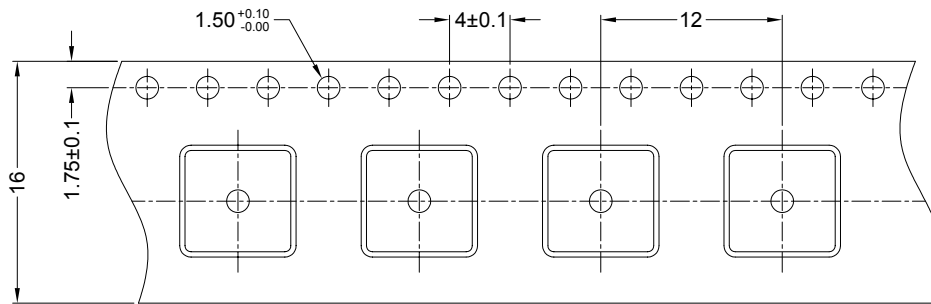
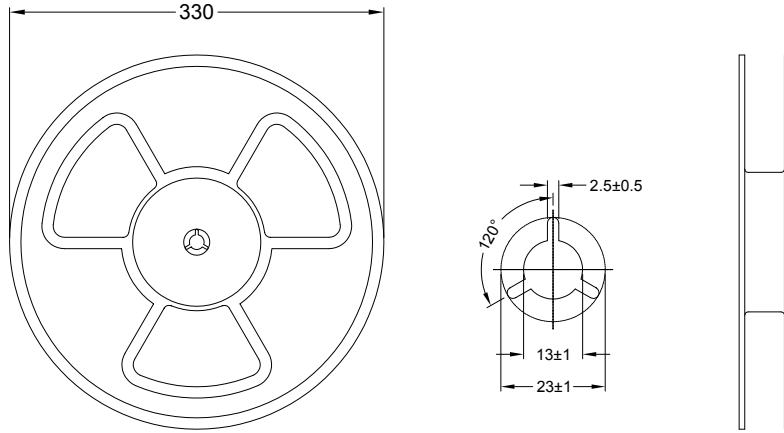

8-2. Quantity & G.W. per package

SERIES	INNER : REEL		OUTER : CARTON		
	Q'TY (PCS)	G.W. (Kg)	Q'TY (PCS)	G.W. (Kg)	SIZE (cm)
WI565050	1000	0.76	16000	14	36 x 36 x 40



RoHS Compliant

NOTE : Specifications subject to change without notice. Please check our website for latest information.

16.10.2008



SUPERWORLD ELECTRONICS (S) PTE LTD