

**PLEASE CHECK WWW.MOLEX.COM FOR LATEST PART INFORMATION**

**Part Number:** [0908793504](#)  
**Status:** **Active**  
**Overview:** [rast 5 connector system](#)  
**Description:** 5.00mm (.197") Pitch Appli-Mate RAST 5 Header, Right Angle, Male, Natural, Unblocked Position Key: 2B, Unblocked Coding Keys: D20 & D60 Latch Position 1/2 5/6, 7 Circuits

**Documents:**

[3D Model](#) [Product Specification PS-99020-0037 \(PDF\)](#)  
[Packaging Specification \(PDF\)](#) [RoHS Certificate of Compliance \(PDF\)](#)  
[Drawing \(PDF\)](#)

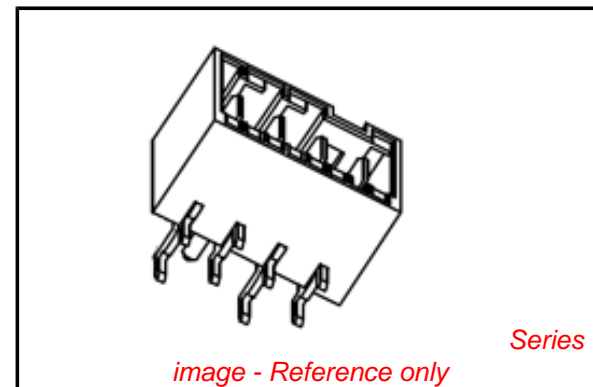

image - Reference only

**Agency Certification**

CSA LR19980  
 UL E29179

**General**

Product Family PCB Headers  
 Series [90879](#)  
 Application Wire-to-Board  
 Comments Male Indirect Receptacle Reference K32  
 Overview [rast 5 connector system](#)  
 Product Name RAST 5

**Physical**

Breakaway No  
 Circuits (Loaded) 7  
 Circuits (maximum) 7  
 Color - Resin Natural  
 Durability (mating cycles max) 10  
 First Mate / Last Break No  
 Flammability 94V-0  
 Glow-Wire Compliant No  
 Guide to Mating Part No  
 Keying to Mating Part None  
 Lock to Mating Part Yes  
 Material - Metal Brass  
 Material - Plating Mating Tin  
 Material - Plating Termination Tin  
 Material - Resin Polyester  
 Number of Rows 1  
 Orientation Right Angle  
 PC Tail Length (in) 0.154 In  
 PC Tail Length (mm) 3.90 mm  
 PCB Locator No  
 PCB Retention N/A  
 PCB Thickness Recommended (in) 0.055 In  
 PCB Thickness Recommended (mm) 1.40 mm  
 Packaging Type Bag  
 Pitch - Mating Interface (in) 0.197 In  
 Pitch - Mating Interface (mm) 5.00 mm  
 Pitch - Term. Interface (in) 0.197 In  
 Pitch - Term. Interface (mm) 5.00 mm  
 Plating min: Mating (µin) 200  
 Plating min: Mating (µm) 5  
 Plating min: Termination (µin) 200

**EU RoHS**

**ELV and RoHS Compliant**  
**REACH SVHC Contains SVHC: No**  
**Halogen-Free Status**

**China RoHS**



**Need more information on product environmental compliance?**

Email [productcompliance@molex.com](mailto:productcompliance@molex.com)  
 For a multiple part number RoHS Certificate of Compliance, [click here](#)

Please visit the [Contact Us](#) section for any non-product compliance questions.

**Search Parts in this Series**

[90879Series](#)

**Mates With**

[91338](#) Appli-Mate Female Connector. Appli-Mate 5.0 IDT Connector System Female Receptacle [90833](#) , [90835](#). Appli-Mate RAST 5 IDT Housing [91777](#) , [91778](#)

Plating min: Termination (µm)	5
Polarized to Mating Part	Yes
Polarized to PCB	Yes
Shrouded	Fully
Stackable	No
Surface Mount Compatible (SMC)	No
Temperature Range - Operating	-20C TO +120C
Termination Interface: Style	Through Hole

### **Electrical**

Current - Maximum per Contact	16A
Voltage - Maximum	250V AC

### **Solder Process Data**

Duration at Max. Process Temperature (seconds)	10
Lead-free Process Capability	Wave Capable (TH only)
Process Temperature max. C	260

### **Material Info**

#### **Reference - Drawing Numbers**

Packaging Specification	PK-90858-001
Product Specification	PS-99020-0037
Sales Drawing	SD-90879-001

This document was generated on 05/26/2010

**PLEASE CHECK [WWW.MOLEX.COM](http://WWW.MOLEX.COM) FOR LATEST PART INFORMATION**

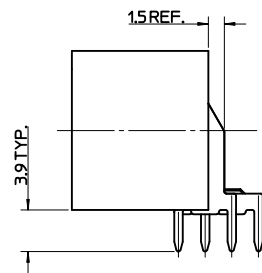
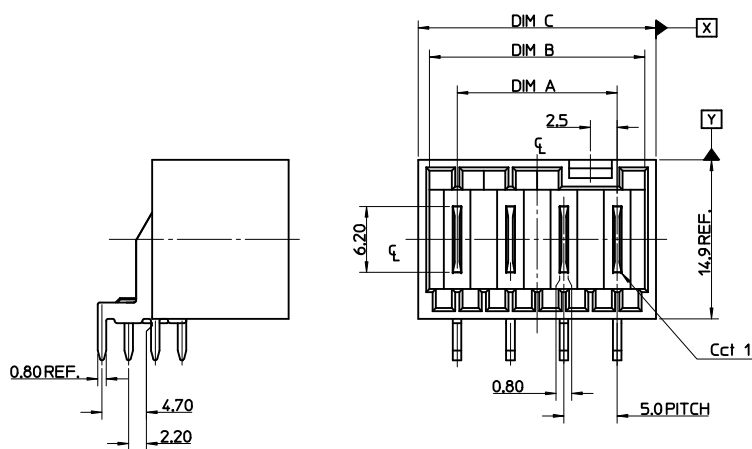

P.C.B.  
OPTION 'A'

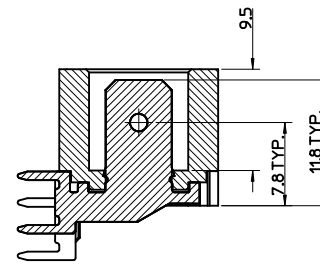
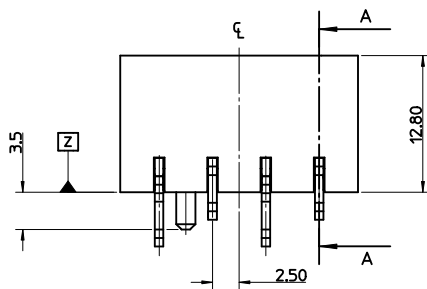
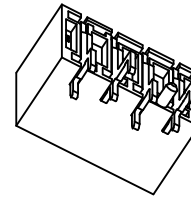

A-A  
Scale 3:1

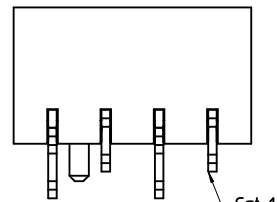

P.C.B.  
OPTION 'A'

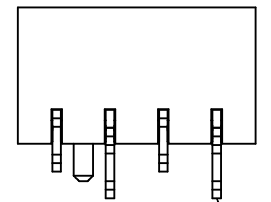

P.C.B.  
OPTION 'B'

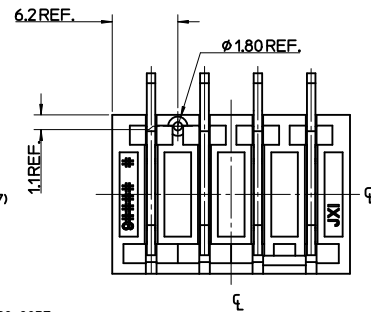

HOLES ON SOME  
TOOLED VERSIONS

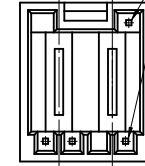

CCT	DIM A	DIM B	DIM C	TOL
2	5.00	10.20	12.30	
3	10.00	15.20	17.30	
4	15.00	20.20	22.30	
5	20.00	25.20	27.30	
6	25.00	30.20	32.30	+/-0.30
7	30.00	35.20	37.30	
8	35.00	40.20	42.30	
9	40.00	45.20	47.30	
10	45.00	50.20	52.30	
11	50.00	55.20	57.30	
12	55.00	60.20	62.30	

### RECOMMENDED PCB LAYOUT

P.C.B. POLARISATION OPTION 'A'

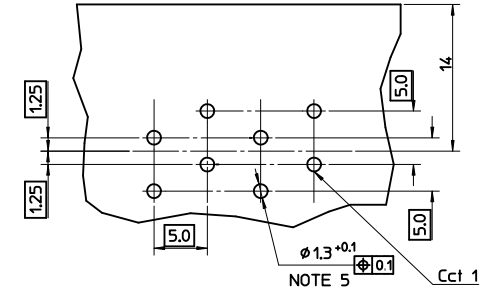

P.C.B. POLARISATION OPTION 'B'  
(FOR REVERSE FOOTPRINT)

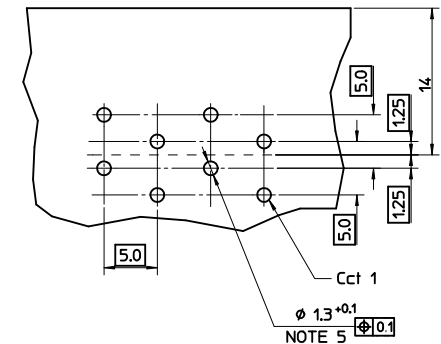

#### NOTES:

- MATERIAL:  
HOUSING: 30% GLASS-FILLED PBT, UL94 V-0  
TERMINAL: BRASS 0.80 REF. THICK  
PLATING: OPTIONAL (SEE CHARTS SHEETS 2-7)  
54µm TIN OVER  
2.54µm NICKEL ALLOVER  
SELECTIVE SILVER  
21µm SILVER OVER  
2.54µm NICKEL ALLOVER
- PRODUCT CONFORMS TO SPECIFICATION PS-99020-0037
- MATES WITH MOLEX 91338, 90833, 90835, 91777, 91778 & 91779
- PARTS PACKAGED LOOSE IN PLASTIC BAGS
- PLATED THRU HOLE
- RECOMMENDED PCB THICKNESS: 1.4±0.1mm.
- PCB VIEW IS FROM SOLDER SIDE

REV	DESCRIPTION	QUALITY SYMBOLS		GENERAL TOLERANCES (UNLESS SPECIFIED)		DIMENSION STYLE		SCALE	DESIGN UNITS	THIRD ANGLE PROJECTION
		mm	INCH	mm	INCH	MM ONLY	1:1	METRIC		
		▽=0		±	±	DRAWN BY	DATE	TITLE		
		▽=0		±0.1	±	NMCNAMAR	2004/05/22	RAST 5 R.A. HDR		
				±0.2	±	CHECKED BY	DATE			
				ANGULAR ± 2°		JDENNEHY	2004/05/23			
						APPROVED BY	DATE			
						BMAGUIRE	2004/05/27			
						MATERIAL NO.				
						SEE SHEETS 2 TO 7				
						DRAFT WHERE APPLICABLE MUST REMAIN WITHIN DIMENSIONS				
						SIZE A2				
						THIS DRAWING CONTAINS INFORMATION THAT IS PROPRIETARY TO MOLEX INCORPORATED AND SHOULD NOT BE USED WITHOUT WRITTEN PERMISSION				

# 2 CIRCUIT

SEE CODE DESIGNATION TABLE FOR NUMBERING  
FORMAT WHEN ADDING NEW PART NUMBERS

P.C.B.  
POLARISATION  
OPTION

PART NO. (TIN)	COLOUR	UNBLOCKED POSITION KEYS	UNBLOCKED CODING KEYS	LATCH POSITION	CONFIGURATION (SEE NOTES)	REF	PART NO. (SILVER)	P.C.B. POLARISATION OPTION
90879-0003	NATURAL	1b 2a	01c d20	1/2		K01	90879-0499	A
90879-0046	NATURAL	1a 2b	01c	1/2		K02	90879-0498	A
90879-0026	NATURAL	1b 2b	01c	1/2		K09	90879-0488	A
90879-0018	NATURAL	2a	01c, d20	1/2		K03	90879-0495	A
90879-0021	NATURAL	1b	01c, d20	1/2		K16	90879-0492	A
90879-0022	NATURAL	1a 2b	NONE	1/2		K06	90879-0491	A
90879-0019	NATURAL	1a 2b	d20	1/2		K05	90879-0478	A
90879-0058	NATURAL	2b	NONE	1/2		K11	90879-0476	A
90879-0029	NATURAL	1a 1b	d20	1/2		K13	90879-0486	A
90879-0030	NATURAL	2a 2b	NONE	1/2		K31	90879-0485	A
90879-0059	NATURAL	2b	d20	1/2		K38	90879-0475	A
90879-0060	NATURAL	1a 2a	01c d20	1/2		K44	90879-0474	A
90879-0061	NATURAL	1a 1b	NONE	1/2		K40	90879-0473	A
90879-0020	NATURAL	1a 1b	01c	1/2		K04	90879-0493	A
90879-0062	NATURAL	2b	01c d20	1/2		K15	90879-0472	A
90879-0057	NATURAL	1a	01c d20	1/2		K12	90879-0477	A
90879-0009	NATURAL	1a 2a	01c	1/2		K10	90879-0496	A
90879-0049	NATURAL	ALL	d20	1/2		K34	90879-0481	A
90879-0056	NATURAL	1b 2a 2b	d20	1/2		K07	90879-0479	A
90879-0063	NATURAL	1b 2a	01c d20	1/2		K01	90879-0471	B
90879-0064	NATURAL	2a	01c	1/2		k42	90879-0470	A

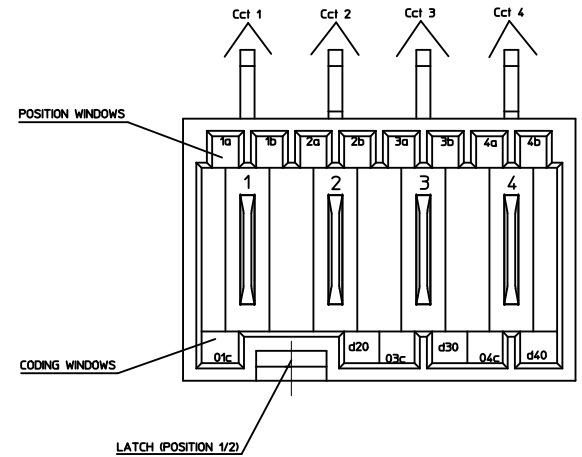

KEYING, CODING & LATCH POSITION  
(4CCT EXAMPLE SHOWN)  
VIEW INMATING DIRECTION

SEE SHEET 1	QUALITY SYMBOLS	GENERAL TOLERANCES (UNLESS SPECIFIED)	SCALE 1:1	DESIGN UNITS METRIC	THIRD ANGLE PROJECTION	REVISE ON CAD ONLY										
	 	<table border="1"> <tr><th colspan="2">DIMENSION STYLE</th></tr> <tr><td>4 PLACES</td><td>± --- ± ---</td></tr> <tr><td>3 PLACES</td><td>± --- ± ---</td></tr> <tr><td>2 PLACES</td><td>± 0.1 ± ---</td></tr> <tr><td>1 PLACE</td><td>± 0.2 ± ---</td></tr> </table>	DIMENSION STYLE		4 PLACES	± --- ± ---	3 PLACES	± --- ± ---	2 PLACES	± 0.1 ± ---	1 PLACE	± 0.2 ± ---	MM ONLY		TITLE	
		DIMENSION STYLE														
	4 PLACES	± --- ± ---														
3 PLACES	± --- ± ---															
2 PLACES	± 0.1 ± ---															
1 PLACE	± 0.2 ± ---															
DRAFT WHERE APPLICABLE MUST REMAIN WITHIN DIMENSIONS		APPROVED BY: BMAGUIRE 2004/05/27		DATE: 2004/05/27												
EC NO: DRWNBRTTLE 2010/02/24 CHKD: JDENNEY2004/05/23 APPR: BMAGUIRE 2010/06/08		APPROVED BY: JDENNEY 2004/05/23 DATE: 2004/05/23		MATERIAL NO. SEE CHART DOCUMENT NO. SD-90879-001		SHEET NO. 2 OF 5										
MOLEX INCORPORATED				THIS DRAWING CONTAINS INFORMATION THAT IS PROPRIETARY TO MOLEX INCORPORATED AND SHOULD NOT BE USED WITHOUT WRITTEN PERMISSION		A1										

3 CIRCUIT		SEE CODE DESIGNATION TABLE FOR NUMBERING FORMAT WHEN ADDING NEW PART NUMBERS						P.C.B. POLARISATION OPTION
PART NO. (TIN)	COLOUR	UNBLOCKED POSITION KEYS	UNBLOCKED CODING KEYS	LATCH POSITION	CONFIGURATION (SEE NOTES)	REF	PART NO. (SILVER)	
90879-0502	NATURAL	1b	01c, d20	1/2		K01	90879-1249	A
90879-0508	NATURAL	1a	03c	1/2		K04	90879-1248	A
90879-0528	NATURAL	1a 1b	d30	1/2		K05	90879-1247	A
90879-0512	NATURAL	1a 3b	01c	1/2		K06	90879-1246	A
90879-0513	NATURAL	1b	d20 03c	1/2		K09	90879-1245	A
90879-0529	NATURAL	1b 2a 2b	d30	1/2		K33	90879-1244	A
90879-0530	NATURAL	2b	d20	1/2		K56	90879-1243	A
90879-0526	NATURAL	ALL	d10 d30	2/3		K38	90879-1242	A
90879-0527	NATURAL	ALL	d20	1/2		K40	90879-1241	A
90879-0531	NATURAL	2b, 3a	d10, d30	2/3		K---	90879-1240	A
90879-0532	NATURAL	2b, 3b	d10, 02c	2/3		K---	90879-1239	A
90879-0533	NATURAL	1b	01c, d20	1/2		K01	90879-1238	B
90879-0534	NATURAL	1b, 2a, 2b, 3b,	NONE	2/3		K---	90879-1237	B

4 CIRCUIT		SEE CODE DESIGNATION TABLE FOR NUMBERING FORMAT WHEN ADDING NEW PART NUMBERS						P.C.B. POLARISATION OPTION
PART NO. (TIN)	COLOUR	UNBLOCKED POSITION KEYS	UNBLOCKED CODING KEYS	LATCH POSITION	CONFIGURATION (SEE NOTES)	REF	PART NO. (SILVER)	
90879-1254	NATURAL	1b	03c d40	1/2 3/4		K01	90879-1999	A
90879-1264	NATURAL	1a 4b	d40	1/2 3/4		K03	90879-1997	A
90879-1265	NATURAL	2a 4b	d20	1/2 3/4		K07	90879-1996	A
90879-1267	NATURAL	1b 2a 3a 4b	01c d40	1/2 3/4		K37	90879-1994	A
90879-1278	NATURAL	1a 2b 4b	01c 03c d40	1/2 3/4		K44	90879-1988	A
90879-1279	NATURAL	1a 3a 3b	01c d20 d40	1/2 3/4		K32	90879-1987	A
90879-1280	NATURAL	1b 2a 4b	01c d20 03c	1/2 3/4		K61	90879-1986	A
90879-1281	NATURAL	1a 3a	d40	1/2 3/4		K06	90879-1985	A
90879-1282	NATURAL	1a 2b 3b 4a	01c 03c d40	1/2 3/4		K65	90879-1984	A
90879-1266	NATURAL	2a 4b	d20 03c	1/2 3/4		K30	90879-1995	A
90879-1276	NATURAL	3b	d30	2/3		K04	90879-1989	A
90879-1283	NATURAL	1b, 2a, 3a, 4b	d20, d40	1/2, 3/4		K109	90879-1983	A
90879-1284	NATURAL	ALL	ALL	1/2, 3/4		---	90879-1982	A

SEE SHEET 1 EC NO: DRWINBRUTTLE 2010/02/24 CHKD: JDENNEHY2004/05/23 APPR: BMAGUIRE 2010/06/08 REV	QUALITY SYMBOLS	GENERAL TOLERANCES (UNLESS SPECIFIED)	SCALE 1:1	DESIGN UNITS METRIC	THIRD ANGLE PROJECTION	REVISE ON CAD ONLY
	0 0	mm	INCH	DIMENSION STYLE MM ONLY		TITLE RAST 5 R.A. HDR
		4 PLACES ± --- ± --- 3 PLACES ± --- ± --- 2 PLACES ± 0.1 ± --- 1 PLACE ± 0.2 ± ---	DRAWN BY DATE NMCNAMAR 2004/05/22		CHECKED BY DATE JDENNEHY 2004/05/23	
	ANGULAR ± 2 °		APPROVED BY DATE BMAGUIRE 2004/05/27		MATERIAL NO. DOCUMENT NO. SHEET NO. SEE CHART SD-90879-001 3 OF 5	
DRAFT WHERE APPLICABLE MUST REMAIN WITHIN DIMENSIONS			THIS DRAWING CONTAINS INFORMATION THAT IS PROPRIETARY TO MOLEX INCORPORATED AND SHOULD NOT BE USED WITHOUT WRITTEN PERMISSION			

5 CIRCUIT		SEE CODE DESIGNATION TABLE FOR NUMBERING FORMAT WHEN ADDING NEW PART NUMBERS					P.C.B. POLARISATION OPTION	
PART NO. (TIN)	COLOUR	UNBLOCKED POSITION KEYS	UNBLOCKED CODING KEYS	LATCH POSITION	CONFIGURATION (SEE NOTES)	REF	PART NO. (SILVER)	
90879-2000	NATURAL	1a 5b	01c d30	1/2 2/3		K01	90879-2749	A
90879-2001	NATURAL	1a 3a	01c d30	1/2 4/5		K30	90879-2748	A
90879-2002	NATURAL	1a 5b	01c d20 03c d50	1/2 3/4		K31	90879-2747	A
90879-2003	NATURAL	1b 2a 3b 5a	01c 03c	1/2 3/4		K35	90879-2746	A
90879-2023	NATURAL	1a 2a 2b 4b 5b	01c d30 04c d50	1/2 2/3 4/5		K36	90879-2732	A
90879-2024	NATURAL	2a	01c d50	2/3 4/5		K43	90879-2731	A
90879-2025	NATURAL	2a 4b	01c d20 d40	1/2 3/4		K44	90879-2730	A
90879-2026	NATURAL	2b	d20	1/2 4/5		K02	90879-2729	A
90879-2027	NATURAL	4b 5a	01c d30 04c d50	1/2 4/5		K45	90879-2728	A
90879-2028	NATURAL	NONE	01c d40	1/2 3/4		K46	90879-2727	A
90879-2029	NATURAL	1a 4b	d30	1/2 4/5		K04	90879-2726	A
90879-2030	NATURAL	1a 5b	d20 d40	1/2 3/4		K77	90879-2725	A
90879-2005	NATURAL	1b 2b 4a	d20 d30 d50	1/2 4/5		K40	90879-2744	A
90879-2016	NATURAL	3b 4a 5b	01c d30 d50	2/3 4/5		k47	90879-2738	A
90879-2018	NATURAL	1a 4b	01c	1/2 3/4		K48	90879-2736	A
90879-2020	NATURAL	1a 5b	d30 04c	2/3		K50	90879-2734	A
90879-2021	NATURAL	1b 2a 4a	01c 04c d50	1/2 4/5		K51	90879-2733	A
90879-2022	NATURAL	2b 3b 4a	01c d20 d40	1/2 3/4		K52	90879-2735	A

6 CIRCUIT		SEE CODE DESIGNATION TABLE FOR NUMBERING FORMAT WHEN ADDING NEW PART NUMBERS					P.C.B. POLARISATION OPTION	
PART NO. (TIN)	COLOUR	UNBLOCKED POSITION KEYS	UNBLOCKED CODING KEYS	LATCH POSITION	CONFIGURATION (SEE NOTES)	REF	PART NO. (SILVER)	
90879-2753	NATURAL	1b	03c d60	1/2 4/5		K01	90879-3499	A
90879-2754	NATURAL	1a 3b 4b	01c d50 06c	1/2 4/5		K30	90879-3498	A
90879-2755	NATURAL	1a 1b 2b 3a 3b 4b	d30 04c d50	1/2 2/3 4/5		K37	90879-3497	A
90879-2756	NATURAL	1a 1b 4a 4b	d10 d50	2/3 4/5		K39	90879-3496	A
90879-2757	NATURAL	2a 4b 5a 6b	d20 03c 05c	1/2 3/4 5/6		K42	90879-3495	A
90879-2758	NATURAL	1a 2b 3a 3b 5b 6b	01c d40 d60	1/2 3/4 5/6		K43	90879-3494	A
90879-2759	NATURAL	1b 2a 3a 4b 5a 5b 6b	01c 03c d60	1/2 3/4 5/6		K44	90879-3493	A
90879-2760	NATURAL	2b	d20 d60	1/2 5/6		K46	90879-3492	A
90879-2761	NATURAL	2b 3b 4a	01c d50 06c	1/2 4/5		K36	90879-3491	A
90879-2762	NATURAL	1b 4b	d20 03c d50 06c	1/2 4/5		K58	90879-3486	A
90879-2764	NATURAL	1a 2b 3b 4a 6b	01c 03c d40 05c d60	1/2 3/4 5/6		K59	90879-3485	A
90879-2765	NATURAL	1a 2b 4a 6b	01c d40	1/2 3/4 5/6		K62	90879-3484	A
90879-2763	NATURAL	1b 2b 3b	01c 05c d60	1/2 3/4 5/6		K51	90879-3490	A
90879-2766	NATURAL	1b	d20 03c	1/2 4/5		K55	90879-3489	A
90879-2767	NATURAL	1b 2a 3a 5a 5b	01c d20 03c d40 d60	1/2 3/4 5/6		K56	90879-3488	A
90879-2771	NATURAL	1a 3a 3b 5b 6a	01c d20 240 05c d60	1/2 3/4 5/6		K60	90879-3487	A

SEE SHEET 1	EC NO: 2010/02/24	QUALITY SYMBOLS	GENERAL TOLERANCES (UNLESS SPECIFIED)	SCALE 1:1	DESIGN UNITS METRIC	THIRD ANGLE PROJECTION	REVISE ON CAD ONLY
	DRW: BRUTTLE 2010/05/23	▽ -0	mm INCH	DIMENSION STYLE MM ONLY		TITLE RAST 5 R.A. HDR	
	CHK: JDENNEHY 2004/05/23	▽ C -0	4 PLACES ± --- ± ---	DRAWN BY DATE NMCNAMAR 2004/05/22		MATERIAL NO. DOCUMENT NO. SHEET NO.	
	APPR: BMAGUIRE 2010/06/08		3 PLACES ± --- ± ---	CHECKED BY DATE JDENNEHY 2004/05/23		SEE CHART SD-90879-001 4 OF 5	
			2 PLACES ± 0.1 ± ---	APPROVED BY DATE BMAGUIRE 2004/05/27		THIS DRAWING CONTAINS INFORMATION THAT IS PROPRIETARY TO MOLEX INCORPORATED AND SHOULD NOT BE USED WITHOUT WRITTEN PERMISSION	
			1 PLACE ± 0.2 ± ---			A1	
			ANGULAR ± 2 °				
			DRAFT WHERE APPLICABLE MUST REMAIN WITHIN DIMENSIONS				

7 CIRCUIT		SEE CODE DESIGNATION TABLE FOR NUMBERING FORMAT WHEN ADDING NEW PART NUMBERS					P.C.B. POLARISATION OPTION	
PART NO. (TIN)	COLOUR	UNBLOCKED POSITION KEYS	UNBLOCKED CODING KEYS	LATCH POSITION	CONFIGURATION (SEE NOTES)	REF	PART NO. (SILVER)	
90879-3500	NATURAL	NONE	03c d40 07c	1/2 5/6		K01	90879-4220	A
90879-3512	NATURAL	3a 4a	d30 d70	1/2 5/6		K30	90879-4248	A
90879-3504	NATURAL	2b	d20 d60	1/2 5/6		K32	90879-4247	A
90879-3513	NATURAL	1a 1b 3a 4b 5a	01c 07c	1/2 3/4 5/6		K40	90879-4240	A
90879-3514	NATURAL	2a	01c d50	2/3 4/5		K41	90879-4239	A
90879-3515	NATURAL	7b	01c d40 d70	1/2 3/4 6/7		K43	90879-4238	A
90879-3516	NATURAL	1b	03c d60	1/2 4/5		K31	90879-4237	A
90879-3517	NATURAL	1a 3a 4b 7b	01c d20 03c 06c	1/2 3/4 6/7		K45	90879-4236	A
90879-3518	NATURAL	1b 7a	02c d50	2/3 6/7		K48	90879-4235	A
90879-3519	NATURAL	1a 2b 3a 4b 6a	d20 03c d40 d50 d70	1/2 3/4 6/7		K51	90879-4234	A
90879-3520	NATURAL	1b 6a	d20 03c d50 d70	1/2 3/4 6/7		K69	90879-4233	A
90879-3505	NATURAL	1b 2a 5a 5b 7b	d20 d50 06c d70	1/2 4/5 6/7		K34	90879-4246	A
90879-3506	NATURAL	2b	d20 07c	1/2 3/4 5/6		K35	90879-4245	A
90879-3507	NATURAL	2a 2b 4b 5b 6a	d20 03c d40 d60	1/2 3/4 5/6		K38	90879-4244	A
90879-3510	NATURAL	2b 4a 4b 5b 6a	01c d20 d40 d60	1/2 3/4 5/6		K42	90879-4241	A

SEE SHEET 1 EC NO: DRW:BRUTTLE 2010/02/24 CHKD: JDENNEHY2004/05/23 APPR: BMAGUIRE 2010/06/08	QUALITY SYMBOLS	GENERAL TOLERANCES (UNLESS SPECIFIED)	SCALE 1:1	DESIGN UNITS METRIC	THIRD ANGLE PROJECTION	REVISE ON CAD ONLY
	 	mm INCH	DIMENSION STYLE MM ONLY	TITLE RAST 5 R.A. HDR		
		4 PLACES ± --- ± --- 3 PLACES ± --- ± --- 2 PLACES ± 0.1 ± --- 1 PLACE ± 0.2 ± ---	DRAWN BY DATE NMCNAMAR 2004/05/22 CHECKED BY DATE JDENNEHY 2004/05/23	MATERIAL NO. DOCUMENT NO. SHEET NO. SEE CHART SD-90879-001 5 OF 5		
		ANGULAR ± 2 °	DRAFT WHERE APPLICABLE MUST REMAIN WITHIN DIMENSIONS	APPROVED BY DATE BMAGUIRE 2004/05/27	THIS DRAWING CONTAINS INFORMATION THAT IS PROPRIETARY TO MOLEX INCORPORATED AND SHOULD NOT BE USED WITHOUT WRITTEN PERMISSION	