

AMMP-6441

36 - 40 GHz, 0.4W Power Amplifier in SMT Package



Data Sheet



Description

The AMMP-6441 MMIC is a 0.4W power amplifier in a surface mount package designed for use in transmitters that operate at frequencies between 36GHz and 40GHz. In the operational band, it provides 26 dBm of output power (P-1dB) and 20dB of small-signal gain.

Applications

- LMDS & Pt-Pt mmW Long Haul
- Microwave Radio systems
- WLL and MMDS loops

Package Diagram

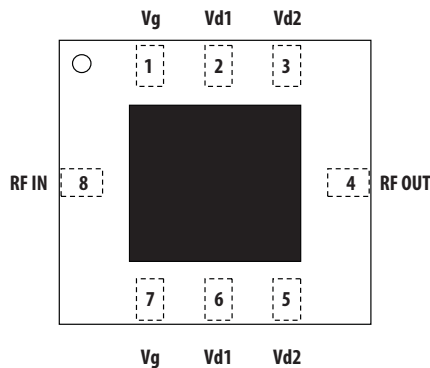

Note:

1. This MMIC uses depletion mode pHEMT devices. Negative supply is used for DC gate biasing.

Features

- 5x5mm SMT package
- 0.4 watt output power
- 50 Ω match on input and output

Typical Performance (Vd=5V, Idsq=0.45A)

- Frequency range 36 to 40 GHz
- Small signal Gain of 20dB
- Output power @P-1 of 26dBm (Typ.)
- Input and Output return losses -10dB

Functional Block Diagram

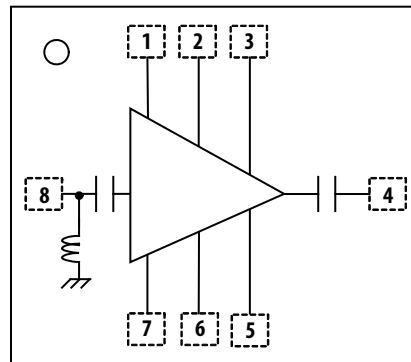

Pin	Function
1	Vg
2	Vd1
3	Vd2
4	RF OUT
5	Vd2
6	Vd1
7	Vg
8	RF IN

RoHS-Exemption



Please refer to hazardous substances table on page 10.



Attention: Observe Precautions for handling electrostatic sensitive devices.

ESD Machine Model (Class A): 40V

ESD Human Body Model (Class 0): 150V

Refer to Avago Application Note A004R:

Electrostatic Discharge Damage and Control.

Note: MSL Rating = Level 2A

Electrical Specifications

1. Small/Large -signal data measured in a fully de-embedded test fixture form TA = 25°C.
2. Pre-assembly into package performance verified 100% on-wafer per AMMC-6120 published specifications.
3. This final package part performance is verified by a functional test correlated to actual performance at one or more frequencies.
4. Specifications are derived from measurements in a 50 Ω test environment. Aspects of the amplifier performance may be improved over a more narrow bandwidth by application of additional conjugate, linearity, or low noise (Γopt) matching.

Table 1. RF Electrical Characteristics

TA=25°C, Vd=5.0V, Idq=0.45V, Vg=-1V, Zo=50 Ω

Parameter	Min	Typ.	Max	Unit
Operational Frequency, Freq	36		40	GHz
Small-signal Gain, Gain	18	20		dB
Output Power at 1dB Gain Compression, P-1dB	24.5	26		dBm
Relative Third Order Inter-modulation level (Δf=10MHz, Po=+12dBm, SCL), IM3		-38		dBc
Input Return Loss, Rlin		10		dB
Output Return Loss, Rlout		10		dB
Reverse Isolation, Isolation		45		dB

Table 2. Recommended Operating Range

1. Ambient operational temperature TA = 25°C unless otherwise noted.
2. Channel-to-backside Thermal Resistance (Tchannel (Tc) = 34°C) as measured using infrared microscopy. Thermal Resistance at backside temperature (Tb) = 25°C calculated from measured data.

Description	Min.	Typical	Max.	Unit	Comments
Drain Supply Current, Idq		450		mA	Vd = 5V, Vg set for Id Typical
Gate Supply Operating Voltage, Vg	-1.3	-1	-0.7	V	Idq=450mA

Table 3. Thermal Properties

Parameter	Test Conditions	Value
Channel Temperature, Tch		Tch=150 °C
Thermal Resistance (Channel-to-Base Plate), θch-bs	Channel-to-backside Thermal Resistance Tchannel(Tc)=34°C Thermal Resistance at backside temperature Tb=25°C	θJc = 34 °C/W

Note:

1. Assume SnPb soldering to an evaluation RF board at 85 °C base plate temperatures. Worst case is at saturated output power when DC power consumption rises to 5.24W with 0.9W RF power delivered to load. Power dissipation is 4.34W and the temperature rise in the channel is 72.9 °C. In this condition, the base plate temperature must be remained below 82.1 °C to maintain maximum operating channel temperature below 155 °C.

Absolute Minimum and Maximum Ratings

Table 4. Minimum and Maximum Ratings

Description Pin	Min.	Max.	Unit	Comments
Drain Supply Voltage, Vd		5.5	V	
Gate Supply Voltage, Vg	-2	0		
Power Dissipation, P-D		3		
CW Input Power, Pin		20	dBm	CW
Channel Temperature		+150	°C	
Storage Temperature	-65	+155	°C	
Maximum Assembly Temperature		+260	°C	30 second maximum

Notes:

1. Operation in excess of any one of these conditions may result in permanent damage to this device.

Typical Distribution Charts

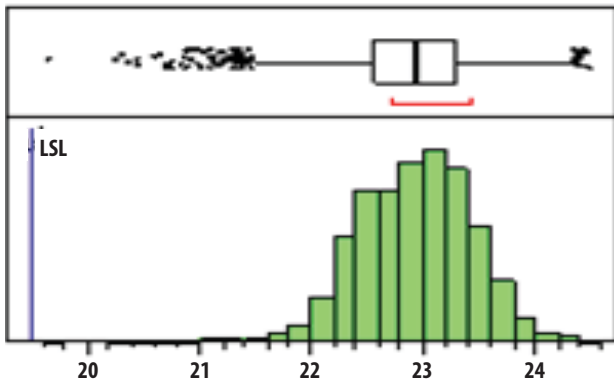

Figure A. Gain @ 37GHz, Nominal = 23, LSL = 18

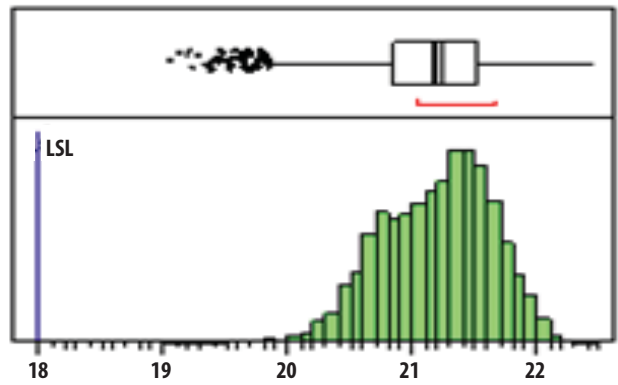

Figure B. Gain @ 38GHz, Nominal = 21, LSL = 18

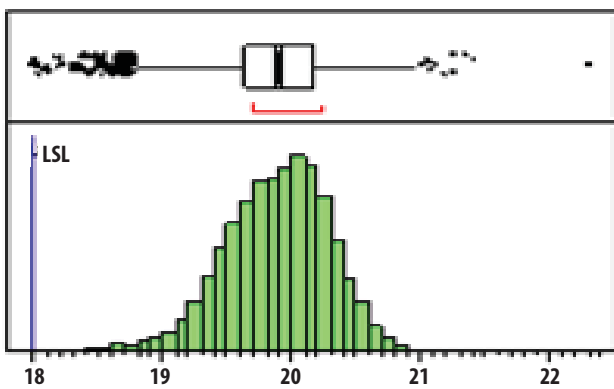

Figure C. Gain @ 40GHz, Nominal = 20, LSL = 18

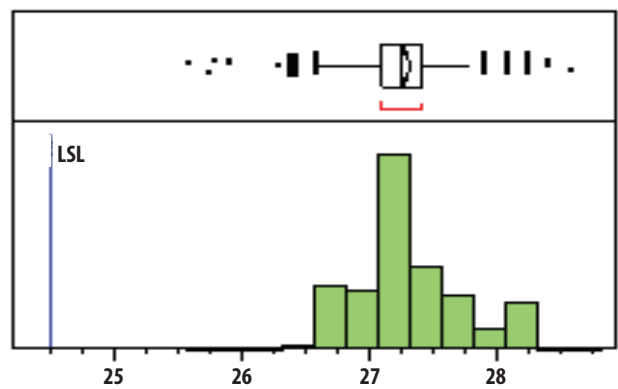

Figure D. P1dB @ 37GHz, Nominal = 27, LSL = 24.5

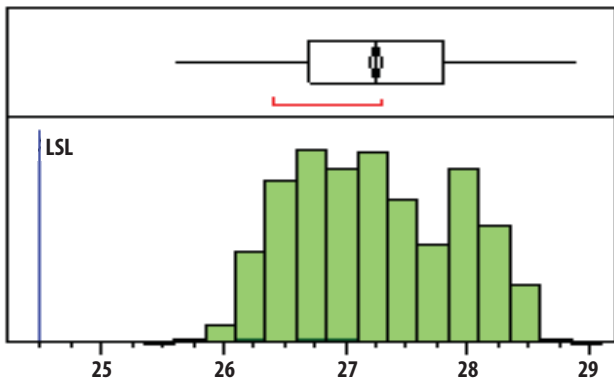

Figure E. P1dB @ 38GHz, Nominal = 27, LSL = 24.5

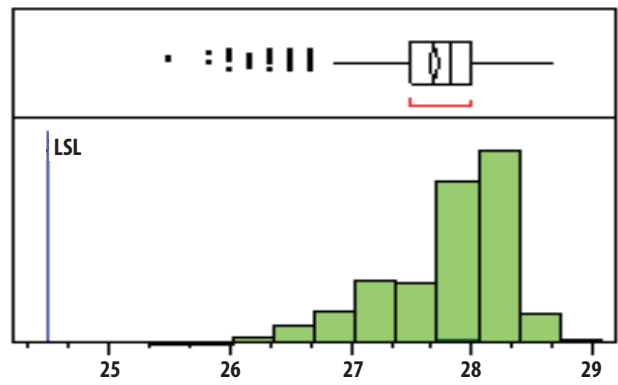

Figure F. P1dB @ 40GHz, Nominal = 28, LSL = 24.5

Typical Performance

(Data was obtained from a 2.4mm connector based test fixture and includes connector and board losses. Connector and board loss is approximately 0.5dB at input and output ports for an approximate total of 1dB.)

($T_A = 25^\circ\text{C}$, $V_{dd}=5\text{V}$, $I_{dq}=0.45\text{ A}$, $V_g=-1\text{ V}$, $Z_{in} = Z_{out} = 50\ \Omega$)

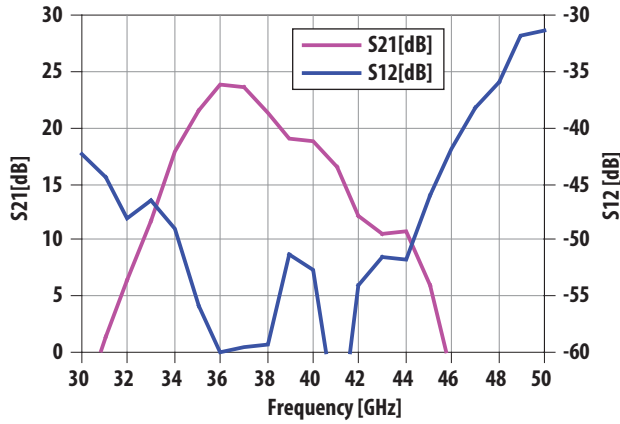

Figure 1. Typical gain and reverse Isolation

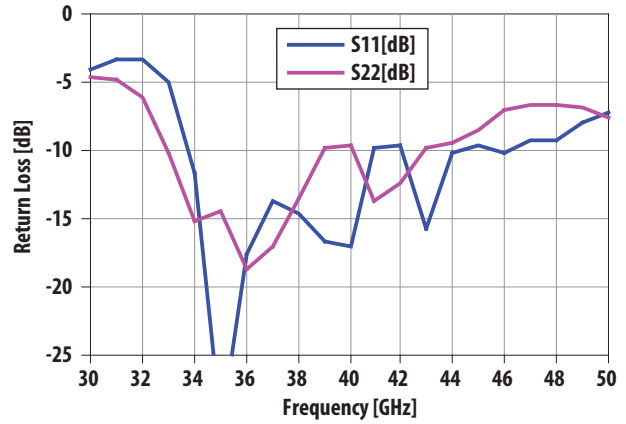

Figure 2. Typical return Loss (input and output)

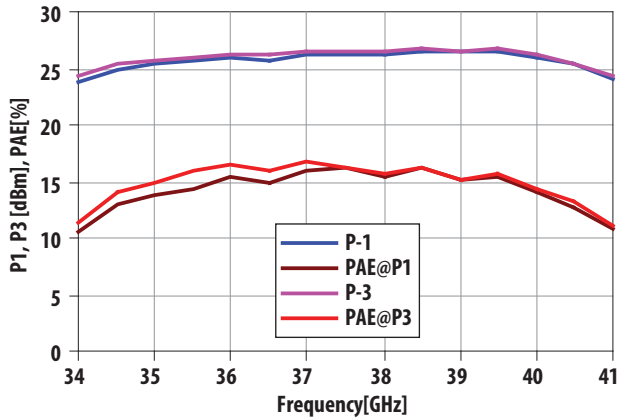

Figure 3. Typical output power (P-1 and P-3) vs. frequency

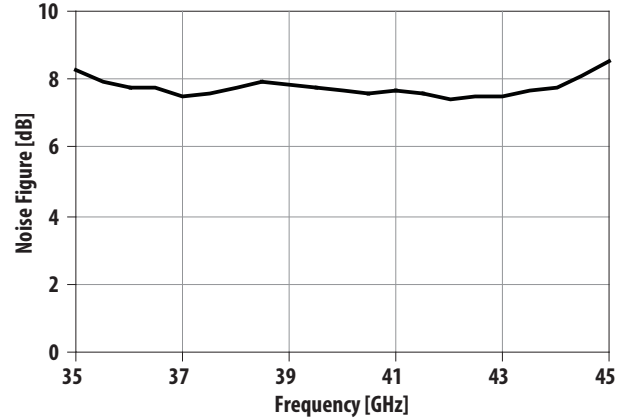

Figure 4. Typical noise figure

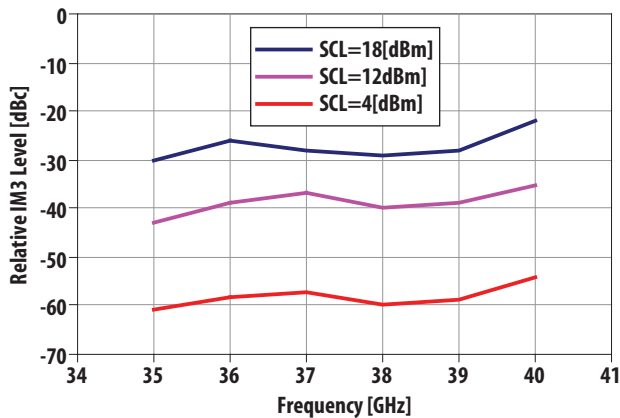

Figure 5. Typical third order inter-modulation product level vs. frequency at different single carrier output level (SCL)

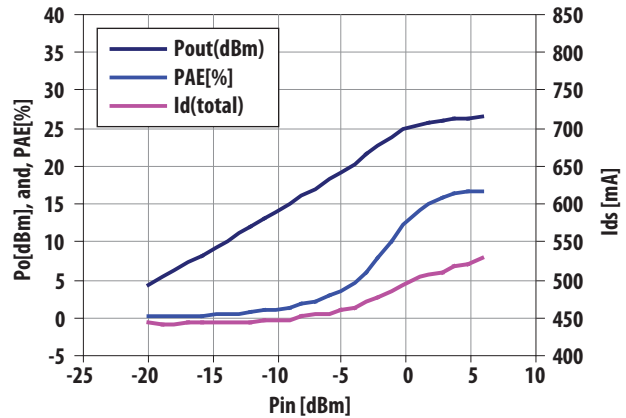

Figure 6. Typical output power, PAE, and total drain current versus Input power at 40GHz

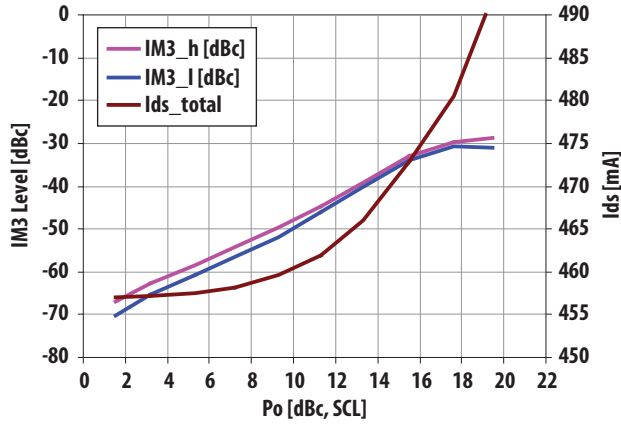

Figure 7. Typical IM3 level and Ids vs. single carrier output level at 35GHz

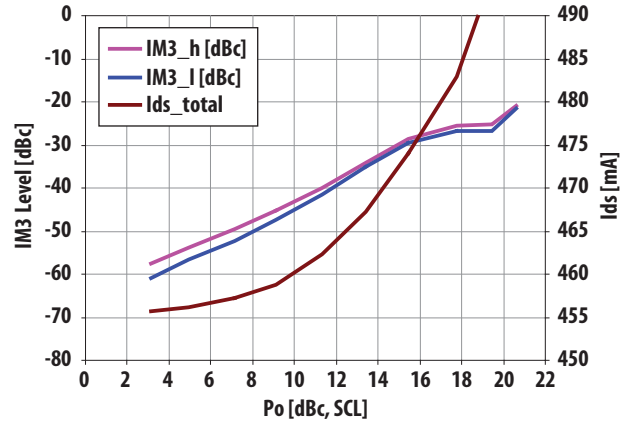

Figure 8. Typical IM3 level and Ids vs. single carrier output level at 36GHz

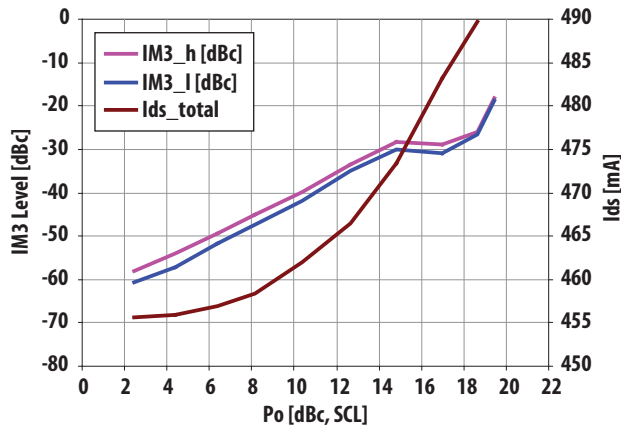

Figure 9. Typical IM3 level and Ids vs. single carrier output level at 37GHz

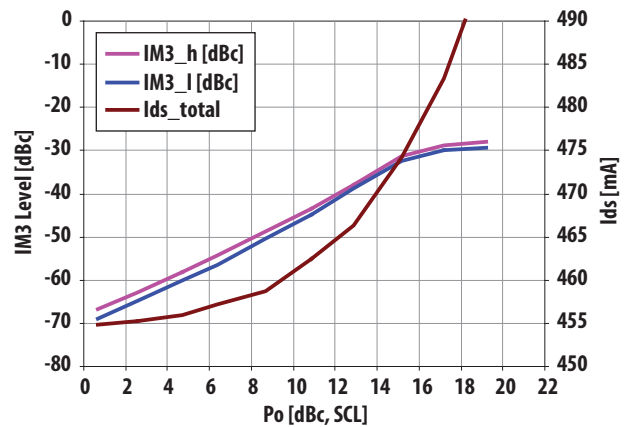

Figure 10. Typical IM3 level and Ids vs. single carrier output level at 38GHz

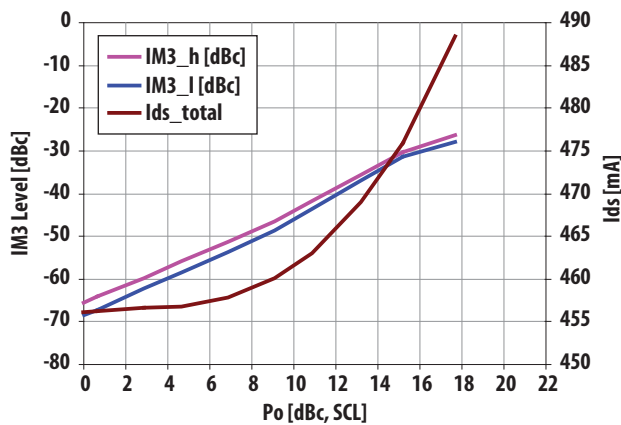

Figure 11. Typical IM3 level and Ids vs. single carrier output level at 39GHz

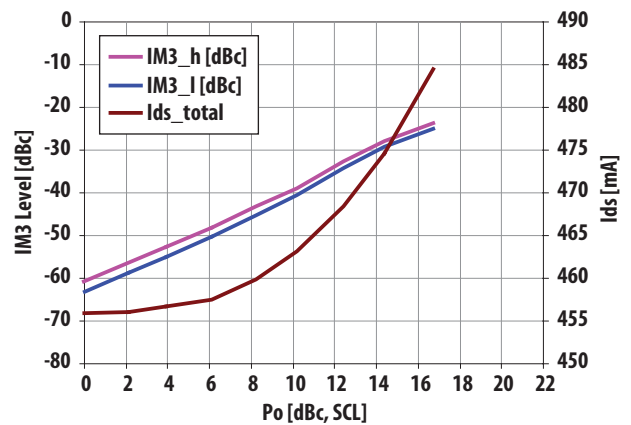

Figure 12. Typical IM3 level and Ids vs. single carrier output level at 40GHz

Typical over temperature dependencies

($V_{dd} = 5\text{ V}$, $I_{d(q)} = 0.45\text{ A}$, $Z_{in} = Z_{out} = 50\ \Omega$)

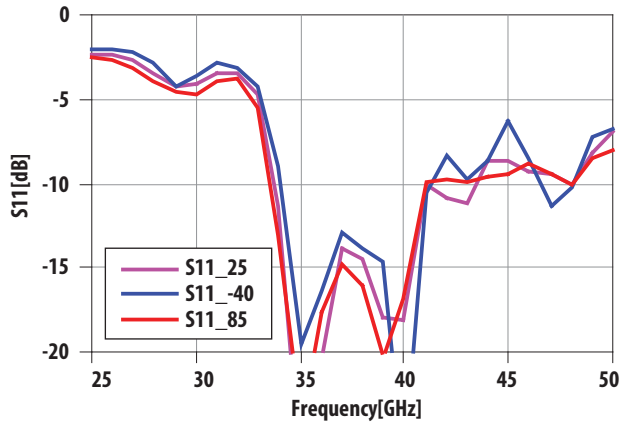

Figure 13. Typical S11 over temperature

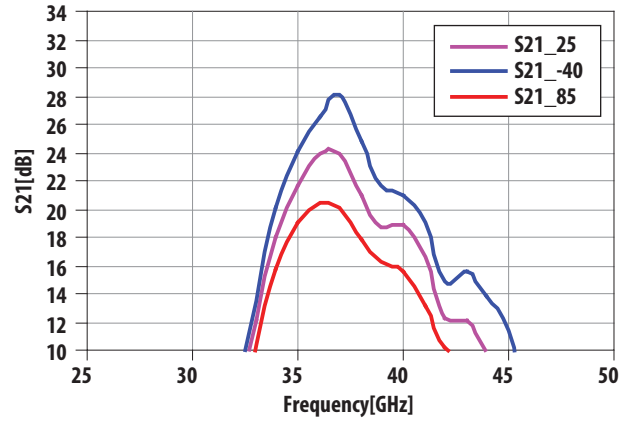

Figure 14. Typical Gain over temperature

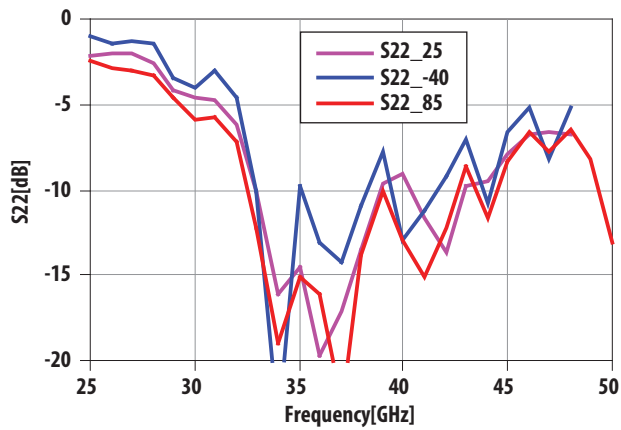

Figure 15. Typical S22 over temperature

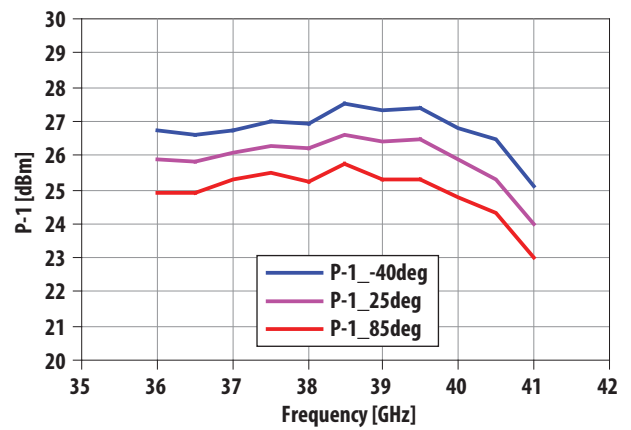

Figure 16. Typical P1 over temperature

Typical Scattering Parameters [1], ($T_A = 25^\circ\text{C}$, $V_d = 5\text{ V}$, $I_D = 0.45\text{ A}$, $Z_{in} = Z_{out} = 50\ \Omega$)

Freq	S11	S11	S11	S21	S21	S21	S12	S12	S12	S22	S22	S22
	[dB]	Mag.	Ang.	[dB]	Mag.	Ang.	[dB]	Mag.	Ang.	[dB]	Mag.	Ang.
20	-1.44	0.85	-29.26	-37.16	0.01	65.56	-63.28	6.86E-04	-177.94	-1.19	0.87	18.22
21	-1.63	0.83	-120.63	-29.23	0.03	-99.35	-54.49	1.89E-03	-40.70	-1.24	0.87	-78.33
22	-2.17	0.78	156.73	-28.37	0.04	118.06	-48.78	3.64E-03	-139.74	-1.40	0.85	-163.84
23	-2.54	0.75	82.21	-28.13	0.04	5.08	-43.64	6.58E-03	121.50	-1.70	0.82	118.20
24	-2.57	0.74	8.22	-25.49	0.05	-99.30	-46.26	4.87E-03	9.57	-2.03	0.79	42.54
25	-2.37	0.76	-72.68	-22.13	0.08	153.82	-48.56	3.73E-03	-50.55	-2.09	0.79	-37.40
26	-2.20	0.78	-157.58	-18.74	0.12	51.99	-49.99	3.17E-03	-95.33	-1.78	0.81	-125.00
27	-2.63	0.74	119.20	-15.74	0.16	-57.08	-47.44	4.24E-03	-162.87	-1.98	0.80	144.30
28	-3.60	0.66	38.52	-12.05	0.25	-151.97	-46.99	4.47E-03	129.19	-2.76	0.73	58.95
29	-4.45	0.60	-49.91	-9.02	0.35	103.37	-44.13	6.22E-03	52.66	-4.18	0.62	-26.18
30	-4.16	0.62	-146.99	-3.43	0.67	7.49	-42.45	7.54E-03	-34.31	-4.71	0.58	-119.60
31	-3.33	0.68	125.31	1.38	1.17	-104.04	-44.38	6.04E-03	-132.01	-4.83	0.57	145.56
32	-3.33	0.68	49.43	6.37	2.08	144.41	-48.04	3.96E-03	153.99	-6.19	0.49	64.25
33	-4.98	0.56	-26.60	11.65	3.83	27.95	-46.59	4.68E-03	77.28	-10.13	0.31	-4.65
34	-11.74	0.26	-113.03	17.79	7.75	-106.88	-49.08	3.51E-03	-10.06	-15.14	0.18	-19.11
35	-30.25	0.03	24.52	21.45	11.82	106.76	-55.81	1.62E-03	-98.22	-14.40	0.19	-72.40
36	-17.57	0.13	-87.74	23.79	15.47	-40.53	-60.09	9.90E-04	-129.51	-18.76	0.12	-108.00
37	-13.79	0.20	-164.97	23.65	15.22	162.26	-59.53	1.06E-03	-76.94	-17.05	0.14	132.26
38	-14.61	0.19	77.57	21.23	11.52	23.42	-59.27	1.09E-03	-175.64	-13.57	0.21	-1.64
39	-16.58	0.15	-61.70	19.06	8.98	-108.07	-51.41	2.69E-03	134.13	-9.87	0.32	-82.52
40	-17.09	0.14	-137.82	18.71	8.62	124.45	-52.74	2.31E-03	42.42	-9.66	0.33	-154.98
41	-9.75	0.33	131.82	16.44	6.64	-23.69	-67.37	4.28E-04	-5.49	-13.64	0.21	144.48
42	-9.63	0.33	43.60	12.18	4.07	-148.68	-54.05	1.98E-03	-18.28	-12.48	0.24	130.71
43	-15.69	0.16	-22.56	10.60	3.39	91.90	-51.44	2.68E-03	-84.16	-9.78	0.32	63.32
44	-10.14	0.31	-72.86	10.82	3.47	-51.05	-51.69	2.60E-03	-171.27	-9.37	0.34	-28.63
45	-9.64	0.33	-173.38	6.05	2.01	143.60	-46.06	4.98E-03	101.90	-8.56	0.37	-145.17
46	-10.16	0.31	117.40	-2.18	0.78	-7.04	-41.86	8.08E-03	-1.64	-7.06	0.44	107.01
47	-9.25	0.34	39.30	-12.11	0.25	-134.88	-38.15	1.24E-02	-106.69	-6.70	0.46	14.48
48	-9.23	0.35	-51.59	-20.73	0.09	124.23	-35.98	1.59E-02	164.73	-6.62	0.47	-69.34
49	-7.92	0.40	-143.04	-26.43	0.05	41.29	-31.88	2.55E-02	81.22	-6.92	0.45	-152.30
50	-7.21	0.44	132.95	-28.47	0.04	-47.16	-31.37	2.70E-02	-21.85	-7.65	0.41	127.63

Note:

1. Data obtained from 2.4-mm connector based modules, and this data is including connector loss, and board loss. The measurement reference plane is at the RF connectors.

Biasing and Operation.

Recommended quiescent DC bias condition for optimum power and linearity performances is $V_d=5$ volts with V_g (-1V) set for $I_d=450$ mA. Minor improvements in performance are possible depending on the application. The drain bias voltage range is 3 to 5V. A single DC gate supply connected to V_g will bias all gain stages. Muting can be accomplished by setting V_g to the pinch-off voltage V_p (-2V).

A typical DC biasing connection is shown in Figure 17. V_g and V_d can be biased from either side. The RF input port is connected internally to ground; therefore, an input decoupling capacitor is needed if the preceding output stage has DC present. The RF output is DC decoupled internally. No ground wires are needed since ground connections are made with plated through-holes to the backside of the device.

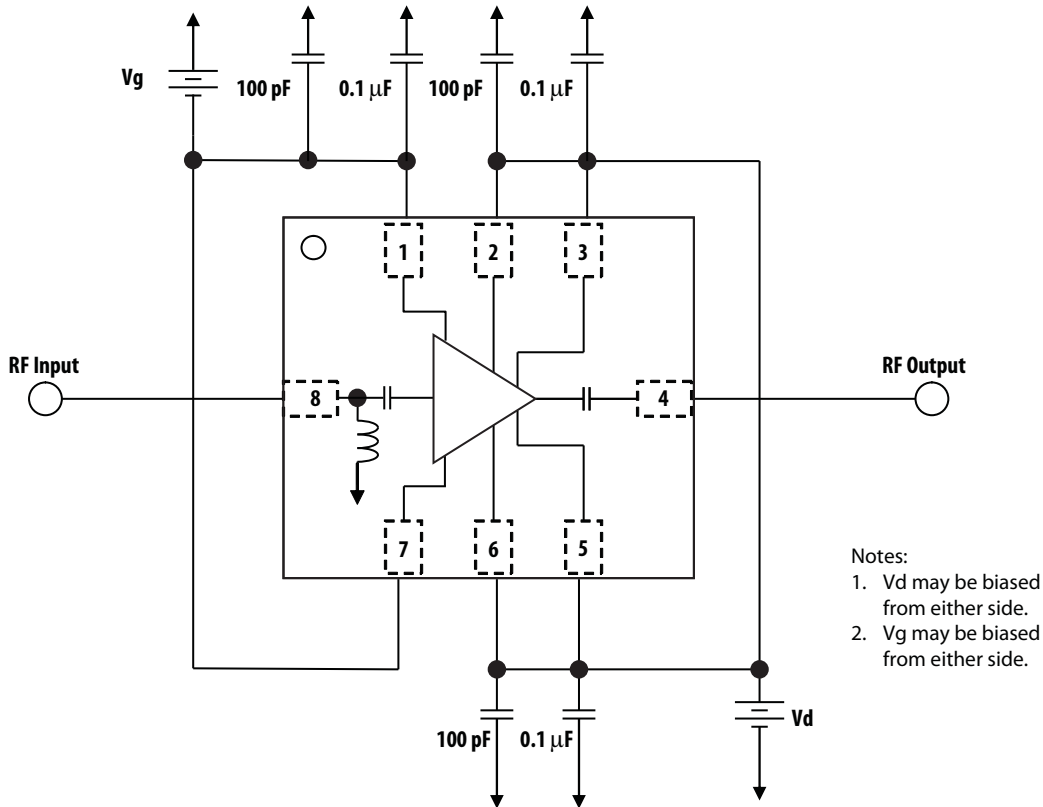

Figure 17. Schematic and recommended assemble example

Note: No RF performance degradation is seen due to ESD up to 150V HBM and 40V MM. The DC characteristics in general show increased leakage at higher ESD discharge voltages. The user is reminded that this device is ESD sensitive and needs to be handled with all necessary ESD protocols.

AMMP-64xx Part Number Ordering Information

Part Number	Devices Per Container	Container
AMMP-6441-BLKG	10	Antistatic bag
AMMP-6441-TR1G	100	7" Reel
AMMP-6441-TR2G	500	7" Reel

Package Dimension, PCB Layout and Tape and Reel information

Please refer to Avago Technologies Application Note 5520, AMxP-xxxx production Assembly Process (Land Pattern A).



Names and Contents of the Toxic and Hazardous Substances or Elements in the Products 产品中有毒有害物质或元素的名称及含量

Part Name 部件名称	Toxic and Hazardous Substances or Elements 有毒有害物质或元素					
	Lead (Pb) 铅 (Pb)	Mercury (Hg) 汞 (Hg)	Cadmium (Cd) 镉 (Cd)	Hexavalent (Cr(VI)) 六价铬 (Cr(VI))	Polybrominated biphenyl (PBB) 多溴联苯 (PBB)	Polybrominated diphenylether (PBDE) 多溴二苯醚 (PBDE)
100pF capacitor	x	o	o	o	o	o

o: indicates that the content of the toxic and hazardous substance in all the homogeneous materials of the part is below the concentration limit requirement as described in SJ/T 11363-2006.
x: indicates that the content of the toxic and hazardous substance in at least one homogeneous material of the part exceeds the concentration limit requirement as described in SJ/T 11363-2006.
(The enterprise may further explain the technical reasons for the "x" indicated portion in the table in accordance with the actual situations.)

o: 表示该有毒有害物质在该部件所有均质材料中的含量均在 SJ/T 11363-2006 标准规定的限量要求以下。
x: 表示该有毒有害物质至少在该部件的某一均质材料中的含量超出 SJ/T 11363-2006 标准规定的限量要求。
(企业可在此处, 根据实际情况对上表中打"x"的技术原因进行进一步说明。)

Note: EU RoHS compliant under exemption clause of "lead in electronic ceramic parts (e.g. piezoelectronic devices)"

For product information and a complete list of distributors, please go to our web site: www.avagotech.com

Avago, Avago Technologies, and the A logo are trademarks of Avago Technologies in the United States and other countries.
Data subject to change. Copyright © 2005-2011 Avago Technologies. All rights reserved.
AV02-1908EN - June 21, 2011

AVAGO
TECHNOLOGIES