

Features

- Wide input voltage range: 2.2V – 5.5V
- 230mV very low dropout at 500mA load
- 500mV very low dropout at 1A load
- Very low quiescent current (I_{Q}): 125 μ A typical
- Adjustable output voltage range: 0.8V to 5.0V
- Very fast transient response
- High PSRR
- Accurate voltage regulation
- Current limiting and short circuit protection
- Thermal shutdown protection
- Stable with any type output capacitor $\geq 4.7\mu$ F
- Ambient temperature range -40°C to 85°C
- DFN3030-10: Available in “Green” Molding Compound (no Br, Sb)
- Lead Free Finish/RoHS Compliant (Note 1)

Description

The AP7167 is a 1.2A, adjustable output voltage, ultra-low dropout linear regulator. The device includes pass element, error amplifier, band-gap reference, current limit and thermal shutdown circuitry. The device is turned on when EN pin is set to logic high level. A Power-OK (POK) output is available for power sequence control.

The characteristics of the low dropout voltage and low quiescent current make it suitable for low to medium power applications, for example, laptop computers, audio and video applications, and battery powered devices. The typical quiescent current is approximately 125 μ A.

Built-in current-limit and thermal-shutdown functions prevent IC from damage in fault conditions. The AP7167 is available in DFN3030-10 package.

Applications

- Servers and laptops
- Smart phone and PDA
- MP3/MP4
- Bluetooth headset
- Low and medium power applications
- FPGA and DSP core or I/O power

Ordering Information

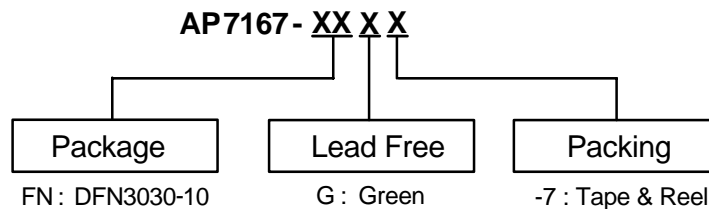

Note: 1. RoHS revision 13.2.2003. Glass and High Temperature Solder Exemptions Applied, see *EU Directive Annex Notes 5 and 7*.

Device	Package Code	Packaging (Note 2)	7" Tape and Reel	
			Quantity	Part Number Suffix
AP7167-FN	FN	DFN3030-10	3000/Tape & Reel	-7

Note: 2. Pad layout as shown on Diodes Inc. suggested pad layout document AP02001, which can be found on our website at <http://www.diodes.com/datasheets/ap02001.pdf>.

Pin Assignment

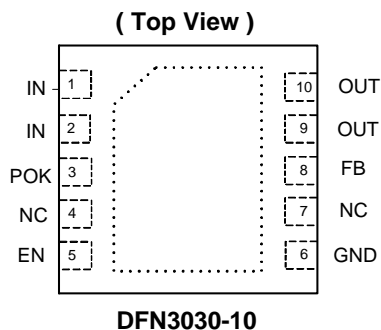

Pin Descriptions

Name	Pin No.	Description
IN	1, 2	Voltage input pins, to be tied together externally. Bypass to ground through at least 1 μ F capacitor.
POK	3	Power-OK output, active-high open-drain
EN	5	Enable input, active high
GND	6	Ground
FB	8	Output feedback
OUT	9, 10	Voltage output pins, to be tied together externally. Bypass to ground through at least 4.7 μ F ceramic capacitor
NC	4, 7	No connection

Functional Block Diagram

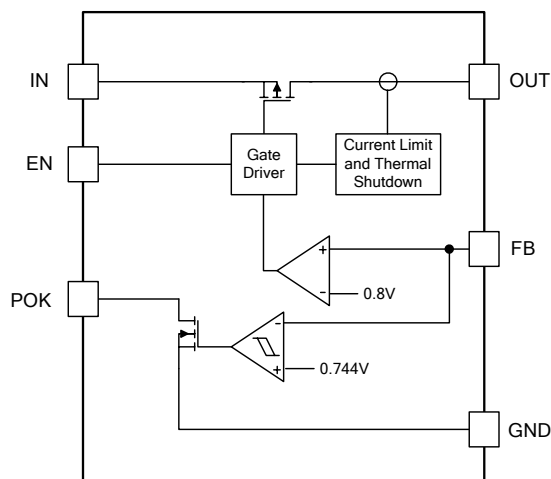

Typical Application Circuit

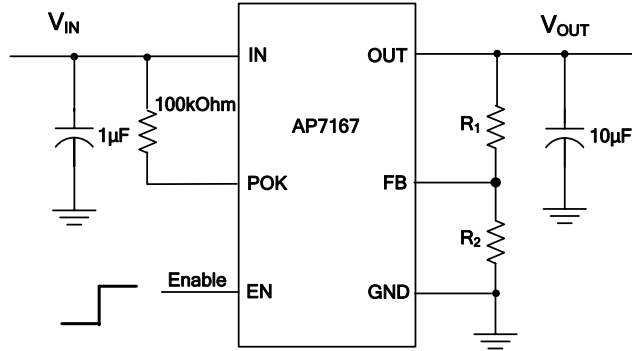

$$V_{OUT} = V_{REF} \left(1 + \frac{R_1}{R_2} \right)$$

Absolute Maximum Ratings

Symbol	Parameter	Ratings	Unit
ESD HBM	Human Body Model ESD Protection	4	KV
ESD MM	Machine Model ESD Protection	300	V
V _{IN}	Input Voltage	7	V
	OUT, FB, POK, EN Voltage	V _{IN} + 0.3	V
	Continuous Load Current	Internal Limited	
T _J	Operating Junction Temperature Range	-40 ~ 150	°C
T _{ST}	Storage Temperature Range	-65 ~ 150	°C
P _D	Power Dissipation (Note 3,5)	DFN3030-10	3.1
			W

Note: 3. Ratings apply to ambient temperature at 25°C.

Recommended Operating Conditions

Symbol	Parameter	Min	Max	Unit
V _{IN}	Input voltage	2.2	5.5	V
I _{OUT}	Output Current	0	1.2	A
T _A	Operating Ambient Temperature	-40	85	°C

Electrical Characteristics

 (T_A = 25°C, V_{IN} = V_{OUT} + 1V, C_{IN} = 1μF, C_{OUT} = 10μF, V_{EN} = V_{IN}, unless otherwise stated)

Symbol	Parameter	Test Conditions	Min	Typ.	Max	Unit
I _Q	Input Quiescent Current	I _{OUT} = 0	—	125	180	μA
I _{SHDN}	Input Shutdown Current	V _{EN} = 0V, I _{OUT} = 0 (Note 4)	-1	0.1	1	μA
V _{Dropout}	Dropout Voltage	V _{OUT} ≥ 1.5V, I _{OUT} = 0.5A		230		mV
		V _{OUT} ≥ 1.5V, I _{OUT} = 1A		500	800	mV
V _{REF}	FB reference voltage			0.8		V
I _{FB}	FB leakage		—	0.01	1	μA
V _{OUT}	Output Voltage Total Accuracy		-3		3	%
$\frac{\Delta V_{OUT}}{\Delta V_{IN}} / V_{OUT}$	Line Regulation	V _{IN} = V _{OUT} + 1V to 5.5V, I _{OUT} = 1mA		0.02		%/V
$\Delta V_{OUT} / V_{OUT}$	Load Regulation	I _{OUT} from 1mA to 1A	-1.5		1.5	%
t _{ST}	Start-up Time, from EN high to POK high	V _{EN} = 0V to 2.0V, I _{OUT} = 100mA, V _{IN} = 3.3V		190		μs
PSRR	Power Supply Rejection Ratio	1kHz, V _{IN} = 3.3V, V _{OUT} = 1.2V, I _{OUT} = 100mA		60		dB
I _{LIMIT}	Current limit	V _{OUT} = 1.8V, R _{OUT} = 0.5Ω	1.2	1.6		A
I _{SHORT}	Short-circuit Current	V _{IN} = 3.3V, V _{OUT} < 0.2V		750		mA
V _{IL}	EN Input Logic Low Voltage				0.4	V
V _{IH}	EN Input Logic High Voltage		1.4			V
I _{EN}	EN Input leakage	V _{EN} = 0V or 5.5V	—	0.01	1	μA
V _{OL}	POK output low voltage	Sink 2mA		100	200	mV
V _{POK_TH_UP}	Output voltage (rising) POK threshold	FB (or OUT for fixed version) rising	87%	92%	97%	V _{ref}
V _{POK_Hys}	Output voltage POK hysteresis			4%		V _{ref}
POK deglitch		V _{IN} = 3.3V, V _{OUT} = 1.2V		160		μs
I _{POK_LK}	POK leakage current	V _{POK} = 5.5V	—	0.01	1	μA
T _{SHDN}	Thermal shutdown threshold			155		°C
T _{HYS}	Thermal shutdown hysteresis			25		°C
θ _{JA}	Thermal Resistance Junction-to-Ambient	DFN3030-10 (Note 5)		40		°C/W

Note: 4. POK pin must be disconnected from IN pin.

5. Test condition for DFN3030-10: Device mounted on FR-4 2-layer board, 2oz copper, with minimum recommended pad on top layer and 6 vias to bottom layer 1.0"x1.5" ground plane.

Typical Performance Characteristics

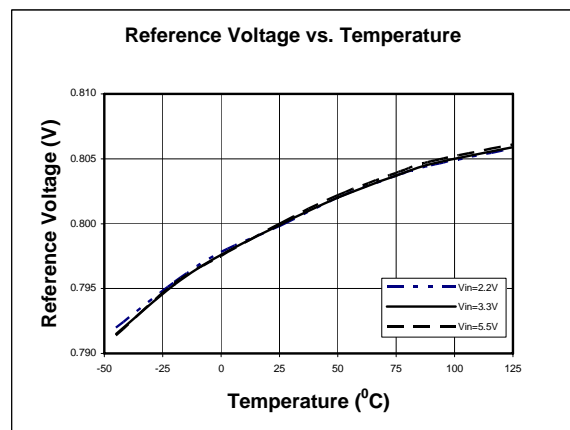
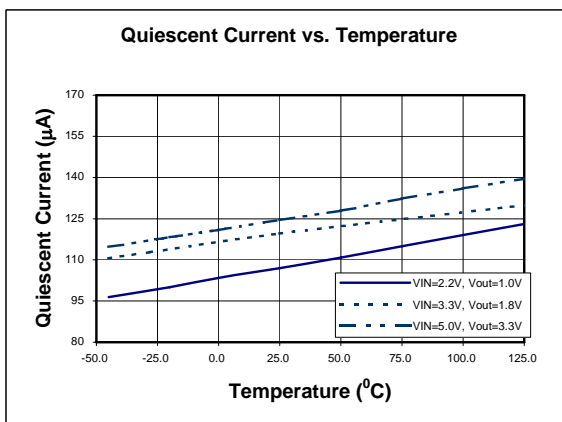
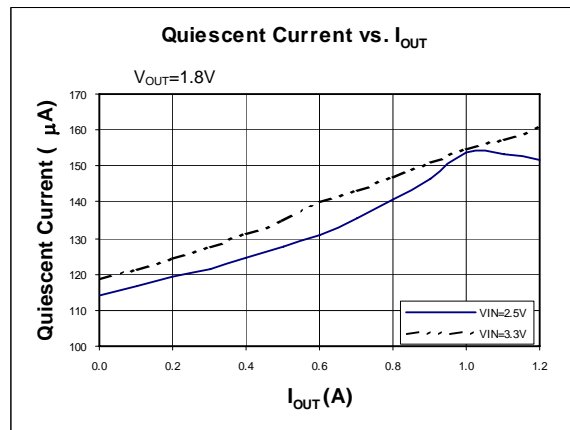
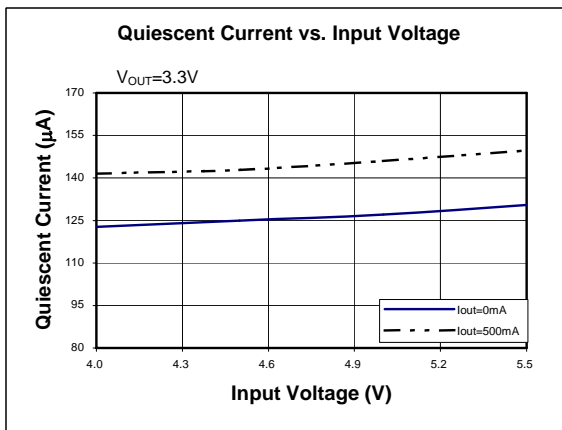
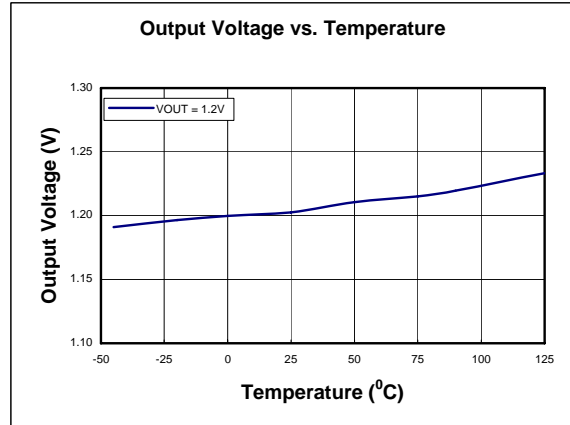
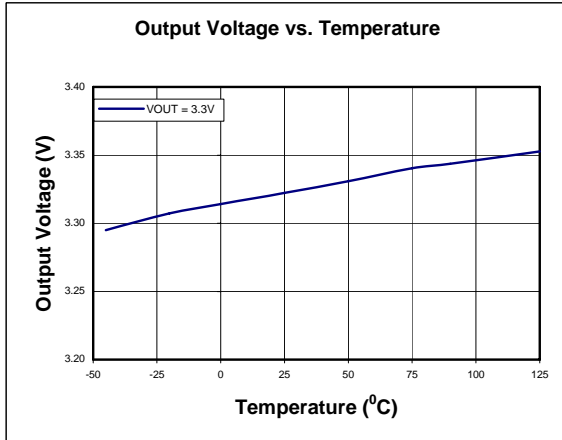

Typical Performance Characteristics (Continued)

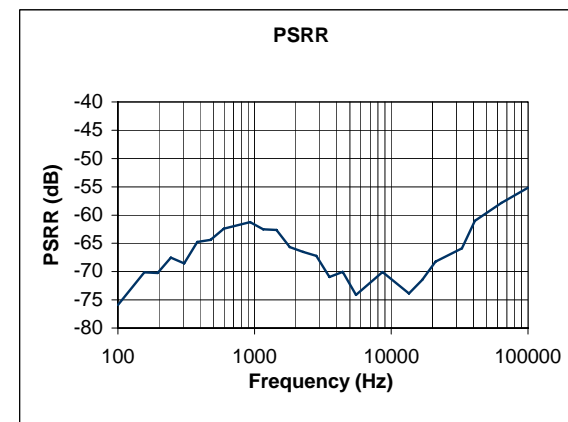
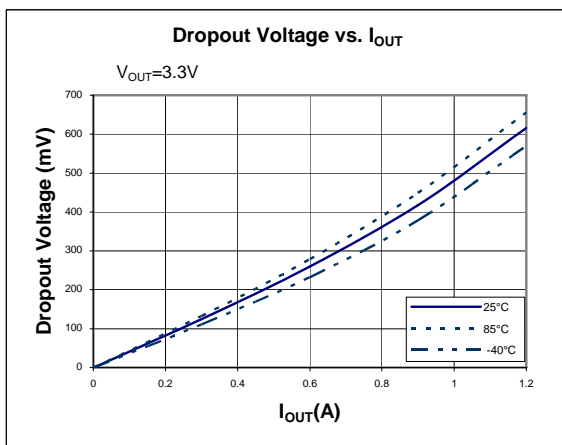
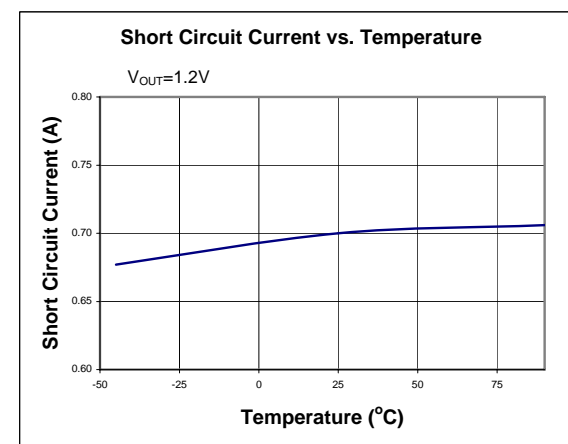
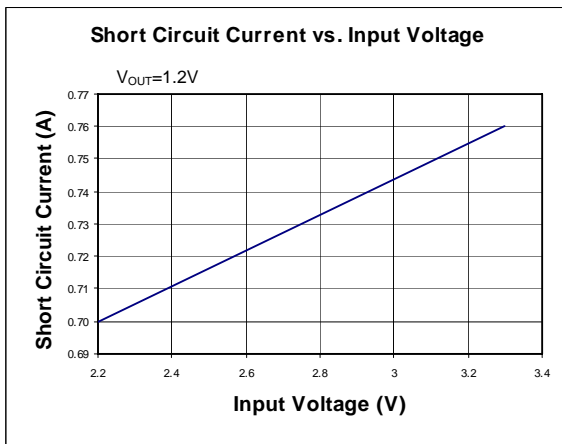
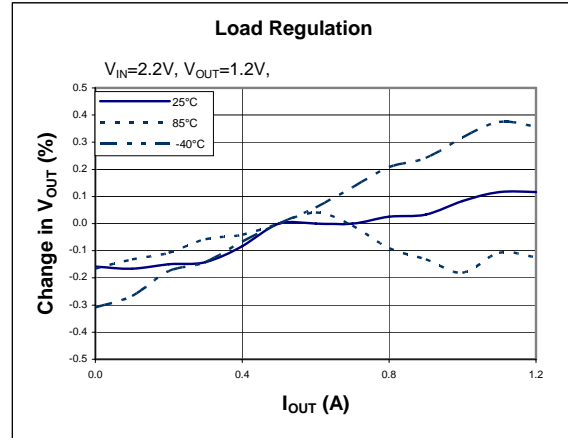
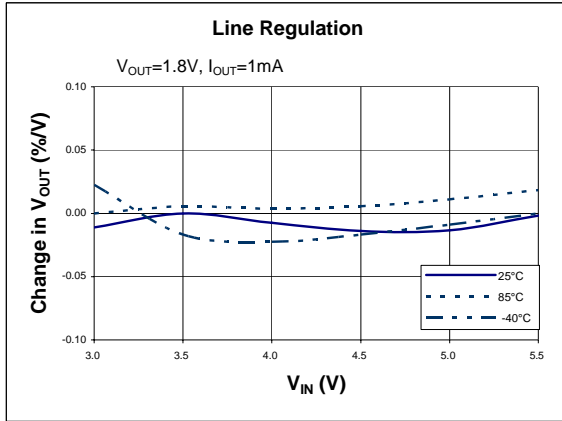

Typical Performance Characteristics (Continued)

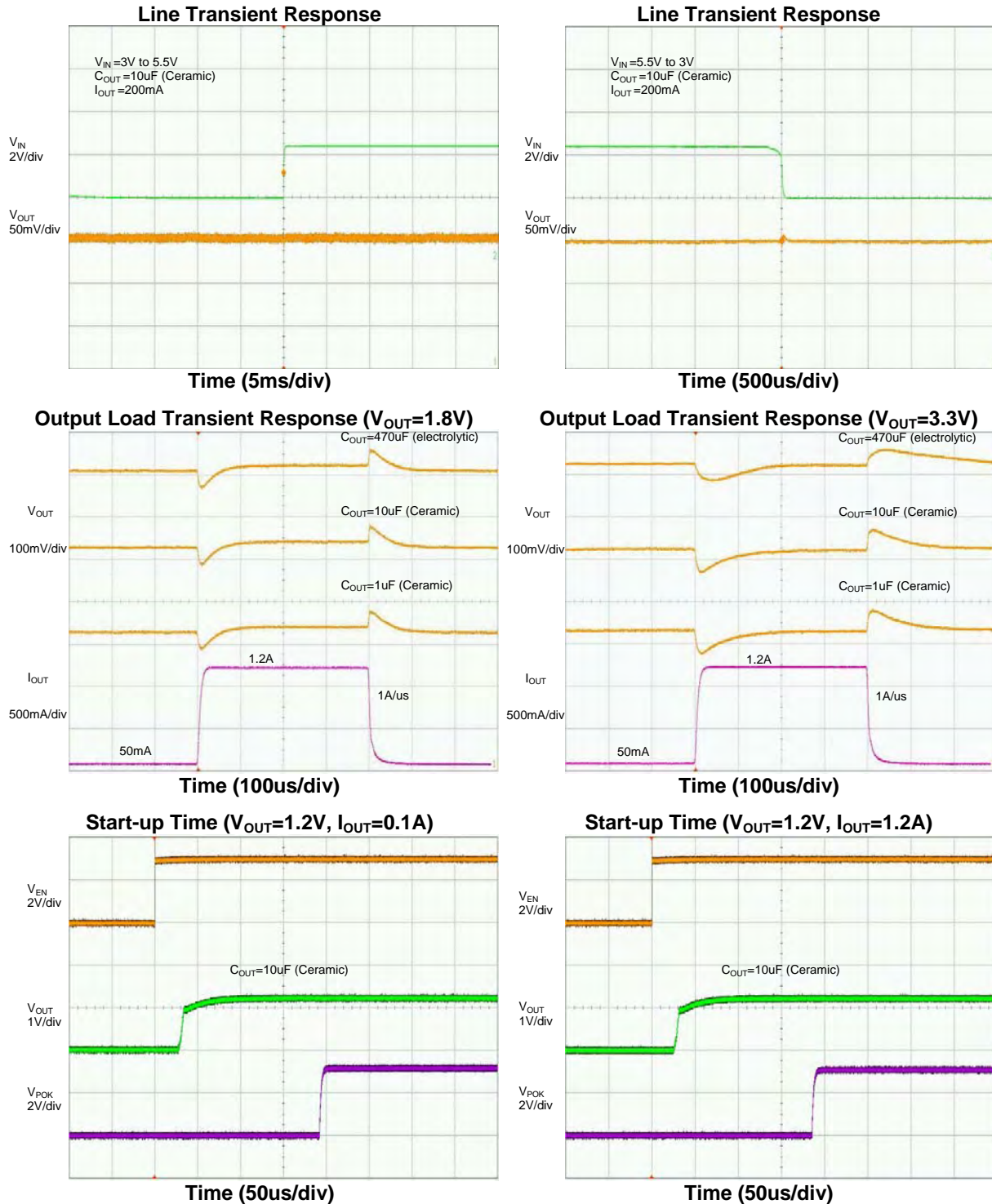

Typical Performance Characteristics (Continued)

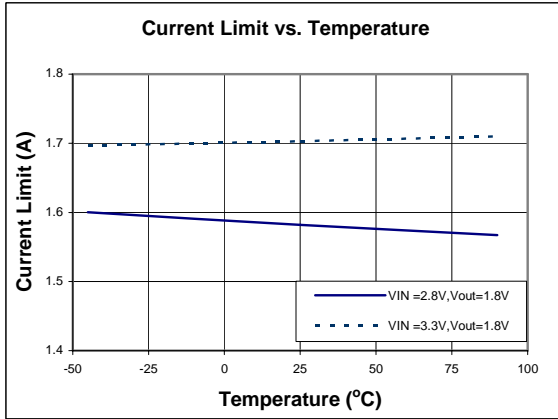

Application Note

Input Capacitor

A 1µF ceramic capacitor is recommended to connect between IN and GND pins to decouple input power supply glitch and noise. The amount of the capacitance may be increased without limit. A lower ESR (Equivalent Series Resistance) capacitor allows the use of less capacitance, while higher ESR type requires more capacitance. This input capacitor should be located as close as possible to the device to assure input stability and less noise. For PCB layout, a wide copper trace is required for both IN and GND.

Output Capacitor

The output capacitor is required to stabilize and help the transient response of the LDO. The AP7167 is designed to have excellent transient response for most applications with a small amount of output capacitance. The AP7167 is stable for all available types and values of output capacitors ≥ 4.7µF. The device is also stable with multiple capacitors in parallel, which can be of any type of value. Additional capacitance helps to reduce undershoot and overshoot during transient. This capacitor should be placed as close as possible to OUT and GND pins for optimum performance.

Adjustable Operation

The AP7167 provides output voltage from 0.8V to 5.0V through external resistor divider as shown below.

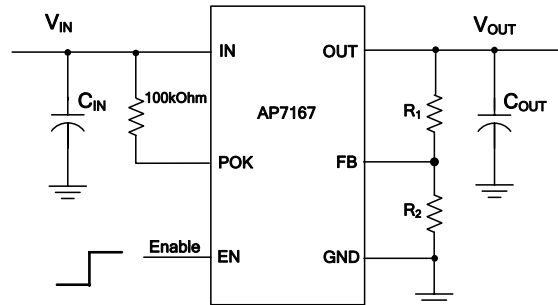

The output voltage is calculated by:

$$V_{OUT} = V_{REF} \left(1 + \frac{R_1}{R_2} \right)$$

Where $V_{REF}=0.8V$ (the internal reference voltage)

Rearranging the equation will give the following equation to find the approximate resistor divider values:

$$R_1 = R_2 \left(\frac{V_{OUT}}{V_{REF}} - 1 \right)$$

To maintain the stability of the internal reference voltage, R_2 needs to be kept smaller than 250kΩ.

Application Note (Continued)

No Load Stability

Other than external resistor divider, no minimum load is required to keep the device stable. The device will remain stable and regulated in no load condition.

ENABLE/SHUTDOWN Operation

The AP7167 is turned on by setting the EN pin high, and is turned off by pulling it low. If this feature is not used, the EN pin should be tied to IN pin to keep the regulator output on at all time. To ensure proper operation, the signal source used to drive the EN pin must be able to swing above and below the specified turn-on/off voltage thresholds listed in the Electrical Characteristics section under V_{IL} and V_{IH} .

POWER-OK

The Power-Ok (POK) pin is an active high open-drain output. It can be connected to any 5.5V or lower rail through an external pull-up resistor. The recommended sink current of POK pin is up to 4mA, so the pull-up resistor for POK should be in the range of 10k Ω to 1M Ω . If output voltage monitoring is not needed, the POK pin can be left floating.

Current Limit Protection

When output current at OUT pin is higher than current limit threshold, the current limit protection will be triggered and clamp the output current to approximately 1.6A (1.2A min) to prevent over-current and to protect the regulator from damage due to overheating.

Short Circuit Protection

When OUT pin is short-circuited to GND or OUT pin voltage is less than 200mV, short circuit protection will be triggered and clamp the output current to approximately 750mA. This feature protects the regulator from over-current and damage due to overheating.

Low Quiescent Current

The AP7167, consuming only around 150 μ A for all input range and output loading, provides great power saving in portable and low power applications.

Wide Output Range

The AP7167, with a wide output range of 0.8V to 5.0V, provides a versatile solution for many portable and low power applications.

Thermal Shutdown Protection

Thermal protection disables the output when the junction temperature rises to approximately +155 $^{\circ}$ C, allowing the device to cool down. When the junction temperature reduces to approximately +130 $^{\circ}$ C the output circuitry is enabled again. Depending on power dissipation, thermal resistance, and ambient temperature, the thermal protection circuit may cycle on and off. This cycling limits the heat dissipation of the regulator, protecting it from damage due to overheating.

Power Dissipation

The device power dissipation and proper sizing of the thermal plane that is connected to the thermal pad is critical to avoid thermal shutdown and ensuring reliable operation. Power dissipation of the device depends on input voltage and load conditions and can be calculated by:

$$P_D = (V_{IN} - V_{OUT})I_{OUT}$$

The AP7167 is available in the DFN3030-10 package with exposed pad, which is the primary conduction path for heat to the printed circuit board (PCB). The pad can be connected to ground or be left floating; however, to ensure the device will not overheat, it should be attached to an appropriate amount of copper PCB area.

However, the maximum power dissipation that can be handled by the device depends on the maximum junction to ambient thermal resistance, maximum ambient temperature, and maximum device junction temperature, which can be approximated by the equation below:

$$P_D(\text{max}@T_A) = \frac{(+150^{\circ}\text{C} - T_A)}{R_{\theta JA}}$$

Marking Information

(1) DFN3030-10

(Top View)

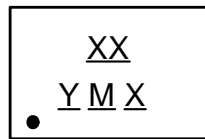

XX : B4 : AP7167

Y : Year 0~9

M : Month A~L

X : G : Green

Part Number	Package	Identification Code
AP7167	DFN3030-10	B4

Package Information (All Dimensions in mm)

(1) DFN3030-10

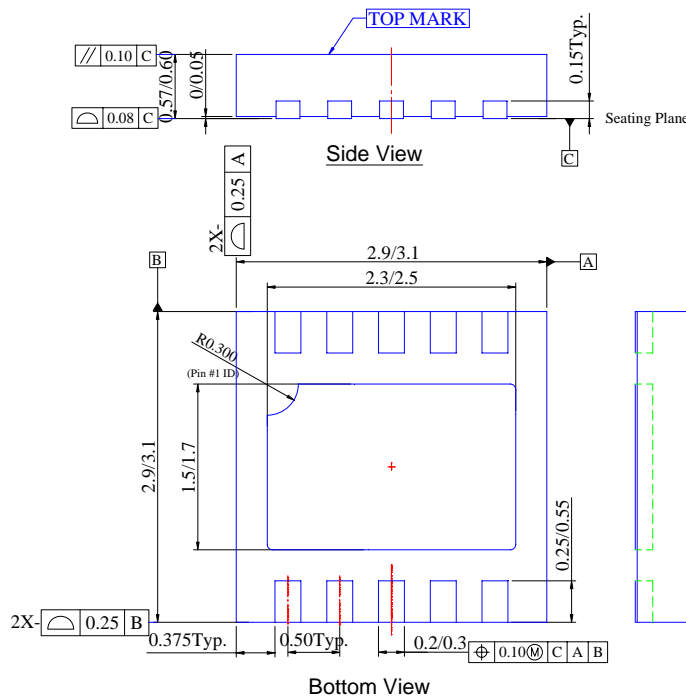

Note: 6. ALL DIMENSIONS ARE IN MILLIMETERS. ANGLES ARE IN DEGREES.
7. COPLANARITY APPLIES TO THE EXPOSED HEAT SINK SLUG AS WELL AS THE TERMINALS.

IMPORTANT NOTICE

Diodes Incorporated and its subsidiaries reserve the right to make modifications, enhancements, improvements, corrections or other changes without further notice to any product herein. Diodes Incorporated does not assume any liability arising out of the application or use of any product described herein; neither does it convey any license under its patent rights, nor the rights of others. The user of products in such applications shall assume all risks of such use and will agree to hold Diodes Incorporated and all the companies whose products are represented on our website, harmless against all damages.

LIFE SUPPORT

Diodes Incorporated products are not authorized for use as critical components in life support devices or systems without the expressed written approval of the President of Diodes Incorporated.