

# ORCY-D4T12H

## Isolated DC-DC Converter

The ORCY-D4T12H is an isolated DC/DC converter that operate from a nominal 48 VDC source. This unit provides up to 240 W of output power from a nominal 48 VDC input. This unit is designed to be highly efficient and low cost.

Features include remote on/off, short circuit protection, over current protection, under voltage lockout and over-temperature protection.

The converter is provided in an industry standard eighth brick package.

### Key Features & Benefits

- 48 VDC Input
- 12 VDC @ 20 A Output
- 1/8th Brick Converter
- Fixed Frequency (350 kHz)
- High Efficiency
- High Power Density
- Input Under Voltage Lockout
- OCP/SCP
- Output Over-voltage Protection
- Over Temperature Protection
- Remote On/Off
- Low Cost
- Basic Isolation
- Approved to UL/CSA 60950-1
- Approved to IEC/EN 60950-1
- Approved to UL/CSA 62368-1
- Approved to IEC/EN 62368-1
- Class II, Category 2, Isolated DC/DC Converter (refer to IPC-9592B)



### Applications

- Networking
- Computers and Peripherals
- Telecommunications

## 1. MODEL SELECTION

MODEL NUMBER	OUTPUT VOLTAGE	INPUT VOLTAGE	MAX. OUTPUT CURRENT	MAX. OUTPUT POWER	TYPICAL EFFICIENCY
0RCY-D4T12HG	12 VDC	48 VDC	20 A	240 W	95.5% (Half load)

### PART NUMBER EXPLANATION

0	R	CY	-	D4	T	12	H	G
Mounting Type	RoHS Status	Series Name		Output Power	Input Range	Output Voltage	Active Logic	Package Type
Through hole mount	RoHS	1/8th Brick		240 W	36 - 75 V	12 V	Active Low, Open Frame	Tray package

## 2. ABSOLUTE MAXIMUM RATINGS

PARAMETER	DESCRIPTION	MIN	TYP	MAX	UNITS
Continuous Non-operating Input Voltage		-0.3	-	80	V
Input Transient Voltage	100 ms maximum	-	-	100	V
Remote On/Off		-0.3	-	18	V
I/O Isolation Voltage		-	-	2250	V
Ambient Temperature		-40	-	85	°C
Storage Temperature		-55	-	125	°C
Altitude		-	-	2000	m

**NOTE:** Ratings used beyond the maximum ratings may cause a reliability degradation of the converter or may permanently damage the device.

### 3. INPUT SPECIFICATIONS

All specifications are typical at 25°C unless otherwise stated.

PARAMETER	DESCRIPTION	MIN	TYP	MAX	UNIT
Operating Input Voltage		36	48	75	V
Input Current (full load) <sup>1</sup>	Test at 40 V input voltage	-	-	8	A
	Test at 36 V input voltage	-	-	8.5	A
Start Up Current	Test at 36 V input voltage, 100% load with 5000 µF Co.	-	7	12	A
Input Current (no load)		-	60	100	mA
Remote Off Input Current		-	3	6	mA
Input Reflected Ripple Current (rms)	With simulated source impedance of 10 µH, 5 Hz to 20 MHz. Use a 100 µF/100 V electrolytic capacitor with ESR = 1 ohm max, at 200 kHz @ 25°C.	-	2	-	mA
Input Reflected Ripple Current (pk-pk)		-	10	20	mA
Input Voltage Ripple Rejection	120 Hz	-	60	-	db
Input Reflected Ripple Voltage (rms)	With simulated source impedance of 10 µH, 5 Hz to 20 MHz. Use a 100 µF/100 V electrolytic capacitor with ESR = 1 ohm max, at 200 kHz @ 25°C.	-	35	-	mV
Input Reflected Ripple Voltage (pk-pk)		-	130	-	mV
I <sup>2</sup> t Inrush Current Transient <sup>2</sup>		-	-	2	A <sup>2</sup> s
Turn-on Voltage Threshold		-	34	35	V
Turn-off Voltage Threshold		32	33	-	V
Vin Lockout Hysteresis Voltage		1	2	3	V
Inrush Current		-	-	10	A

**CAUTION: This converter is not internally fused. An input line fuse must be used in application.**

Recommend a fast-acting fuse with maximum rating of 15 A on system board. Refer to the fuse manufacture's datasheet for further information.

**Note:** <sup>1</sup> When Vin = 36V~40 V, the output voltage will decrease to 10 V, refer to the "5. OUTPUT SETPOINT VS. INPUT PLOT".

<sup>2</sup> Test condition please refer to the "10. Test condition and Parameter".

## 4. OUTPUT SPECIFICATIONS

All specifications are typical at nominal input, full load at 25°C unless otherwise stated.

PARAMETER	DESCRIPTION	MIN	TYP	MAX	UNIT
Output Voltage Set Point	Vin = 48 V, Io = 50% load at 25°C ambient.	11.76	12.00	12.24	V
Load Regulation	Vin = 40 – 75 V, Io = 0~100% load at 25°C ambient.	-	20	100	mV
Line Regulation	Vin = 36 – 75 V, Io = 100% load	1.8	2.0	2.2	V
	Vin = 40 – 75 V, Io = 100% load	-	20	100	mV
Regulation Over Temperature (-40°C to 85°C)	Vin = 40- 75 V	-	20	100	mV
Total Output Voltage Range	Over sample load and temperature	10.2	-	12.2	V
Output Ripple and Noise(Pk-Pk)	Vin = 48 V, Io=100% load, 0 – 20 MHz BW, with a 1 µF ceramic capacitor, a 10 µF Tantalum cap and a 270 µF AL cap at output.	-	50	100	mV
Output Ripple and Noise(RMS)		-	10	20	mV
Output Ripple and Noise(Pk-Pk) under worst case	Over entire operating input voltage range, load and ambient temperature condition.	-	-	150	mV
Output Current Range		0	-	20	A
Output DC Current Limit <sup>①</sup>		23	28	33	A
Short Circuit Surge Transient	Iout surge	-	-	1	A <sup>2</sup> s
Rise Time		-	10	15	ms
Turn on Time	Ton (Enable form Vin)	-	25	30	ms
	Ton (Enable form ON/OFF)	-	25	30	ms
Overshoot at Turn on		-	0	3	%
Output Capacitance		270	-	6800	µF
<b>Transient Response</b>					
ΔV 50%~75% of Max Load		-	300	400	mV
Settling Time	di/dt = 0.1 A/µs, Vin = 48 VDC, with a 1 µF ceramic capacitor, a 10 µ Tantalum cap and a 270 µF AL cap at output.	-	500	-	µs
ΔV 75%~50% of Max Load		-	300	400	mV
Settling Time		-	500	-	µs

**Note**<sup>①</sup>: Hiccup mode.

Before the over current protection, the output voltage won't decrease even the load increase.

5. OUTPUT SETPOINT VS. INPUT PLOT

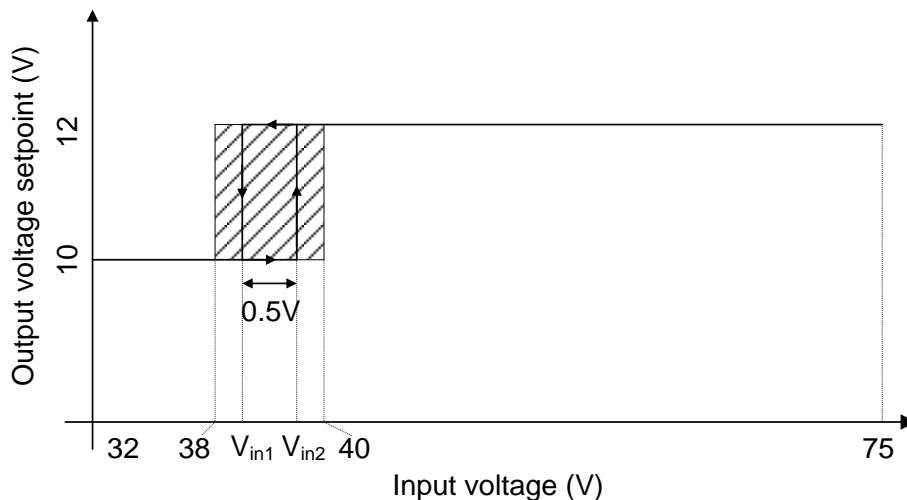

Figure 1. Output setpoint vs. input plot

- Notes:** 1. Output voltage set point is set to 2 different values according to the input voltage range, and the boundary of the input voltage range is within 38 – 40 V.  
 2. There is a ~0.5 V hysteresis between Vo setpoint-changing thresholds (shown as Vin1 and Vin2 above).

6. GENERAL SPECIFICATIONS

PARAMETER	DESCRIPTION	MIN	TYP	MAX	UNIT
Efficiency (Vin =48V; Io=0.5Iomax)	The efficiency is measured at Vin = 48 V, full load	-	95.5	-	%
Switching Frequency		-	350	-	kHz
Over Temperature Protection		-	125	-	°C
Output Over Voltage Protection		-	13.6	-	V
FIT	Calculated Per Bell Core SR-332 (Vin = 48 V, Vo = 12 V, Io = 16 A, Ta = 25°C, FIT = 10 <sup>9</sup> /MTBF)	-	142	-	-
MTBF			7000000		hours
Weight		-	33.7	-	g
Dimensions (L x W x H)			2.30 x 0.90 x 0.45		inch
			58.42 x 22.86 x 11.50		mm
<b>Isolation Characteristics</b>					
Input to Output		-	-	2250	V
Isolation Resistance		10M	-	-	Ohm
Leakage Current		-	-	1	mA
Isolation Capacitance		-	1000	-	pF

**Note:** All specifications are typical at 25 °C unless otherwise stated.



Asia-Pacific  
+86 755 298 85888

Europe, Middle East  
+353 61 225 977

North America  
+1 408 785 5200

### 7. EFFICIENCY DATA

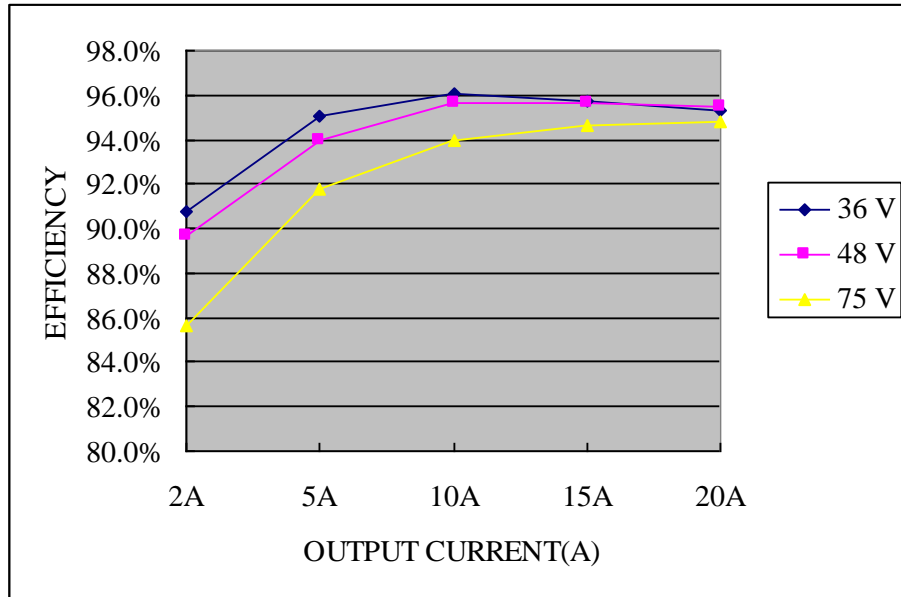

Figure 2. Efficiency data

8. REMOTE ON/OFF

PARAMETER	DESCRIPTION	MIN	TYP	MAX	UNIT
Signal Low (Unit On)	Active Low	-0.3	-	0.8	V
Signal High (Unit Off)	Remote On/Off pin is open, the module is off.	2.4	-	18	V
ON/OFF Current 1	Von/off = 0.0 V	-	13	-	uA
ON/OFF Current 2	Von/off = 2.4 V	-	10	-	uA
Current Sink		0	-	1	mA

Recommended remote on/off circuit for active low

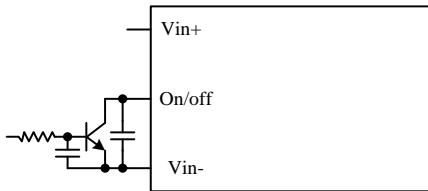

Figure 3. Control with open collector/drain circuit

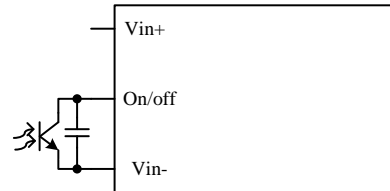

Figure 4. Control with photocoupler circuit

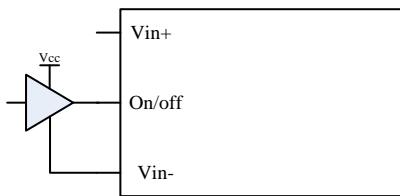

Figure 5. Control with logic circuit

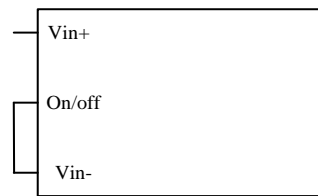
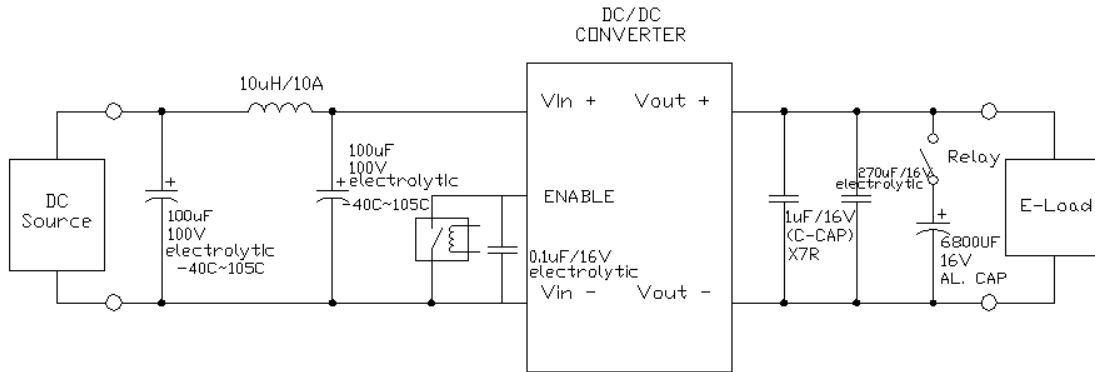

Figure 6. Permanently on

9. TEST CONDITION AND PARAMETER



Ckt Code	Description	Remark
C1	100µF/100V electrolytic cap, -40C~105C	
C2	NIL	
L1	10µH/10A	For input reflected ripple current test
C3	100µF/100V electrolytic cap, -40C~105C	For input reflected ripple current test
C4	NIL	
C5	1µF/16V Ceramic Cap, X7R	For output ripple/noise test
C6	270µF/16V electrolytic cap	
C7	6800µF/16V AL. cap	For start-up time test with capacitive load
C8	0.1µF/16V electrolytic cap	
K1	Relay	For start-up time test with capacitive load

Figure 7. Test condition and parameter

10. RIPPLE AND NOISE WAVEFORM

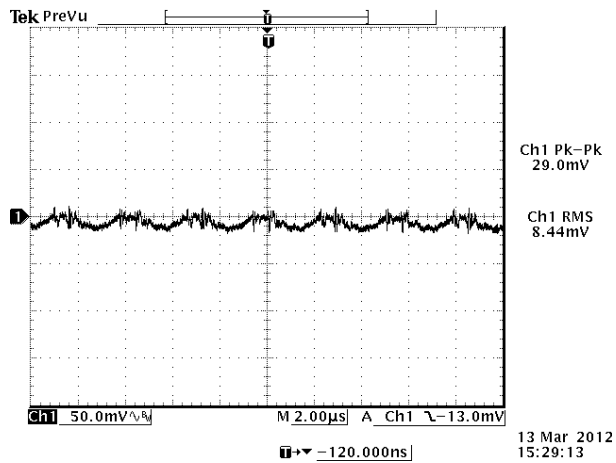

Figure 8. Ripple and noise waveform

**Note:** Ripple and noise at full load, 48 VDC input, 12 VDC / 20 A output and Ta = 25 °C, and with a 1 µF ceramic capacitor, a 10 µF Tantalum cap and a 270 µF AL.cap at output.



## 11. TRANSIENT RESPONSE WAVEFORMS

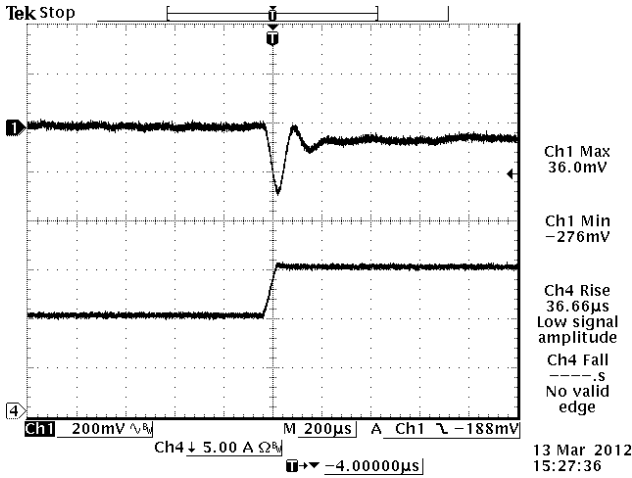

Figure 9.  $V_{out} = 12\text{ V}$ , 50% - 75% Load Transients at  $V_{in} = 48\text{ V}$  @  $T_a = 25^\circ\text{C}$

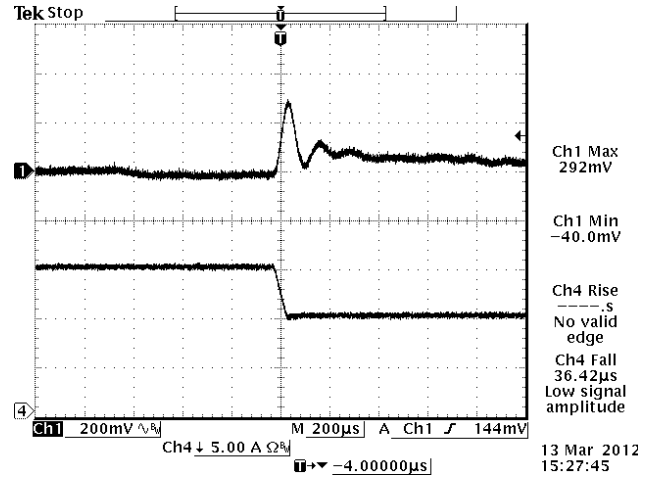

Figure 10.  $V_{out} = 12\text{ V}$ , 75% - 50% Load Transients at  $V_{in} = 48\text{ V}$  @  $T_a = 25^\circ\text{C}$

**Note:** Transient Response:  $di/dt = 0.1\text{ A}/\mu\text{s}$ , with a  $1\text{ }\mu\text{F}$  ceramic capacitor, a  $10\text{ }\mu\text{F}$  Tantalum cap and a  $270\text{ }\mu\text{F}$  AL cap at output.

## 12. STARTUP & SHUTDOWN

Rise time

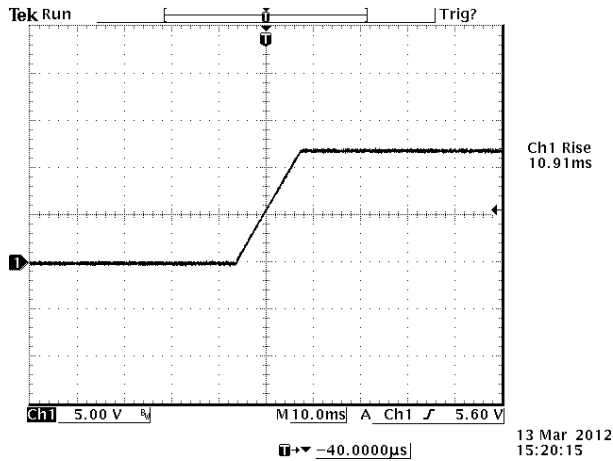

Figure 11.  $V_{out} = 12\text{ V} / 20\text{ A}$  at  $V_{in} = 48\text{ V}$  @  $T_a = 25^\circ\text{C}$   $C_{ext} = 270\text{ }\mu\text{F}$

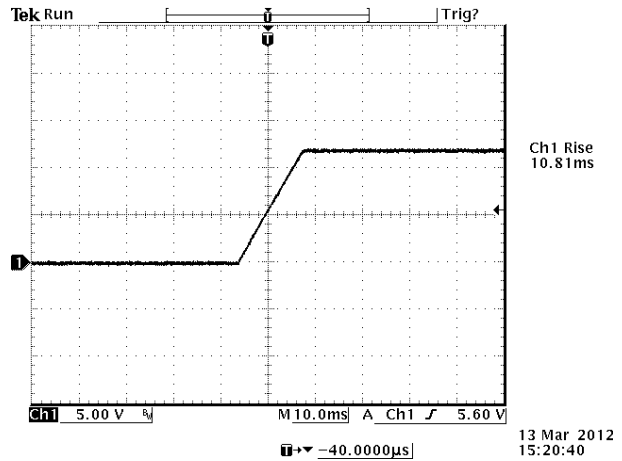

Figure 12.  $V_{out} = 12\text{ V} / 20\text{ A}$  at  $V_{in} = 48\text{ V}$  @  $T_a = 25^\circ\text{C}$   $C_{ext} = 6800\text{ }\mu\text{F}$

Startup time

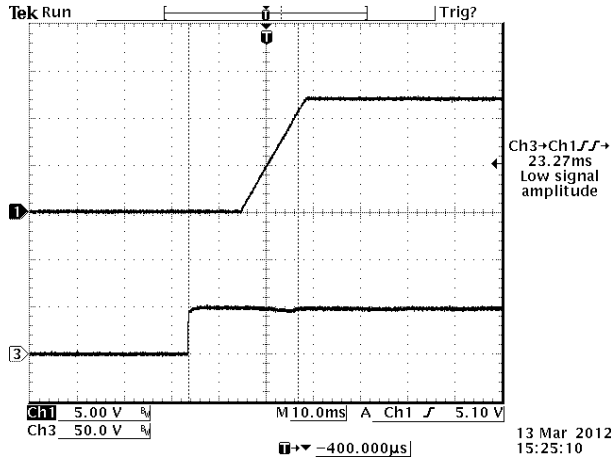

Figure 13. Startup from Vin  
Ch1: Vo  
Ch3: Vin  
Vout = 12 V / 20 A at Vin = 48 V @Ta = 25°C Cext = 6800 µF

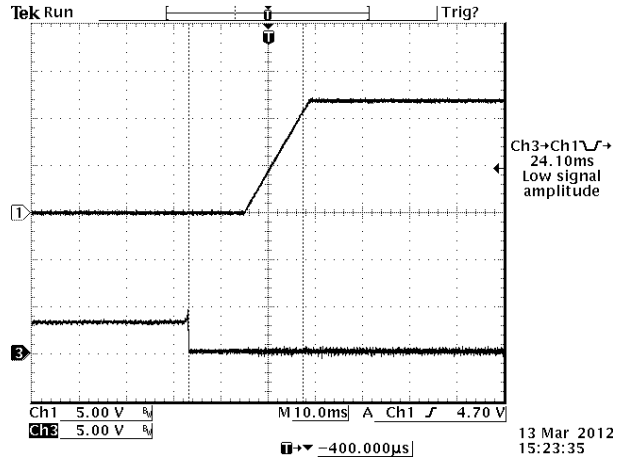

Figure 14. Startup from on/off  
Ch1: Vo  
Ch3: on/off  
Vout = 12 V / 20 A at Vin = 48 V @Ta = 25°C Cext = 6800 µF

Shutdown

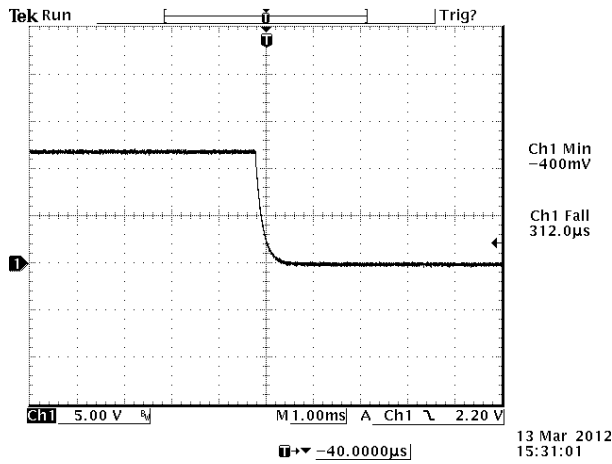

Figure 15. Vout = 12 V / 20 A at Vin = 48 V  
@Ta = 25°C Cext = 270 µF

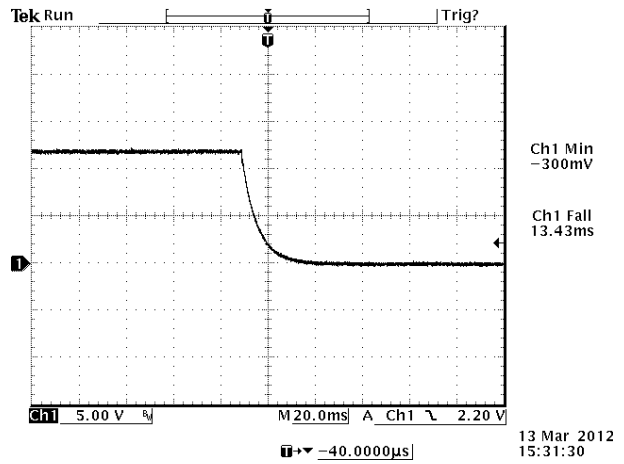

Figure 16. Vout = 12 V / 20 A at Vin = 48 V  
@Ta = 25°C Cext = 6800 µF

### 13. OVER CURRENT PROTECTION

To provide protection in a fault output overload condition, the module is equipped with internal over current protection circuitry. If the over current condition occurs, the module will shut down into hiccup mode and restart once every 400 ms. The module operates normally when the output current goes into specified range.

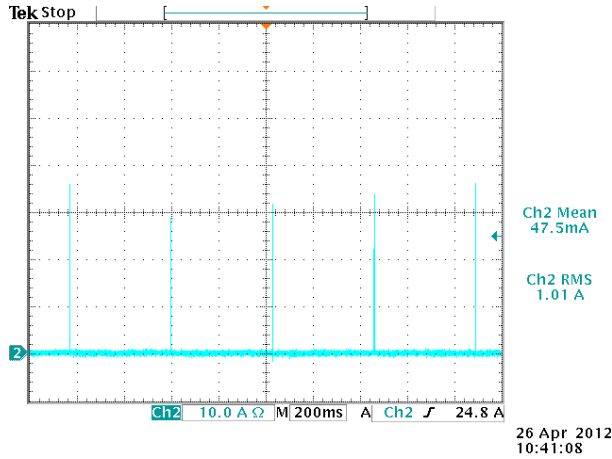

Figure 17.  $V_{in} = 48 V @ T_a = 25^{\circ}C$

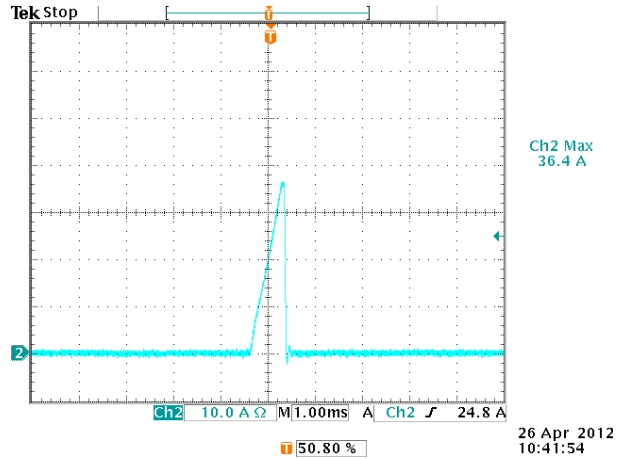

Figure 18. Expansion of on time portion of above figure  
CH2: Output current waveform

### 14. INPUT UNDER-VOLTAGE LOCKOUT

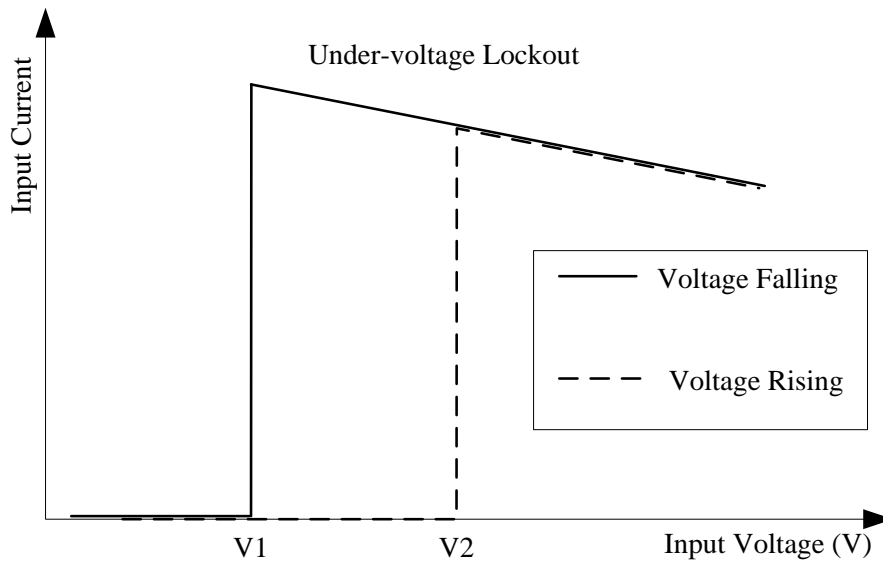

Figure 19. Input under-voltage lockout

$V1 = 33 V$

$V2 = 34.5 V$

### 15. THERMAL DERATING CURVE

Maximum FET junction temperature derated to 120 °C

The OTP is achieved by temperature sensor U10 and it's in non-latch mode when the hottest component U7 reaches 115°C with 200LFM air flow correspondingly. It will restart automatically when the temperature falls to 105°C. The protecting point will be varied a little under different conditions (air flow, ambient temperature, input voltage, load...).

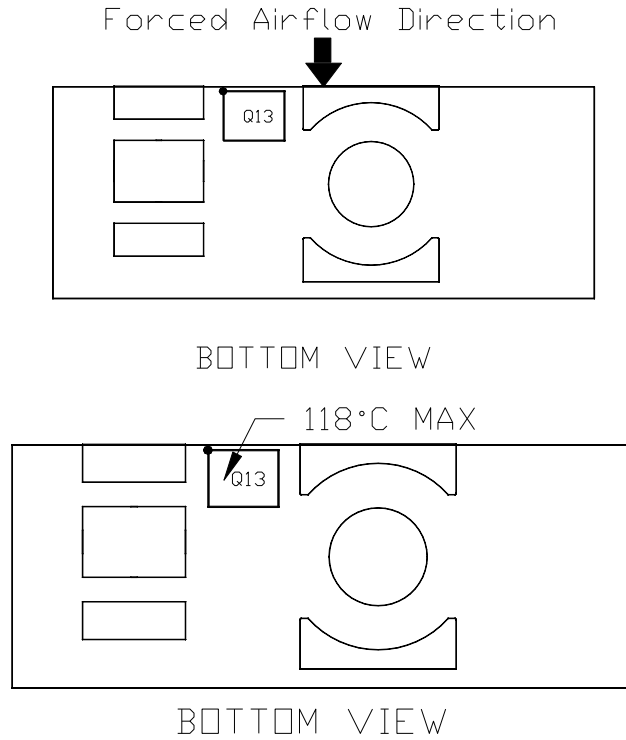

Figure 20. Temperature reference point and forced airflow direction on bottom side

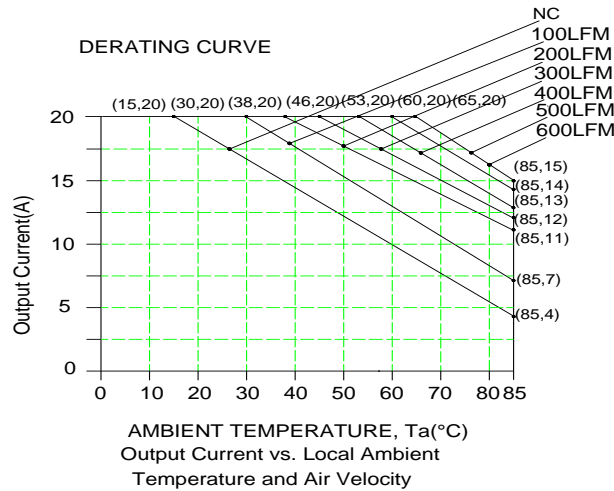

Figure 21. Vin = 48 V thermal derating curve  
Open frame version

## 16. SAFETY & EMC

### SAFETY:

Material flammability: UL94V-0  
 CB certification to IEC/EN 60950-1  
 UL certification to UL/CSA 60950-1  
 CB certification to IEC/EN 62368-1  
 UL certification to UL/CSA 62368-1

### EMC:

Compliance to EN 55032 class A (both peak and average) with the following inductive and capacitive filter.

### Test setup:

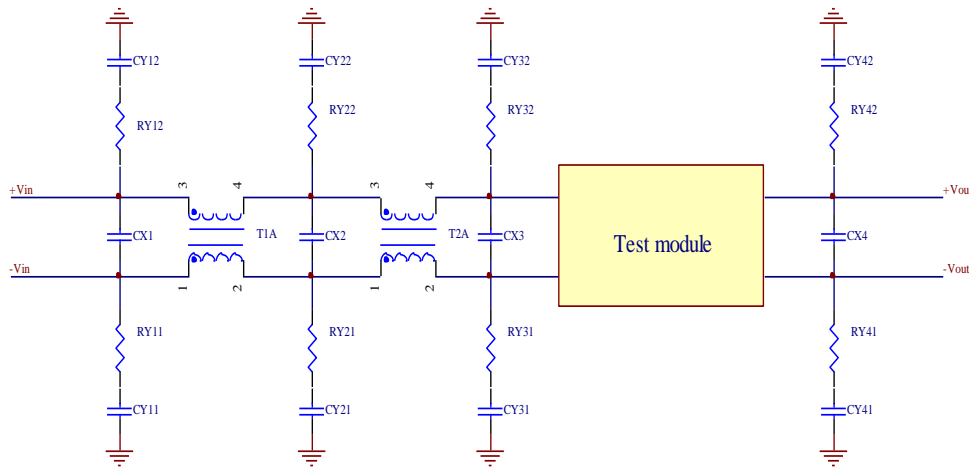

Figure 22. Test setup

ITEM	DESIGNATOR	PARAMETER	VENDOR	VENDOR P/N
1	CX2	100µF/100V, AL cap		
2	CX3	220µF/100V, AL cap		
3	CY31	2*6.8nF/1000V, ceramic		
4	CY32	2*6.8nF/1000V, ceramic		
5	CY41	6.8nF/1000V, ceramic		
6	CY42	6.8nF/1000V, ceramic		
7	RY31	1206,0R, Resistor		
8	RY32	1206,0R, Resistor		
9	RY41	1206,0R, Resistor		
10	RY42	1206,0R, Resistor		
11	T2A	0.81mH, common mode		
12	T1A, CX1, CX2 RY11, RY21, RY12 RY22, CY11, CY21 CY12, CY22	NIL		

Positive:

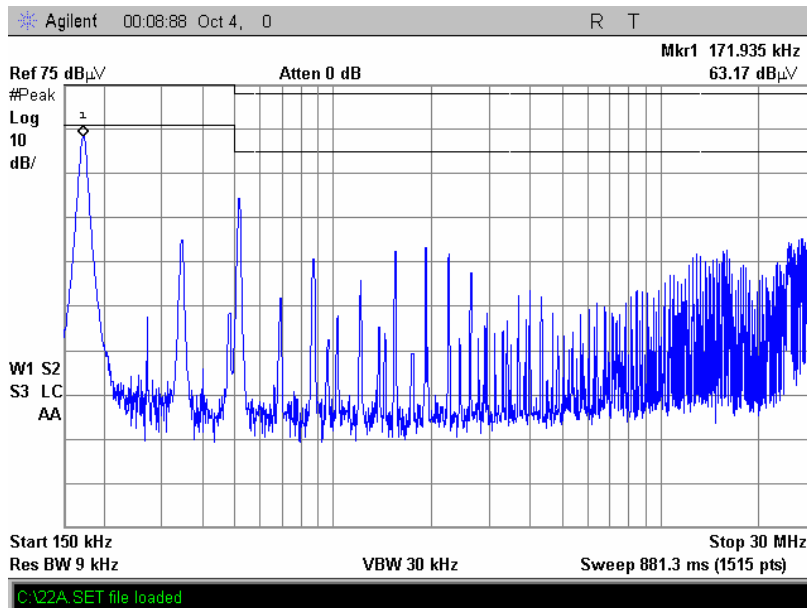

Figure 23.

Negative:

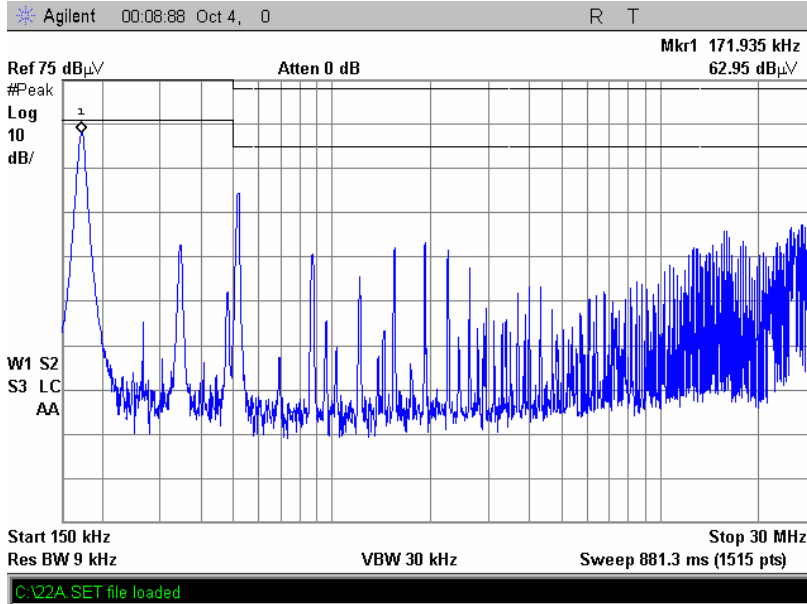

Figure 24.

17. MECHANICAL DIMENSIONS

OUTLINE

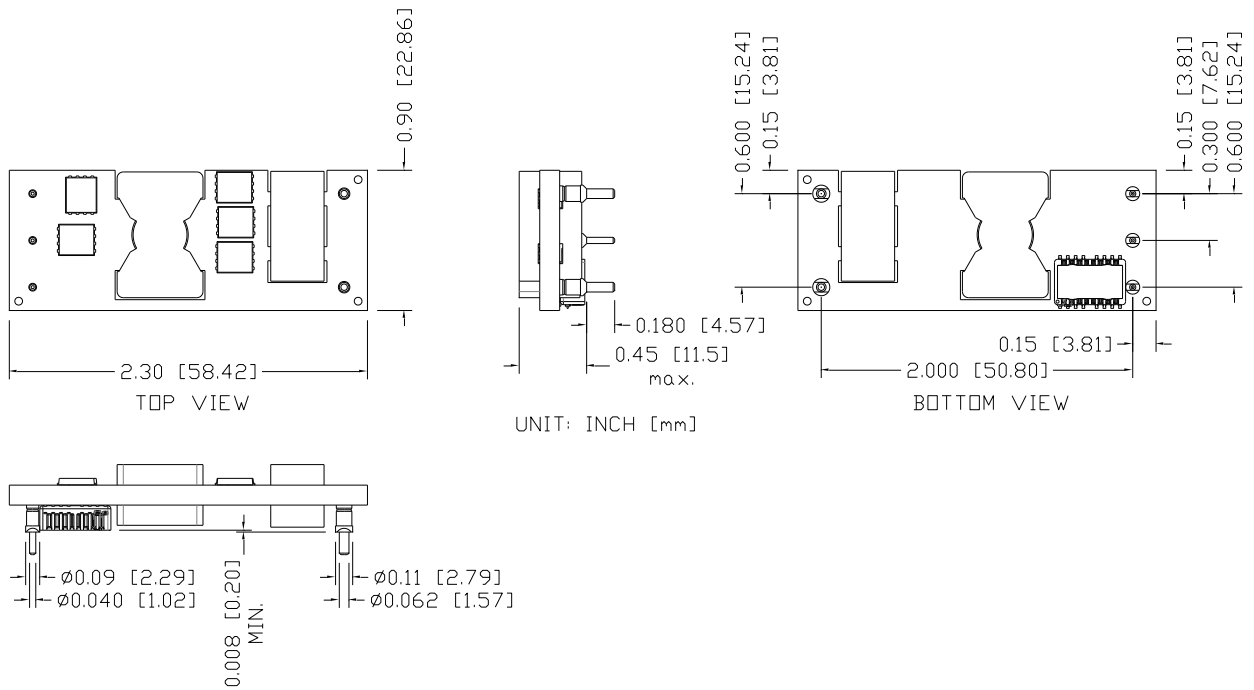

Figure 25. Outline

**NOTE:** This module is recommended and compatible with Pb-Free Wave Soldering and must be soldered using a peak solder temperature of no more than 260 °C for less than 5 seconds.

**NOTES:**

- 1) All Pins: Material - Copper Alloy;  
Finish – 3 micro inches minimum Gold over 50 micro inches minimum Nickel plate.
- 2) Un-dimensioned components are shown for visual reference only.
- 3) All dimensions in inch [mm]; Tolerances: x.xx +/-0.02 inch [0.51 mm]. x.xxx +/-0.010 inch [0.25 mm].

**PIN DEFINITIONS**

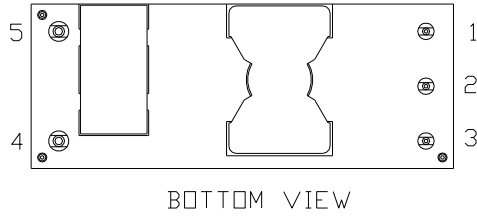

BOTTOM VIEW

Figure 26. Pins

PIN	NAME	PIN SIZE
1	Vin (+)	0.04"
2	ON/OFF	0.04"
3	Vin (-)	0.04"
4	Vout (-)	0.06"
5	Vout (+)	0.06"

**RECOMMENDED PAD LAYOUT**

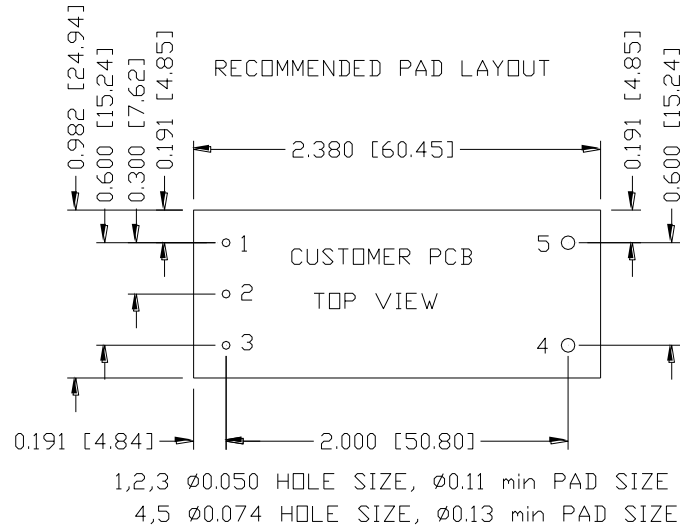

Figure 27. Recommended pad layout



**18. REVISION HISTORY**

DATE	REVISION	CHANGES DETAIL	APPROVAL
2016-12-16	AA	First release.	XF.Jiang
2018-03-23	AB	Update Input Specifications, Output Specifications and General Specifications, add Test Condition and Parameter.	J.Yao
2018-04-20	AC	Update Input Specifications, Output Specifications and General Specifications, and Remote on/off.	DW.Ren
2018-05-16	AD	Update TD and Input Specs.	DW.Ren
2021-03-01	AE	Update safety certificate.	XF.Jiang
2021-05-05	AF	Add object ID.	XF.Jiang

For more information on these products consult: [tech.support@psbel.com](mailto:tech.support@psbel.com)

**NUCLEAR AND MEDICAL APPLICATIONS** - Products are not designed or intended for use as critical components in life support systems, equipment used in hazardous environments, or nuclear control systems.

**TECHNICAL REVISIONS** - The appearance of products, including safety agency certifications pictured on labels, may change depending on the date manufactured. Specifications are subject to change without notice.



**Asia-Pacific**  
+86 755 298 85888

**Europe, Middle East**  
+353 61 225 977

**North America**  
+1 408 785 5200