

CDBHD120L-G Thru. CDBHD1100L-G

Reverse Voltage: 20 to 100 Volts

Forward Current: 1.0 Amp

RoHS Device

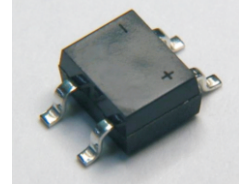

Features

- Low Vf Schottky barrier chips in bridge
- Metal-Semiconductor junction with guard ring
- High surge current capability
- Silicon epitaxial planar chips
- For use in low voltage, high efficiency inverters, free wheeling, and polarity protection applications
- Lead-free part, meet RoHS requirements

Mechanical data

- Case: Mini-Dip bridge (TO-269AA) plastic molded case
- Epoxy: UL94-V0 rated flame retardant
- Terminals: Solderable per MIL-STD-750 Method 2026
- Polarity: As marked on body
- Mounting Position: Any
- Weight: 0.0078 ounces, 0.22 grams

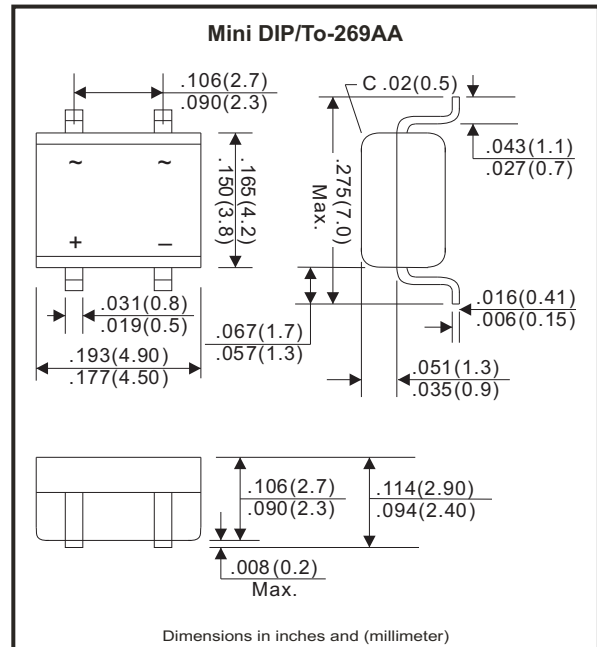

Maximum Ratings and Electrical Characteristics

Parameter	Symbol	CDBHD 120L-G	CDBHD 140L-G	CDBHD 160L-G	CDBHD 180L-G	CDBHD 1100L-G	Units	
Maximum repetitive peak reverse voltage	V_{RRM}	20	40	60	80	100	V	
Maximum DC blocking voltage	V_{DC}	20	40	60	80	100	V	
Maximum RMS voltage	V_{RMS}	14	28	42	56	70	V	
Peak surge forward current 8.3ms single half sine-wave superimposed on rate load (JEDEC method)	I_{FSM}	30.0						A
Max. average forward current 0.2"x0.2"(5.0x5.0mm)copper pad area,see Figure 1	I_{AV}	1.0						A
Max. instantaneous forward voltage at 1.0A (Note 1)	V_F	0.44		0.625		0.75	V	
Max. DC reverse current at rated DC blocking voltage	$T_A=25^{\circ}C$	I_R					mA	
	$T_A=100^{\circ}C$	20.0						
Typical junction Capacitance (Note 2)	C_J	250			125		Pf	
Typical thermal resistance (Note 3)	$R_{\theta JA}$	85.0					$^{\circ}C/W$	
	$R_{\theta JL}$	20.0						
Operating junction temperature Range	T_J	-55 to +125					$^{\circ}C$	
Storage temperature Range	T_{STG}	-55 to +150					$^{\circ}C$	

Note 1. Pulse test: 300µs pulse width, 1% duty cycle
 2. Measured at 1.0MHz and applied reverse voltage of 4.0 Volts
 3. Thermal resistance from junction to ambient and from junction to lead P.C.B. mounted on 0.2x0.2"(5.0x5.0mm) copper pad areas.

RATING AND CHARACTERISTIC CURVES (CDBHD120L-G thru CDBHD1100L-G)

Fig.1 Forward Current Derating Curve

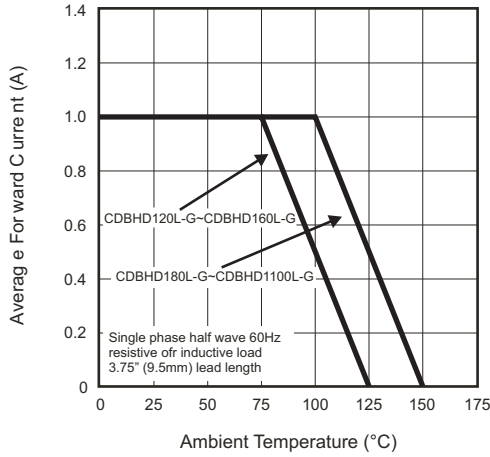

Fig.2 Maximum Non-Repetitive Peak Forward Surge Current

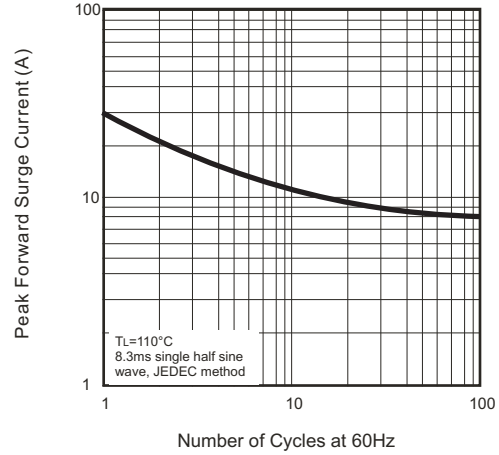

Fig.3- Typical Instantaneous Forward Characteristics

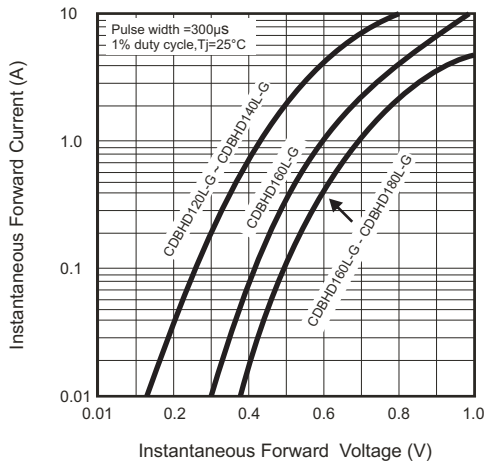

Fig.4A- Typical Reverse Characteristics

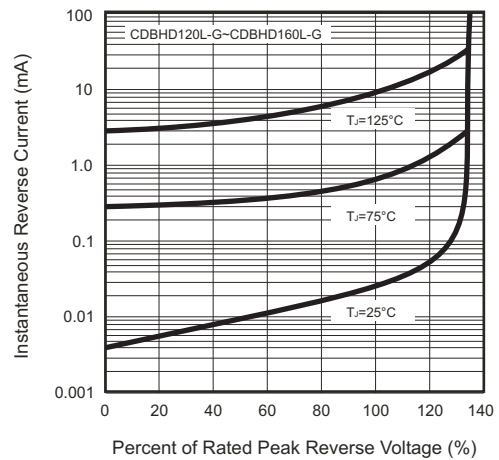

Fig.5 Maximum Non-Repetitive Peak Forward Surge Current

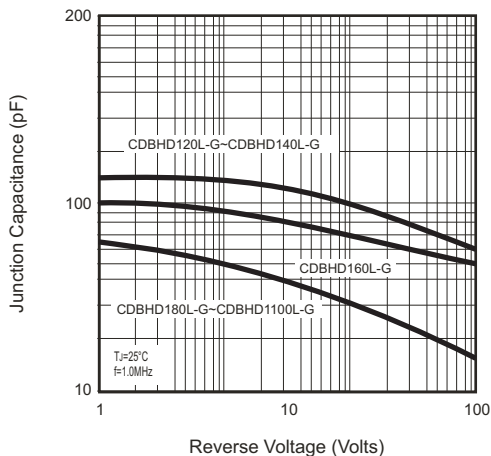
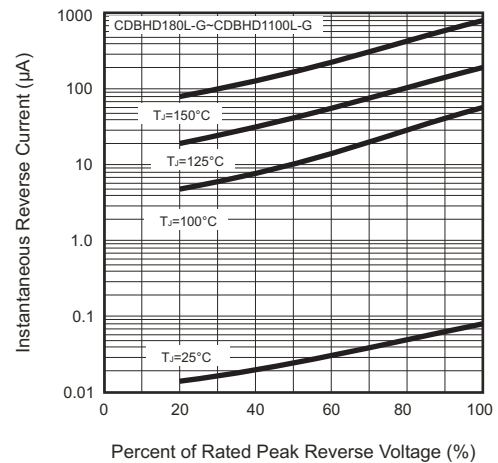
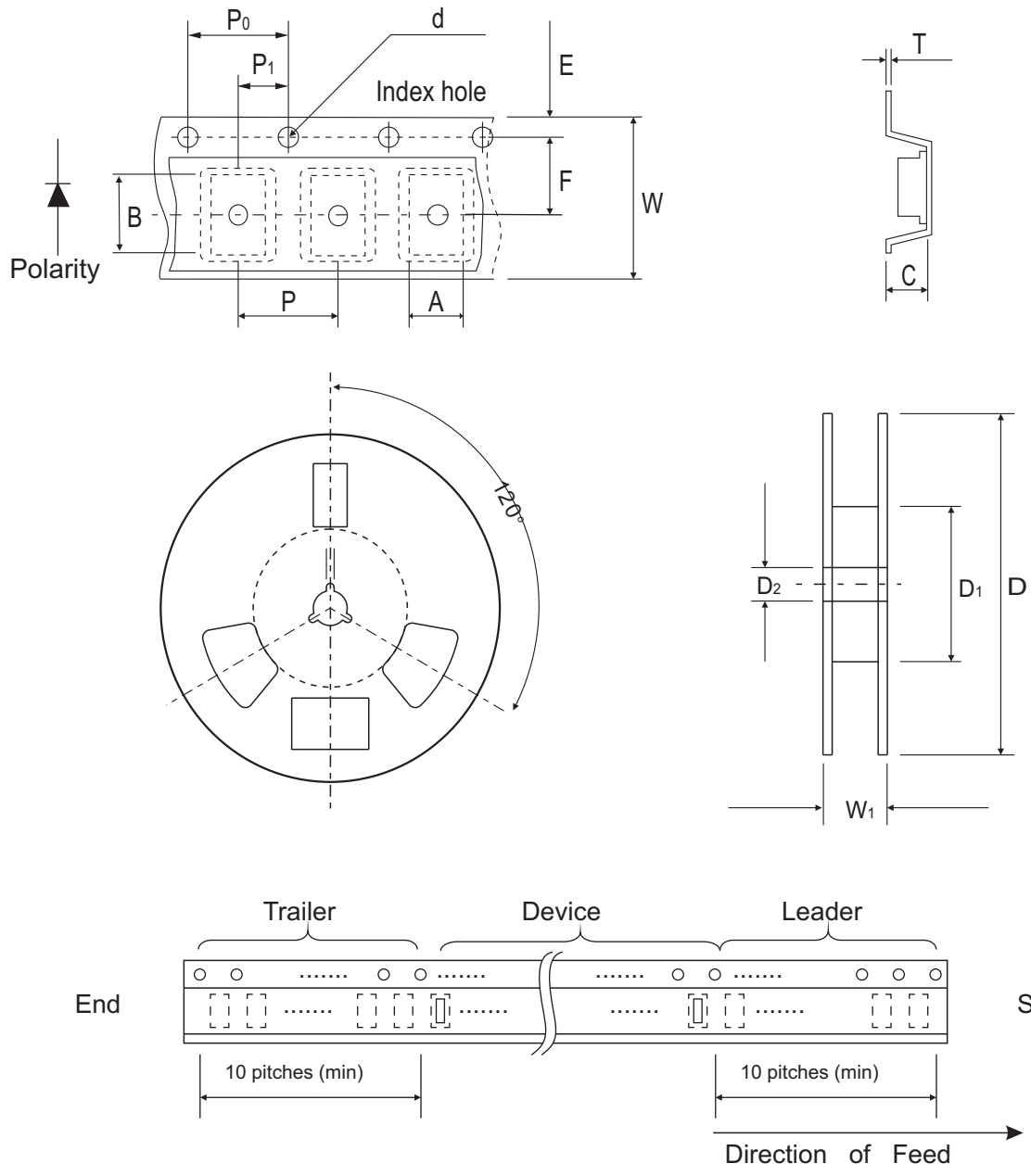

Fig.4B- Typical Reverse Characteristics



Reel Taping Specification



Mini-DIP/TO-269AA	SYMBOL	A	B	C	d	D	D1	D2
	(mm)	5.00 ± 0.10	3.20 ± 0.10	2.90 ± 0.10	1.55 ± 0.10	330MAX	50 MIN.	13.00 ± 0.20
	(inch)	0.197 ± 0.004	0.126 ± 0.004	0.114 ± 0.004	0.061 ± 0.004	12.992MAX	1.969 MIN.	0.512 ± 0.008

Mini-DIP/TO-269AA	SYMBOL	E	F	P	P0	P1	W	W1
	(mm)	1.75 ± 0.10	5.50 ± 0.10	8.00 ± 0.10	4.00 ± 0.10	2.00 ± 0.05	12.00 ± 0.20	18.40 MAX
	(inch)	0.069 ± 0.004	0.138 ± 0.004	0.315 ± 0.004	0.157 ± 0.004	0.079 ± 0.004	0.472 ± 0.008	0.724MAX

Marking Code

Part Number	Marking Code
CDBHD120L-G	MDS12L
CDBHD140L-G	MDS14L
CDBHD160L-G	MDS16L
CDBHD180L-G	MDS18L
CDBHD1100L-G	MDS110L

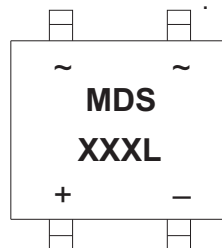

XXL / XXXL = Product type marking code

Suggested PAD Layout

SIZE	Mini-DIP/TO-269AA	
	(mm)	(inch)
A	6.91Min	0.272Min
B	0.58Min	0.023Min
C	0.76Min	0.030Min
D	2.67Min	0.105Min

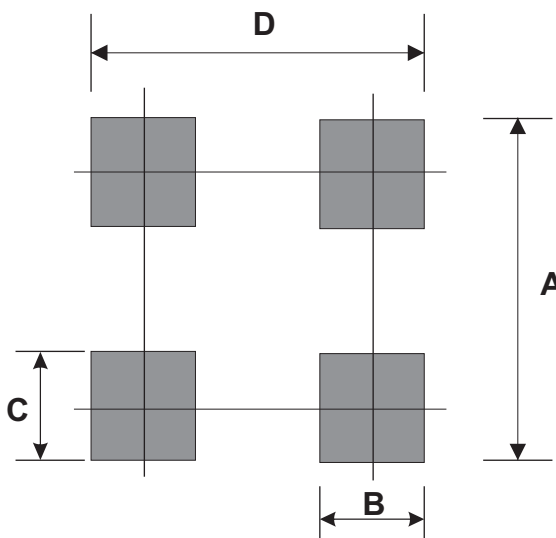

Standard Packaging

Case Type	REEL PACK	
	REEL (pcs)	Reel Size (inch)
Mini-DIP/TO-269AA	2,500	13