



# WS/WE24-2R240

W24-2

PHOTOELECTRIC SENSORS

**SICK**  
Sensor Intelligence.



Illustration may differ



### Ordering information

Type	Part no.
WS/WE24-2R240	1017864

Other models and accessories → [www.sick.com/W24-2](http://www.sick.com/W24-2)

### Detailed technical data

#### Features

<b>Sensor/ detection principle</b>	Through-beam photoelectric sensor
<b>Dimensions (W x H x D)</b>	27 mm x 87.5 mm x 65 mm
<b>Housing design (light emission)</b>	Rectangular
<b>Sensing range max.</b>	0 m ... 60 m
<b>Sensing range</b>	0 m ... 50 m
<b>Type of light</b>	Visible red light
<b>Light source</b>	LED <sup>1)</sup>
<b>Light spot size (distance)</b>	Ø 700 mm (50 m)
<b>Angle of dispersion</b>	Approx. 1°
<b>Adjustment</b>	Potentiometer
<b>Time type</b>	On delay Off delay
<b>Delay time</b>	Adjustable via time delay selector switch, 0.5 s, 10 s

<sup>1)</sup> Average service life: 100,000 h at T<sub>J</sub> = +25 °C.

#### Communication interface

<b>Communication interface</b>	-
--------------------------------	---

#### Mechanics/electronics

<b>Supply voltage</b>	20 V AC/DC ... 250 V AC/DC <sup>1)</sup>
<b>Power consumption</b>	< 2 VA

<sup>1)</sup> Limit values; permitted cross-section: 0.14 ... 1.5 mm<sup>2</sup>.

<sup>2)</sup> Provide suitable spark suppression for inductive or capacitive loads.

<sup>3)</sup> With light/dark ratio 1:1.

<sup>4)</sup> A = V<sub>S</sub> connections reverse-polarity protected.

<sup>5)</sup> C = interference suppression.

<sup>6)</sup> Rated voltage: 250 V AC/DC.

<sup>7)</sup> Static, low heat output, use in +5° C ... +15° C.

<b>Output type</b>	Relay, electrically isolated <sup>2)</sup>
<b>Output function</b>	Change-over contacts
<b>Switching mode</b>	Light/dark switching <sup>2)</sup>
<b>Switching mode selector</b>	Selectable via light/dark selector
<b>Switching current (switching voltage)</b>	4 A (250 V AC) 4 A (24 V DC)
<b>Response time</b>	≤ 10 ms
<b>Switching frequency</b>	10 Hz <sup>3)</sup>
<b>Angle of reception</b>	Approx. 2.5°
<b>Connection type</b>	Terminal connection with M16 gland
<b>Circuit protection</b>	A <sup>4)</sup> C <sup>5)</sup>
<b>Protection class</b>	II <sup>6)</sup>
<b>Weight</b>	660 g
<b>Front screen heating</b>	✓ <sup>7)</sup>
<b>Housing material</b>	Metal, Zinc diecast
<b>Optics material</b>	Plastic, PMMA
<b>Enclosure rating</b>	IP67
<b>Usage category</b>	AC-15, DC-13, according to EN 60947-1
<b>Test input sender off</b>	TE to 0 V
<b>Ambient operating temperature</b>	-40 °C ... +60 °C
<b>Ambient storage temperature</b>	-40 °C ... +75 °C
<b>UL File No.</b>	NRKH.E181493 & NRKH7.E181493
<b>Part number of individual components</b>	2021159 WS24-2U240 2021163 WE24-2R240

<sup>1)</sup> Limit values; permitted cross-section: 0.14 ... 1.5 mm<sup>2</sup>.

<sup>2)</sup> Provide suitable spark suppression for inductive or capacitive loads.

<sup>3)</sup> With light/dark ratio 1:1.

<sup>4)</sup> A = V<sub>S</sub> connections reverse-polarity protected.

<sup>5)</sup> C = interference suppression.

<sup>6)</sup> Rated voltage: 250 V AC/DC.

<sup>7)</sup> Static, low heat output, use in +5° C ... +15° C.

## Classifications

<b>ECl@ss 5.0</b>	27270901
<b>ECl@ss 5.1.4</b>	27270901
<b>ECl@ss 6.0</b>	27270901
<b>ECl@ss 6.2</b>	27270901
<b>ECl@ss 7.0</b>	27270901
<b>ECl@ss 8.0</b>	27270901
<b>ECl@ss 8.1</b>	27270901
<b>ECl@ss 9.0</b>	27270901
<b>ETIM 5.0</b>	EC002716
<b>ETIM 6.0</b>	EC002716

UNSPSC 16.0901

39121528

### Adjustments possible

WT24-2, WL24-2, WS/WE24-2, AC/DC, with time functions

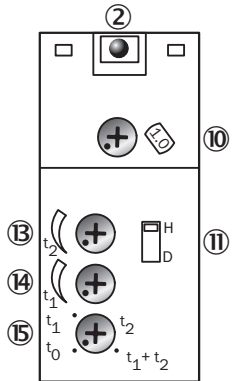

- ② LED signal strength indicator
- ⑩ Adjustment sensing range (WT) / sensitivity (WL, WS/WE)
- ⑪ Light/dark selector
- ⑫ Time control  $t_2$  = OFF delay
- ⑬ Time control  $t_1$  = ON delay
- ⑭ Time delay selector switch

### Connection diagram

Cd-127

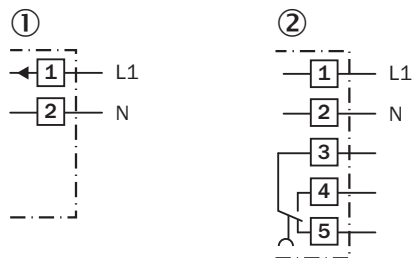

- ① Sender
- ② Receiver

### Characteristic curve

WS/WE24-2

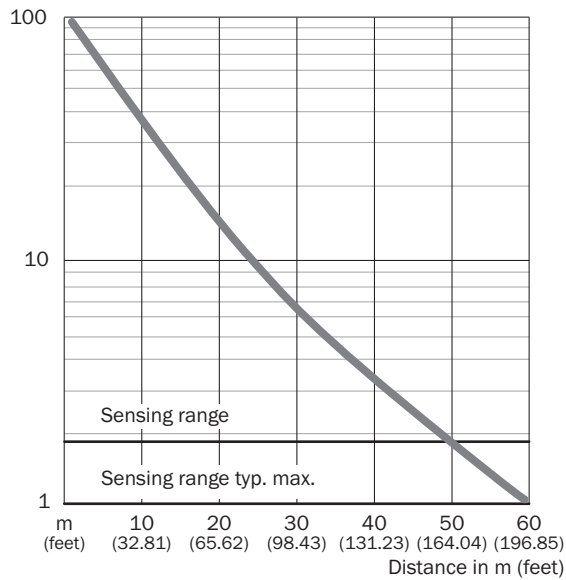

### Sensing range diagram

WS/WE24-2

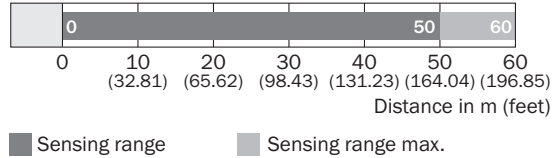

### Dimensional drawing (Dimensions in mm (inch))



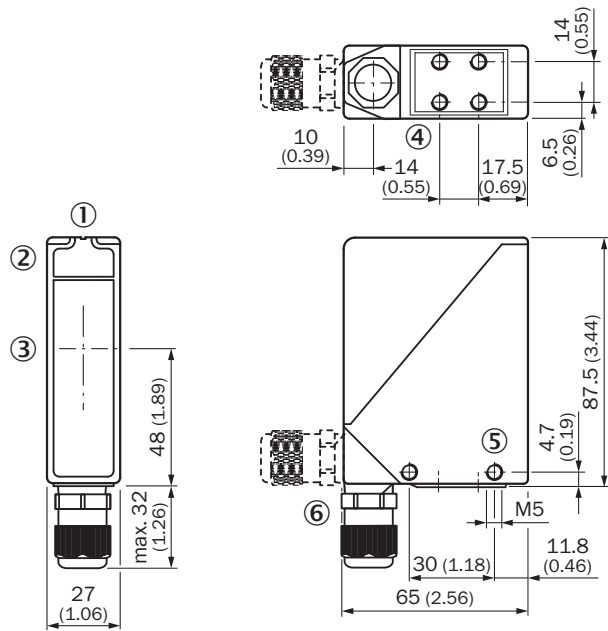

WS/WE24-2







- ① Alignment sight
- ② LED signal strength indicator
- ③ Center of optical axis
- ④ M5 threaded mounting hole, 6 mm deep
- ⑤ M5 threaded mounting hole, through-hole
- ⑥ M16 screw fixing and plug rotatable by 90°

### Recommended accessories

Other models and accessories → [www.sick.com/W24-2](http://www.sick.com/W24-2)

	Brief description	Type	Part no.
<b>Universal bar clamp systems</b>			
	Universal bar clamp for mounting bars with 12 mm diameter, Zinc diecast, without mounting plate and screws	BEF-KHS-KH3	5322626
	Plate N04 for universal clamp, steel, Zinc plated steel (sheet), Zinc die cast (clamping bracket), Universal clamp (5322626), mounting hardware	BEF-KHS-N04	2051610
<b>Device protection (mechanical)</b>			
	Water cooling plate	BEF-KP-W24	2015071
	Dust protection tube, air-purged, Aluminum (anodised), mounting hardware included	OBS-W24	2015069
	Weather hood for universal clamp bracket, steel, zinc coated, mounting hardware included	OBW-KHS-M01	2023240

	Brief description	Type	Part no.
	Weather hood, Aluminum (anodised), mounting hardware included	OBW-W24	2015070
		WSG1-01	1018470
Mounting brackets and plates			
	Mounting bracket, small, Stainless steel, without mounting hardware	BEF-WK-W24	4027532
	Mounting bracket, Stainless steel (1.4301), mounting hardware included	BEF-WN-W24	2015248
Alignment aids			
	Adapter for alignment aid AR60	Adapter AR60 for W24-2	4032976

## SICK AT A GLANCE

SICK is one of the leading manufacturers of intelligent sensors and sensor solutions for industrial applications. A unique range of products and services creates the perfect basis for controlling processes securely and efficiently, protecting individuals from accidents and preventing damage to the environment.

We have extensive experience in a wide range of industries and understand their processes and requirements. With intelligent sensors, we can deliver exactly what our customers need. In application centers in Europe, Asia and North America, system solutions are tested and optimized in accordance with customer specifications. All this makes us a reliable supplier and development partner.

Comprehensive services complete our offering: SICK LifeTime Services provide support throughout the machine life cycle and ensure safety and productivity.

For us, that is “Sensor Intelligence.”

## WORLDWIDE PRESENCE:

Contacts and other locations –[www.sick.com](http://www.sick.com)