

# PRODUCT SPECIFICATION

**Model No.: FYA-R1206BZX-XX**

## Descriptions & Features:

- Bargraph Digit Display
- Case mold type.
- RoHS compliant.
- Low current operation
- Low power consumption.
- Easy mounting on P.C. board or socket.



| CUSTOMER APPROVED SIGNATURES | APPROVED BY | CHECKED BY | PREPARED BY |
|------------------------------|-------------|------------|-------------|
|                              |             |            |             |

**NINGBO FORYARD OPTOELECTRONICS CO.,LTD**

**Add:**NO.115 Qixin Road Ningbo Zhejiang China

**Zip:**315051

**Tel:** 0086-574-87933652 87927870 87922206

**Fax:** 0086-574-87927917

**E-mail:**Sales@foryard.com (General)

[Http://www.foryard.com](http://www.foryard.com)

Model No.: FYA-R1206BZX-XX

■ -XX: REF Surface / Epoxy color

| Color \ Number    | 0                                 | 1                           | 2                          | 3                           | 4                            |
|-------------------|-----------------------------------|-----------------------------|----------------------------|-----------------------------|------------------------------|
| REF Surface Color | <input type="radio"/> White       | <input type="radio"/> Black | <input type="radio"/> Gray | <input type="radio"/> Red   | <input type="radio"/> Green  |
| Epoxy Color       | <input type="radio"/> Water Clear | <input type="radio"/> White | <input type="radio"/> Red  | <input type="radio"/> Green | <input type="radio"/> Yellow |

■ Mechanical Dimensions

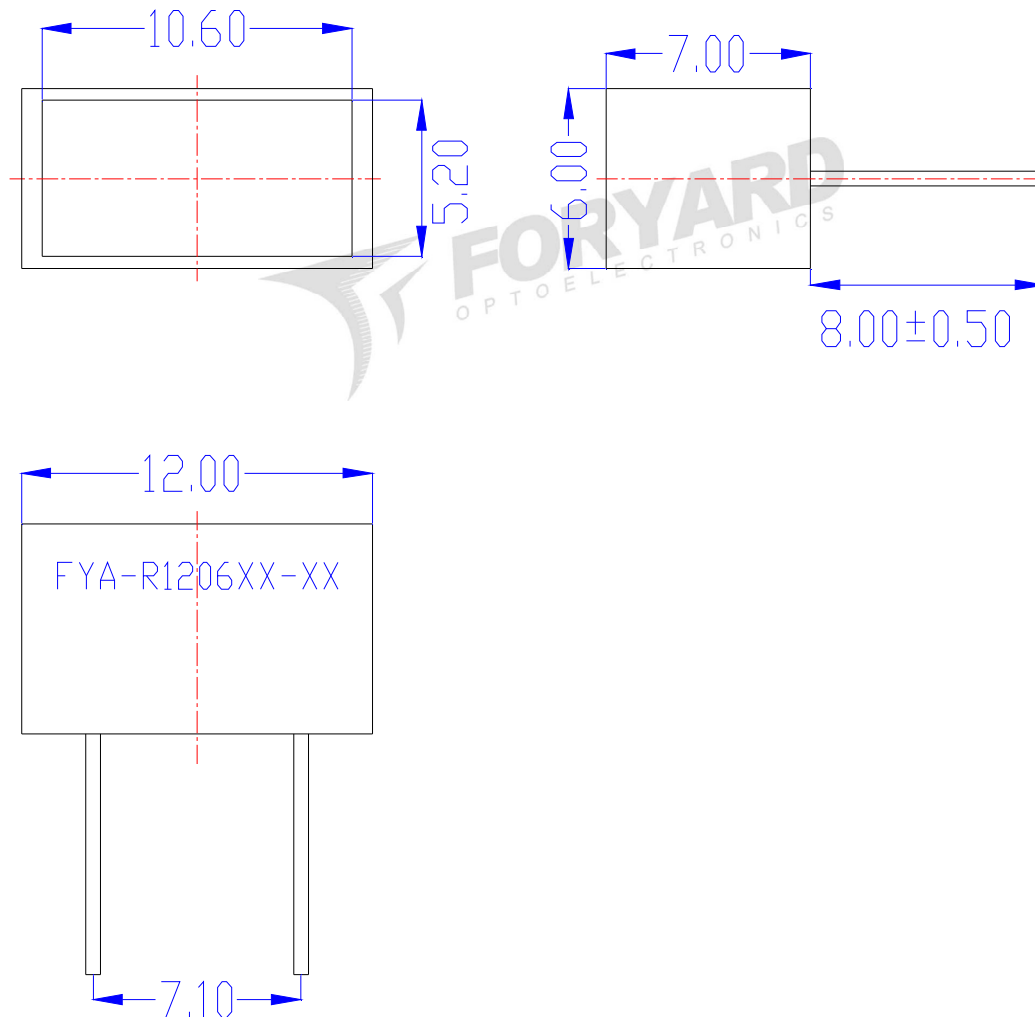

Notes:

1. All pins are  $\Phi 0.51 [ .020 ]$  mm
2. Dimension in millimeter [inch], tolerance is  $\pm 0.25 [ .010 ]$  and angle is  $\pm 1^\circ$  unless otherwise noted.
3. Bending  $\leq$  Length \* 1%.
4. The specifications, characteristics and technical data described in the datasheet are subject to change without prior notice.

Model No.: FYA-R1206BZX-XX

■ All Light On Segments Feature & Pin Position

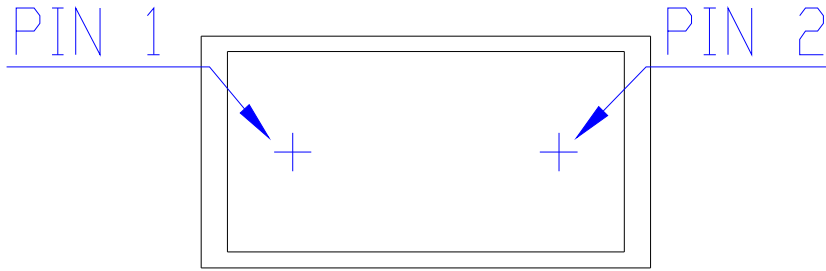

■ Internal Circuit Diagrams



**Model No.: FYA-R1206BZX-XX**

**■ Absolute maximum ratings**

(Ta=25°C)

| Parameter             | Symbol | Test Condition  | Value |     | Unit |
|-----------------------|--------|-----------------|-------|-----|------|
|                       |        |                 | Min   | Max |      |
| Reverse Voltage       | VR     | IR=30           | 5     | —   | V    |
| Forward Current       | IF     | —               | —     | 30  | mA   |
| Power Dissipation     | Pd     | —               | —     | 100 | mW   |
| Pulse Current         | Ipeak  | Duty=0.1mS,1KHz | —     | 150 | mA   |
| Operating Temperature | Topr   | —               | -40   | +85 | °C   |
| Storage Temperature   | Tstr   | —               | -40   | +85 | °C   |

**■ Electrical-Optical Characteristics**

● Color Code & Chip Characteristics:(Test Condition:IF=20mA)

(Ta=25°C)

| Emitting Color                                    | Dice Material      | Peak Wave Length( $\lambda_p$ ) | Spectral Line halfwidth( $\Delta\lambda_{1/2}$ ) | Forward Voltage(VF) Unit:V |      | Luminous Intensity (Iv) Unit:mcd |            |
|---|--------------------|---------------------------------|--|----------------------------|------|----------------------------------|------------|
|   |                    |                                 |  | Typ                        | Max  |                                  |            |
| <b>Standard brightness</b>                        |                    |                                 |  |                            |      |                                  |            |
| H   | Red                | GaP                             | 700nm  | 90nm                       | 2.00 | 2.50                             | 1          |
| S   | Hi Red             | AlGaAs/SH                       | 660nm  | 20nm                       | 1.80 | 2.50                             | 15~20      |
| D   | Super Red          | AlGaAs/DH                       | 650nm  | 20nm                       | 1.90 | 2.50                             | 26~38      |
| E   | Orange             | GaAsP                           | 625nm  | 35nm                       | 1.90 | 2.50                             | 14~20      |
| A   | Amber              | GaAsP                           | 610nm  | 35nm                       | 1.90 | 2.50                             | 13~18      |
| Y   | Yellow             | GaAsP                           | 590nm  | 35nm                       | 1.90 | 2.50                             | 13~18      |
| G   | Green              | GaP                             | 570nm  | 10nm                       | 1.90 | 2.50                             | 14~18      |
| B   | Blue               | InGaN                           | 430nm  | 60nm                       | 3.40 | 4.40                             | 0.7~1(mw)  |
|   |                    |                                 | 460nm  |                            | 2.80 | 3.80                             | 6~12(mw)   |
|   |                    |                                 | 470nm  |                            | 2.80 | 3.80                             | 6~12(mw)   |
| PG  | Pure Green         | InGaN                           | 520nm  | 36nm                       | 2.80 | 3.80                             | 4~6(mw)    |
| W   | White              | InGaN                           | X=0.29,Y=0.30                                    | CCT:9500K                  | 2.80 | 3.80                             | 20~30      |
| <b>Ultra brightness</b>                           |                    |                                 |  |                            |      |                                  |            |
| UHR   | Ultra Hi Red       | AlGaInP                         | 640nm  | 20nm                       | 1.90 | 2.50                             | 30~60      |
| UR  | Ultra Red          | AlGaInP                         | 635nm  | 20nm                       | 1.90 | 2.50                             | 60~100     |
| UE  | Ultra Orange       | AlGaInP                         | 625nm  | 20nm                       | 1.90 | 2.50                             | 60~120     |
| UA  | Ultra Amber        | AlGaInP                         | 610nm  | 20nm                       | 1.90 | 2.50                             | 40~100~150 |
| UY  | Ultra Yellow       | AlGaInP                         | 590nm  | 20nm                       | 1.90 | 2.50                             | 50~140~190 |
| UG  | Ultra Green        | AlGaInP                         | 570nm  | 30nm                       | 1.90 | 2.50                             | 30~60~80   |
| PG  | Ultra Pure Green   | InGaN                           | 520nm  | 36nm                       | 2.80 | 3.80                             | 260~310    |
| BG  | Ultra Bluish Green | InGaN                           | 505nm  | 36nm                       | 2.80 | 3.80                             | 260~310    |
| UB  | Ultra Blue         | InGaN                           | 460nm  | 30nm                       | 2.80 | 3.80                             | 80~90~120  |
|   |                    |                                 | 470nm  | 30nm                       | 2.80 | 3.80                             | 80~90~120  |
| UW  | Ultra White        | InGaN                           | X=0.29,Y=0.30                                    | CCT:9500K                  | 2.80 | 3.80                             | 180~200    |
| Segment-to-Segment Luminous Intensity ratio(Iv-M) |                    |                                 |  | 1.5:1                      |      |                                  |            |





Note:

- 1.Luminous Intensity is based on the Foryard standards.
- 2.Pay attention about static for InGaN

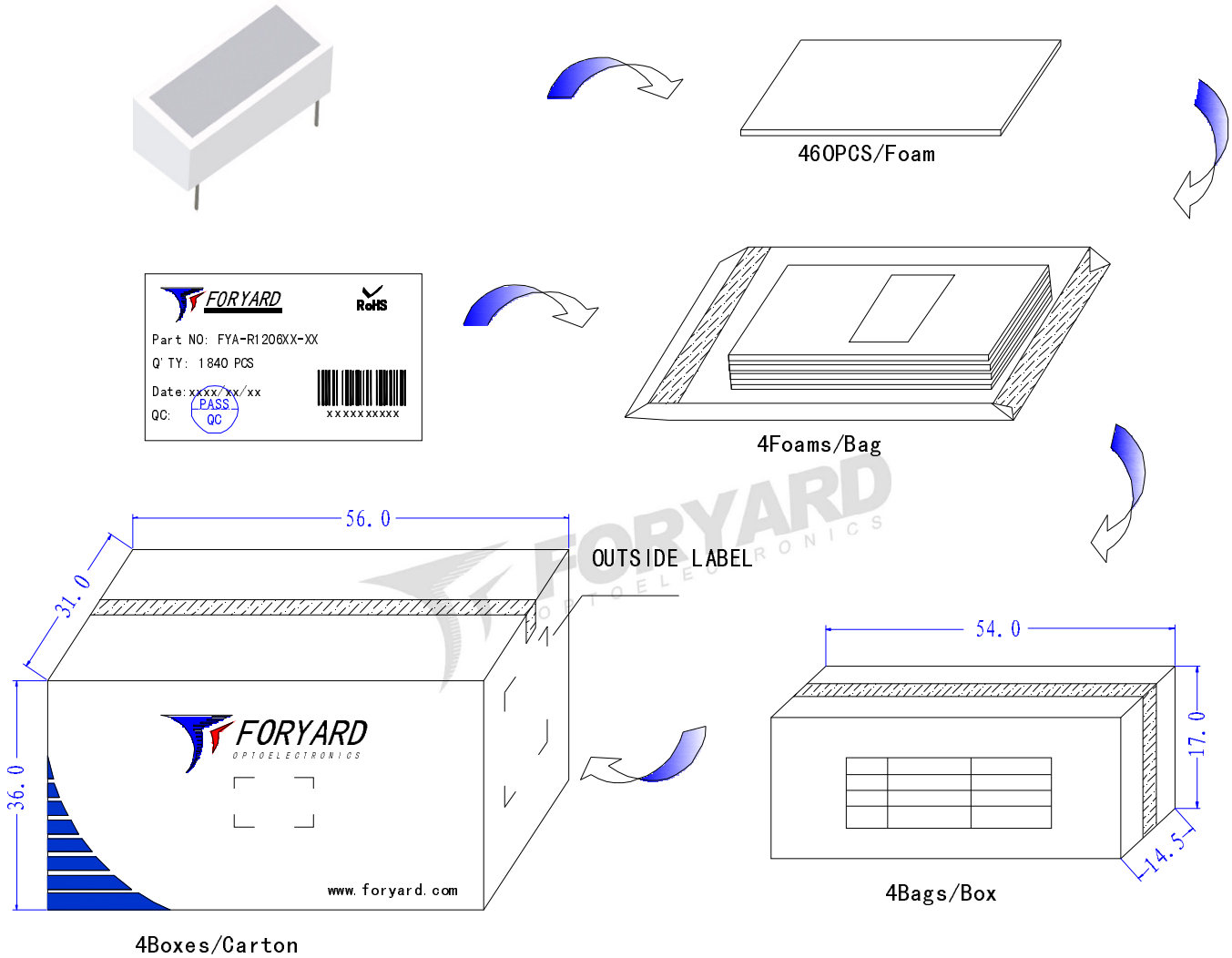
**Model No.: FYA-R1206BZX-XX**

**■ Packing Diagram**



  
 Part NO: FYA-R1206XX-XX  
 Q' TY: 1840 PCS  
 Date: xxxx/xx/xx  
 QC: 
  
 xxxxxxxxxxxx

  
**LED**  
 PN: FYA-R1206XX-XX  
 Qty: 29440 PCS  
 Date: xxxx/xx/xx  
 GW: 32.38KG      QC:   
 NW: 34.94KG  
  
 xxxxxxxxxxxx  



OUTSIDE LABEL

Note: The specifications are subject to change without notice. Please contact us for updated information.