

TRIACs, 8A

Snubberless, Logic Level and Standard

MAIN FEATURES

SYMBOL	VALUE	UNIT
$I_{T(RMS)}$	8	A
V_{DRM}/V_{RRM}	600 to 1000	V
$I_{GT(Q1)}$	5 to 50	mA

DESCRIPTION

The 8T triac series is suitable for general purpose AC switching. They can be used as an ON/OFF function in applications such as static relays, heating regulation, induction motor starting circuits... or for phase control operation in light dimmers, motor speed controllers,...

The snubberless and logic level versions are specially recommended for use on inductive loads, thanks to their high commutation performances.

By using an internal ceramic pad, the 8T series provides voltage insulated tab (rated at 2500VRMS) complying with UL standards (File ref. :E320098)

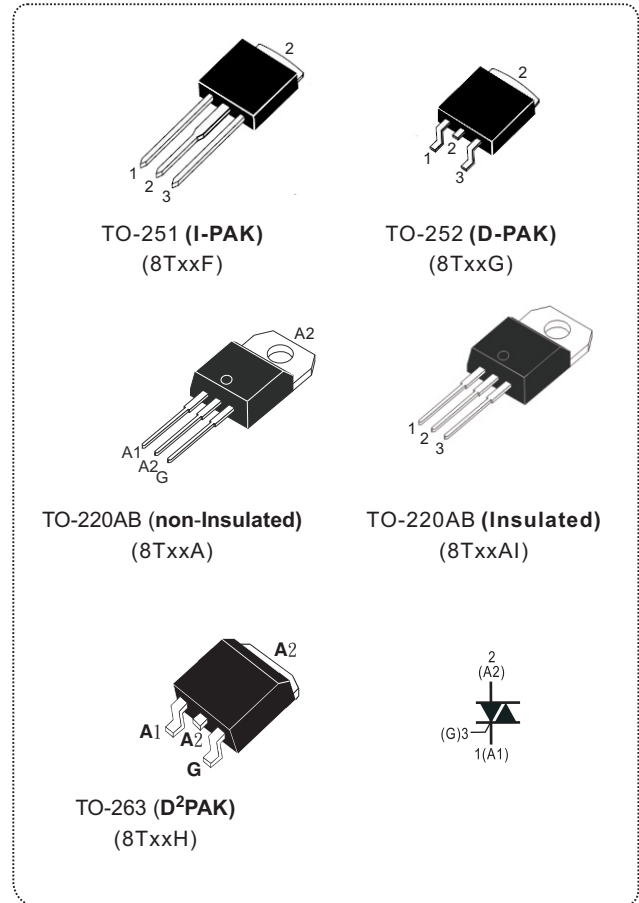

ABSOLUTE MAXIMUM RATINGS					
PARAMETER	SYMBOL	TEST CONDITIONS		VALUE	UNIT
RMS on-state current (full sine wave)	$I_{T(RMS)}$	TO-251/TO-252/TO-263/TO-220AB	$T_c = 110^\circ\text{C}$	8	A
		TO-220AB insulated	$T_c = 100^\circ\text{C}$		
Non repetitive surge peak on-state current (full cycle, T_j initial = 25°C)	I_{TSM}	F = 50 Hz	t = 20 ms	80	A
		F = 60 Hz	t = 16.7 ms	84	
I^2t Value for fusing	I^2t	$t_p = 10$ ms		32	A^2s
Critical rate of rise of on-state current $I_G = 2xI_{GT}$, $t_r \leq 100\text{ns}$	di/dt	F = 100 Hz	$T_j = 125^\circ\text{C}$	50	$\text{A}/\mu\text{s}$
Peak gate current	I_{GM}	$T_p = 20 \mu\text{s}$	$T_j = 125^\circ\text{C}$	4	A
Average gate power dissipation	$P_{G(AV)}$	$T_j = 125^\circ\text{C}$		1	W
Storage temperature range	T_{stg}			- 40 to + 150	°C
Operating junction temperature range	T_j			- 40 to + 125	

© ELECTRICAL CHARACTERISTICS (T_j= 25 °C unless otherwise specified)

SNUBBERLESS and Logic level (3 quadrants)								
SYMBOL	TEST CONDITIONS	QUADRANT		8Txxxx				Unit
				TW	SW	CW	BW	
I _{GT} ⁽¹⁾	V _D = 12 V, R _L = 30Ω	I - II - III	MAX.	05	10	35	50	mA
V _{GT}		I - II - III	MAX.	1.3				V
V _{GD}	V _D = V _{DRM} , R _L = 3.3KΩ T _j = 125°C	I - II - III	MIN.	0.2				V
I _H ⁽²⁾	I _T = 100 mA		MAX.	10	15	40	60	mA
I _L	I _G = 1.2 I _{GT}	I - III	MAX.	15	20	50	70	mA
		II		25	35	60	80	
dV/dt ⁽²⁾	V _D = 67% V _{DRM} , gate open, T _j = 125°C		MIN.	20	40	400	1000	V/μs
(dI/dt) _c ⁽²⁾	(dV/dt) _c = 0.1 V/μs	T _j = 125°C	MIN.	3.5	5.4	-	-	A/ms
	(dV/dt) _c = 10 V/μs	T _j = 125°C		1.5	2.8	-	-	
	Without snubber	T _j = 125°C		-	-	4.5	7	

© ELECTRICAL CHARACTERISTICS (T_j= 25 °C unless otherwise specified)

Standard (4 quadrants)						
SYMBOL	TEST CONDITIONS	QUADRANT		8Txxxx		UNIT
				C	B	
I _{GT} ⁽¹⁾	V _D = 12 V, R _L = 30Ω	I - II - III	MAX.	25	50	mA
V _{GT}		IV		50	100	
V _{GD}	V _D = V _{DRM} , R _L = 3.3KΩ, T _j = 125°C	ALL		1.3		V
V _{GD}	V _D = V _{DRM} , R _L = 3.3KΩ, T _j = 125°C	ALL		0.2		V
I _H ⁽²⁾	I _T = 200 mA		MAX.	25	50	mA
I _L	I _G = 1.2 I _{GT}	I - III - IV	MAX.	35	50	mA
		II		60	80	
dV/dt ⁽²⁾	V _D = 67% V _{DRM} , gate open, T _j = 125°C		MIN.	200	400	V/μs
(dV/dt) _c ⁽²⁾	(dI/dt) _c = 3.5 A/ms, T _j = 125°C		MIN.	5	10	V/μs

STATIC CHARACTERISTICS					
SYMBOL	TEST CONDITIONS			VALUE	UNIT
V _{TM} ⁽²⁾	I _{TM} = 11 A, t _P = 380 μs	T _j = 25°C	MAX.	1.55	V
V _{I0} ⁽²⁾	Threshold voltage	T _j = 125°C	MAX.	0.85	V
R _d ⁽²⁾	Dynamic resistance	T _j = 125°C	MAX.	50	mΩ
I _{DRM} I _{RDM}	V _D = V _{DRM} V _R = V _{RRM}	T _j = 25°C	MAX.	5	μA
		T _j = 125°C		1	mA

Note 1: minimum I_{GT} is guaranteed at 5% of I_{GT} max.

Note 2: for both polarities of A2 referenced to A1.

THERMAL RESISTANCE					
SYMBOL				VALUE	UNIT
R _{th(j-c)}	Junction to case (AC)	TO-220AB, TO-251, TO-252, TO-263		1.6	°C/W
		TO-220AB Insulated		2.5	
R _{th(j-a)}	Junction to ambient	S = 1 cm ²	TO-263	45	°C/W
		S = 0.5 cm ²	TO-252	70	
		TO-220AB Insulated, TO-220AB		60	
		TO-251		100	

S = Copper surface under tab.

PRODUCT SELECTOR						
PART NUMBER	VOLTAGE (xx)			SENSITIVITY	TYPE	PACKAGE
	600 V	800 V	1000 V			
8TxxA-B/8TxxAI-B	V	V	V	50 mA	Standard	TO-220AB
8TxxA-BW/8TxxAI-BW	V	V	V	50 mA	Snubberless	TO-220AB
8TxxA-C/8TxxAI-C	V	V	V	25 mA	Standard	TO-220AB
8TxxA-CW/8TxxAI-CW	V	V	V	35 mA	Snubberless	TO-220AB
8TxxA-SW/8TxxAI-SW	V	V	V	10 mA	Logic level	TO-220AB
8TxxA-TW/8TxxAI-TW	V	V	V	5 mA	Logic level	TO-220AB
8TxxG-SW	V	V	V	10 mA	Logic level	DPAK
8TxxF-SW	V	V	V	10 mA	Logic level	IPAK
8TxxH-SW	V	V	V	10 mA	Logic level	D ² PAK
8TxxG-CW	V	V	V	35 mA	Snubberless	DPAK
8TxxH-CW	V	V	V	35 mA	Snubberless	D ² PAK
8TxxF-CW	V	V	V	35 mA	Snubberless	IPAK

AI: non insulated TO-220AB package

ORDERING INFORMATION					
ORDERING TYPE	MARKING	PACKAGE	WEIGHT	BASE Q'TY	DELIVERY MODE
8TxxA-yy	8TxxA-yy	TO-220AB	2.0g	50	Tube
8TxxAI-yy	8TxxAI-yy	TO-220AB (insulated)	2.3g	50	Tube
8TxxF-yy	8TxxF-yy	TO-251(I-PAK)	0.40g	80	Tube
8TxxG-yy	8TxxG-yy	TO-252(D-PAK)	0.38g	80	Tube
8TxxH-yy	8TxxH-yy	D ² PAK	2.0g	50	Tube

Note: xx = voltage, yy = sensitivity

ORDERING INFORMATION SCHEME

8 T 06 A - BW

Current

8 = 8A

Triac series

Voltage

06 = 600V

08 = 800V

10 = 1000V

Package type

A = TO-220AB (non-insulated)

AI = TO-220AB (insulated)

AF = TO-220F (ISOWAT TO-220AB, insulated)

F = TO-251 (I-PAK)

G = TO-252 (D-PAK)

H = TO-263 (D²PAK)

I_{GT} Sensitivity

B = 50mA Standard

BW = 50mA Snubberless

C = 25mA Standard

CW = 35mA Snubberless

SW = 10mA Logic Level

TW = 5mA Logic Level

Fig.1 Maximum power dissipation versus RMS on-state current (full cycle)

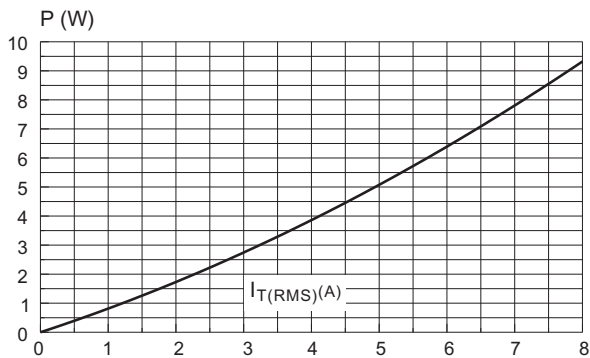

Fig.2 RMS on-state current versus case temperature (full cycle)

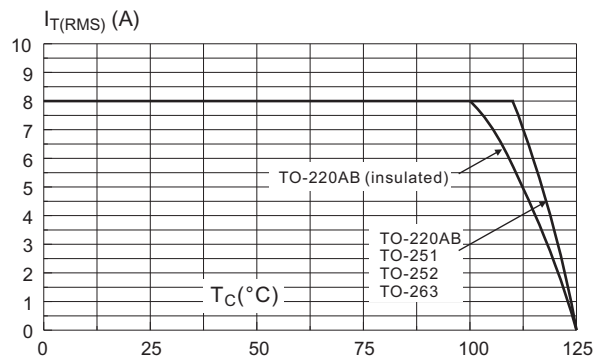

Fig.2-2 RMS on-state current versus ambient temperature (printed circuit board FR4, copper thickness: 35µm)

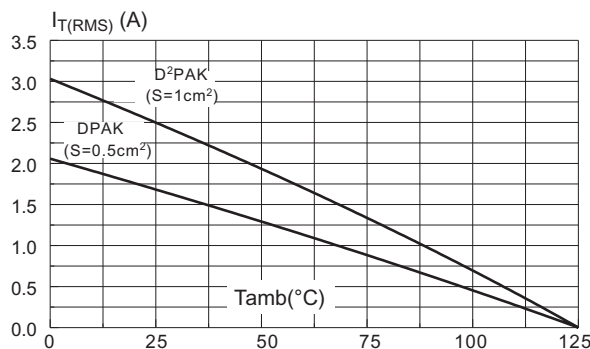

Fig.3 Relative variation of thermal impedance versus pulse duration.

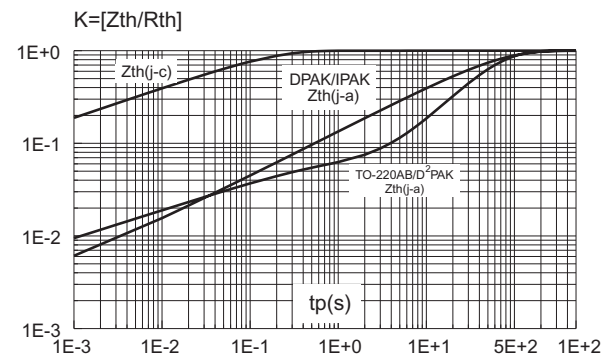

Fig.4 On-state characteristics (maximum values).

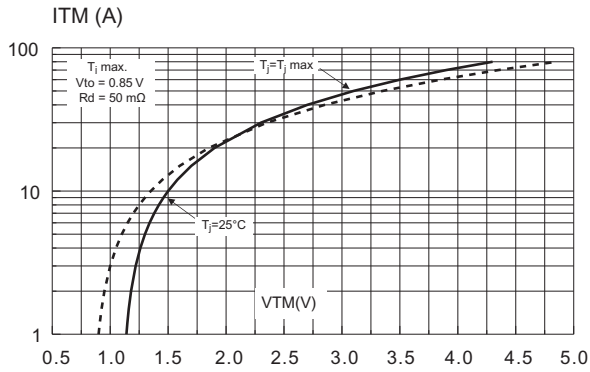

Fig.5 Surge peak on-state current versus number of cycles.

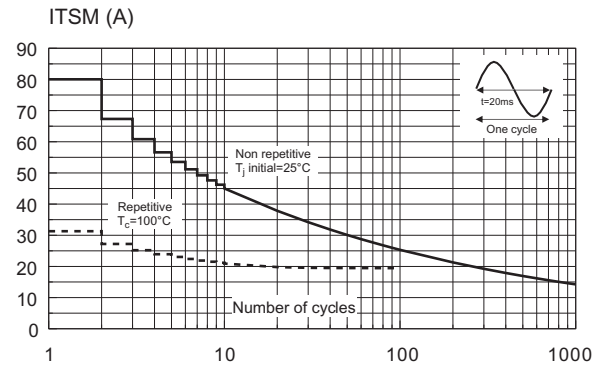

Fig.6 Non-repetitive surge peak on-state current for a sinusoidal pulse with width $t_p < 10\text{ms}$. and corresponding value of I^2t .

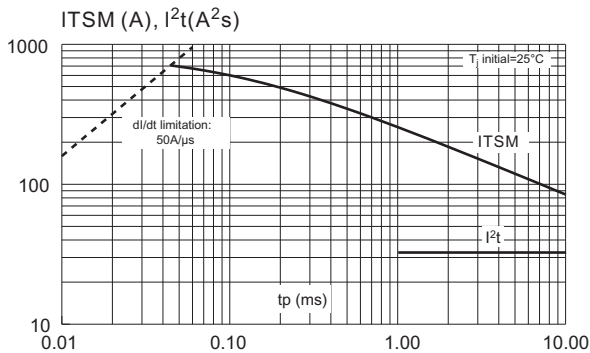

Fig.7 Relative variation of gate trigger current, holding current and latching current versus junction temperature (typical values).

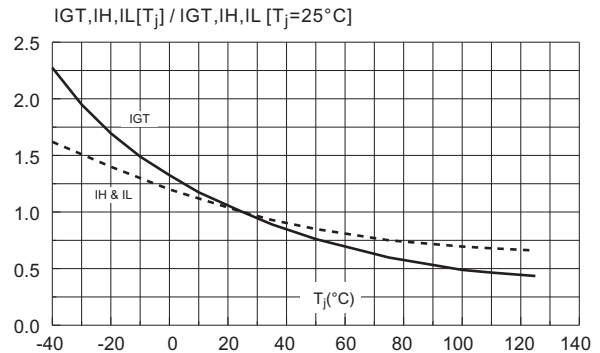

Fig.8-1 Relative variation of critical rate of decrease of main current versus $(dV/dt)_c$ (typical values). Snubberless & Logic Level Types

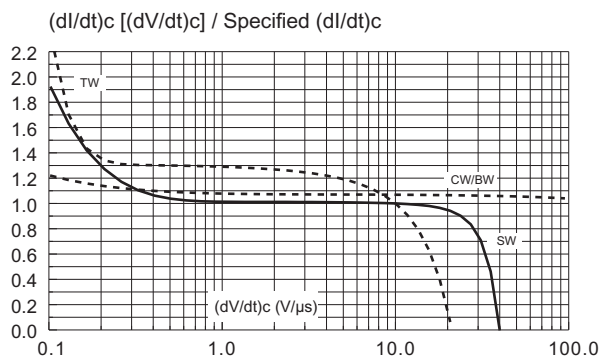

Fig.8-2 Relative variation of critical rate of decrease of main current versus $(dV/dt)_c$ (typical values). Standard Types

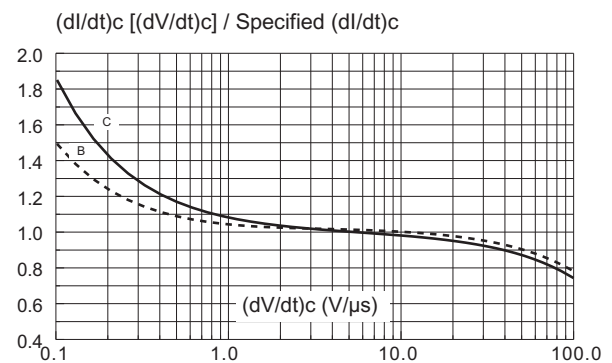

Fig.9 Relative variation of critical rate of decrease of main current versus junction temperature.

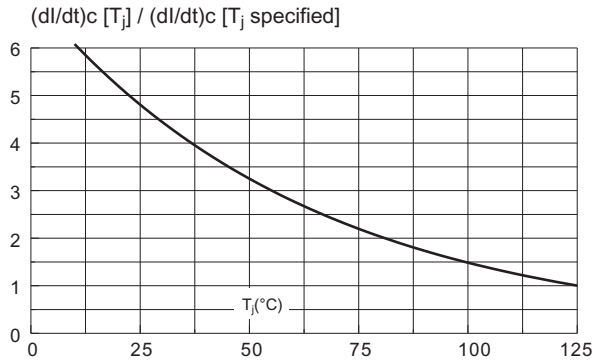
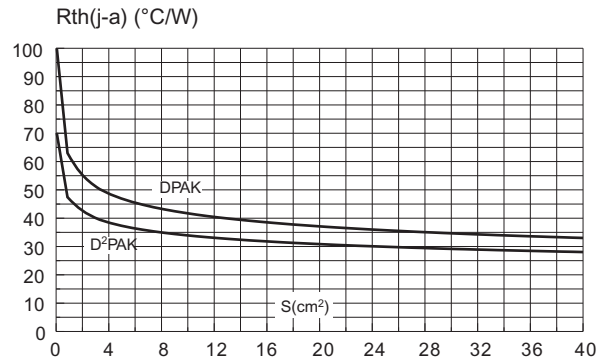
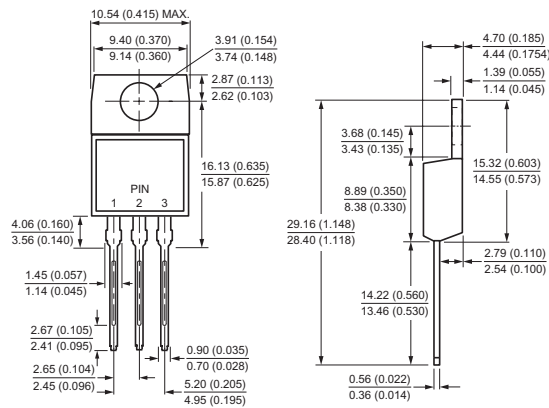

Fig.10 DPAK and D²PAK Thermal resistance junction to ambient versus copper surface under tab (printed circuit board Fr4, copper thickness: 35 μm.)



Case Style

TO-220AB



TO-263(D²PAK)

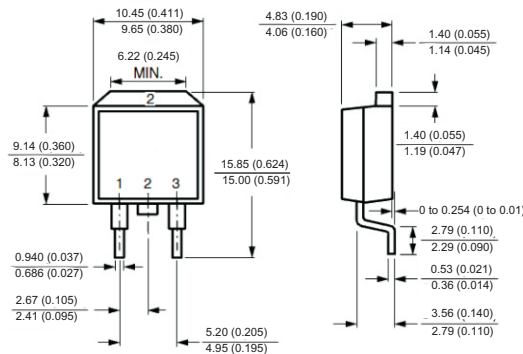

All dimensions in millimeters(inches)

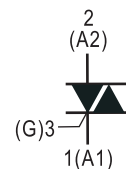

Case Style

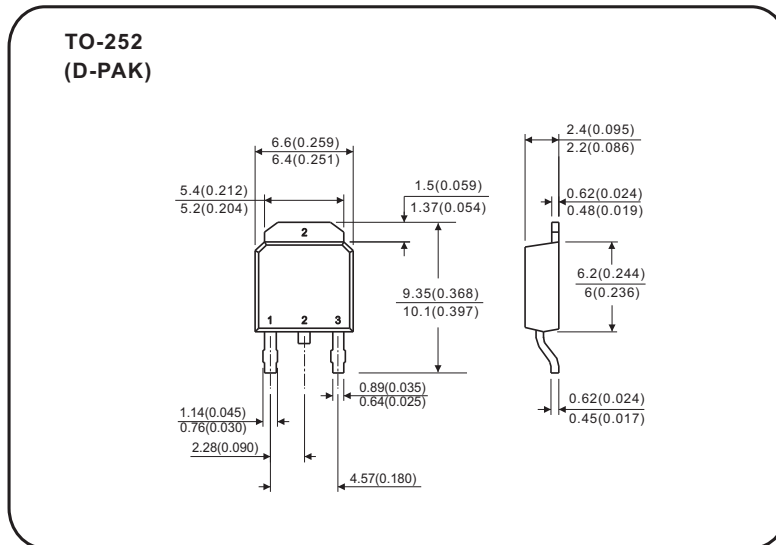
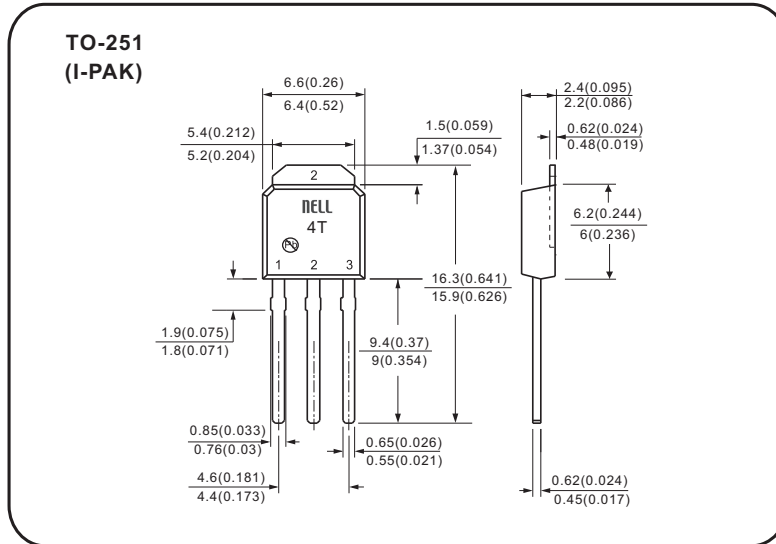

All dimensions in millimeters(inches)

