

Data sheet | Item number: 769-606/005-000

1-conductor male connector; CAGE CLAMP®; 4 mm²; Pin spacing 5 mm; 6-pole; Snap-in flange; 4,00 mm²; gray



www.wago.com/769-606/005-000



Color: —

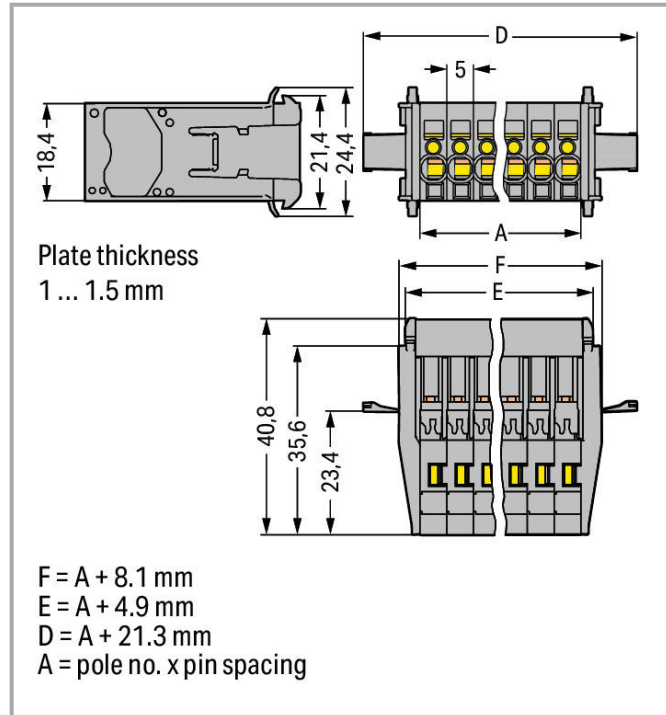

Data

Electrical data

Ratings per IEC/EN

Nominal voltage (III/3)	500 V
Rated surge voltage (III/3)	6 kV
Rated current	32 A
Legend (ratings)	(III / 3) $\hat{=}$ Overvoltage category III / Pollution degree 3

Connection data

Total number of connection points	6
Total number of potentials	6

Subject to changes. Please also observe the further product documentation!

WAGO GmbH & Co. KG
Hansastr. 27
32423 Minden
Phone: +49571 887-0 | Fax: +49571 887-169
Email: info.de@wago.com | Web: www.wago.com

Do you have any questions about our products?
We are always happy to take your call at +49 (571) 887-44222.

Connection 1

Connection technology	CAGE CLAMP®
Actuation type	Operating tool
Connectable conductor materials	Copper
Nominal cross-section	4 mm ²
Solid conductor	0.08 ... 4 mm ² / 28 ... 12 AWG
Fine-stranded conductor	0.08 ... 4 mm ² / 28 ... 12 AWG
Strip length	8 ... 9 mm / 0.31 ... 0.35 inch
Pole No.	6
Wiring direction	Front-entry wiring

Physical data

Pin spacing	5 mm / 0.197 inch
Width	51.3 mm / 2.02 inch
Height	24.4 mm / 0.961 inch
Depth	40.8 mm / 1.606 inch

Mechanical data

Variable coding	Ja
Mounting type	Snap-in

Plug-in connection

Contact type (pluggable connector)	Male connector/plug
Connector (connection type)	for conductor

Material data

Note on material data	Information on material data can be found here
Color	gray
Insulation material	Polyamide (PA66)
Flammability class per UL94	V0
Fire load	0.41 MJ
Weight	19.7 g



Subject to changes. Please also observe the further product documentation!

Commercial data



Product Group	18 (X-COM-System)
PU (SPU)	25 Stück
Packaging type	box
Country of origin	PL
GTIN	4044918840941
Customs tariff number	85366990990

Approvals / Certificates

Country specific Approvals

Logo	Approval	Additional Approval Text	Certificate name
	CCA DEKRA Certification B.V.	EN 61984	2190419.02
	CCA DEKRA Certification B.V.	IEC 61984	NL-47799 /A1
	CSA DEKRA Certification B.V.	C22.2 No. 158	1101144

UL-Approvals

Logo	Approval	Additional Approval Text	Certificate name
	UR Underwriters Laboratories Inc.	UL 1977	E45171
	UR Underwriters Laboratories Inc.	UL 1059	E45172

Optional accessories

Insulation stop

Insulation stop

Subject to changes. Please also observe the further product documentation!



Item no.: 769-470
Insulation stop; 0.08 - 0.2 mm² "s" (0.14 mm² "f-st"); 5 pieces/strip; white

www.wago.com/769-470



Item no.: 769-471
Insulation stop; 0.25 - 0.5 mm²; 5 pieces/strip; light gray

www.wago.com/769-471



Item no.: 769-472
Insulation stop; 0.75 - 1 mm²; 5 pieces/strip; dark gray

www.wago.com/769-472

Tool

Operating tool



Item no.: 210-490
Operating tool

www.wago.com/210-490



Item no.: 769-434
Push-button; loose

www.wago.com/769-434

Protective warning marker

Cover

Item no.: 280-415
Protective warning marker; for 5 terminal blocks; with high-voltage symbol, black; yellow

www.wago.com/280-415

Coding

Coding



Item no.: 769-435
Coding pin; for coding of female plugs; for carrier terminal blocks / male connectors; orange

www.wago.com/769-435

Ferrule

Ferrule



Item no.: 216-101
Ferrule; Sleeve for 0.5 mm² / AWG 22; uninsulated; electro-tin plated; silver-colored

www.wago.com/216-101



Item no.: 216-104
Ferrule; Sleeve for 1.5 mm² / AWG 16; uninsulated; electro-tin plated; silver-colored

www.wago.com/216-104



Item no.: 216-102
Ferrule; Sleeve for 0.75 mm² / AWG 20; uninsulated; electro-tin plated; silver-colored

www.wago.com/216-102



Item no.: 216-103
Ferrule; Sleeve for 1 mm² / AWG 18; uninsulated; electro-tin plated

www.wago.com/216-103



Item no.: 216-203
Ferrule; Sleeve for 1 mm² / AWG 18; insulated; electro-tin plated; red

www.wago.com/216-203



Item no.: 216-206
Ferrule; Sleeve for 2.5 mm² / AWG 14; insulated; electro-tin plated; blue

www.wago.com/216-206



Item no.: 216-202

Subject to changes. Please also observe the further product documentation!

Ferrule; Sleeve for 0.75 mm² / 18 AWG; insulated; electro-tin plated; gray

www.wago.com/216-202



Item no.: 216-204

Ferrule; Sleeve for 1.5 mm² / AWG 16; insulated; electro-tin plated; black

www.wago.com/216-204



Item no.: 216-201

Ferrule; Sleeve for 0.5 mm² / 20 AWG; insulated; electro-tin plated; white

www.wago.com/216-201

Marking accessories

Marking strip



Item no.: 210-831

Marking strips; on reel; 2.3 mm wide; plain; Self-adhesive; white

www.wago.com/210-831



Item no.: 210-833

Marking strips; 25 m on roll; 6 mm wide; plain; Self-adhesive; white

www.wago.com/210-833



Item no.: 210-834

Marking strips; on reel; 5 mm wide; plain; Self-adhesive; white

www.wago.com/210-834



Item no.: 210-832

Marking strips; on reel; 3 mm wide; plain; Self-adhesive; white

www.wago.com/210-832

Marker



Item no.: 248-501

Mini-WSB marking card; as card; not stretchable; plain; snap-on type; white

www.wago.com/248-501

Strain relief

Strain relief



Item no.: 769-413

Strain relief plate; gray

www.wago.com/769-413

Downloads

Documentation

Bid Text

769-606/005-000 X81 - Datei	2019. 2. 19.	xml 3.2 kB	Download
769-606/005-000 doc - Datei	2017. 10. 4.	doc 25.6 kB	Download

Additional Information

Technical Section Technical explanations		pdf 2.2 MB	Download
---	--	---------------	----------

Subject to changes. Please also observe the further product documentation!



CAD/CAE-Data

CAD data

2D/3D Models 769-606/005-000	URL	Download
------------------------------	---------------------	--------------------------

CAE data

EPLAN Data Portal 769-606/005-000	URL	Download
-----------------------------------	---------------------	--------------------------

WSCAD Universe 769-606/005-000	URL	Download
--------------------------------	---------------------	--------------------------

ZUKEN Portal 769-606/005-000	URL	Download
------------------------------	---------------------	--------------------------

WSCAD Universe 769-606/005-000	URL	Download
--------------------------------	---------------------	--------------------------

EPLAN Data Portal 769-606/005-000	URL	Download
-----------------------------------	---------------------	--------------------------

Environmental Product Compliance

Compliance Search

Environmental Product Compliance 769-606/005-000	URL	Download
--	---------------------	--------------------------

1-conductor male connector; CAGE CLAMP®; 4 mm²; Pin spacing 5 mm; 6-pole; Snap-in flange; 4,00 mm²; gray

Installation Notes

Installation

Subject to changes. Please also observe the further product documentation!

WAGO GmbH & Co. KG
Hansastr. 27
32423 Minden
Phone: +49571 887-0 | Fax: +49571 887-169
Email: info.de@wago.com | Web: www.wago.com

Do you have any questions about our products?
We are always happy to take your call at +49 (571) 887-44222.



Insert a male connector with snap-in flanges (769-604/005-000) into the cutout.



Male connector with snap-in flanges

Tool-free assembly



Tool-free assembly



Cutout

Male connectors with CAGE CLAMP® connection (769-6xx/005-000) and snap-in flanges

Conductor termination

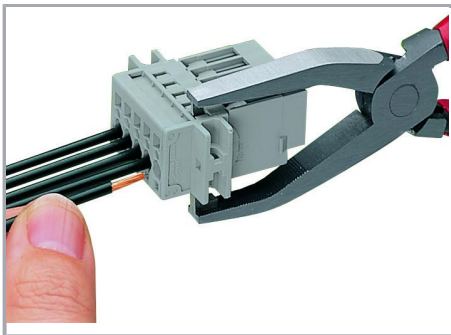

Operating tool

Inserting a conductor via operating tool (example shows a male connector).

Subject to changes. Please also observe the further product documentation!

Marking

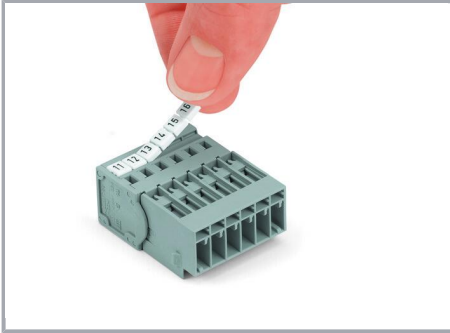

Labeling a male connector with CAGE
CLAMP® connection via Mini-WSB Quick
Markers.

Product family

X-COM

[Show all products from the family](#)

Subject to changes. Please also observe the further product documentation!