



**HE8051**

**NPN SILICON TRANSISTOR**

**LOW VOLTAGE HIGH CURRENT  
SMALL SIGNAL NPN  
TRANSISTOR**

■ **DESCRIPTION**

The UTC **HE8051** is a low voltage high current small signal NPN transistor, designed for Class B push-pull 2W audio amplifier for portable radio and general purpose applications.

■ **FEATURES**

- \* Collector current up to 1.5A
- \* Collector-Emitter voltage up to 25 V
- \* complimentary to UTC **HE8551**

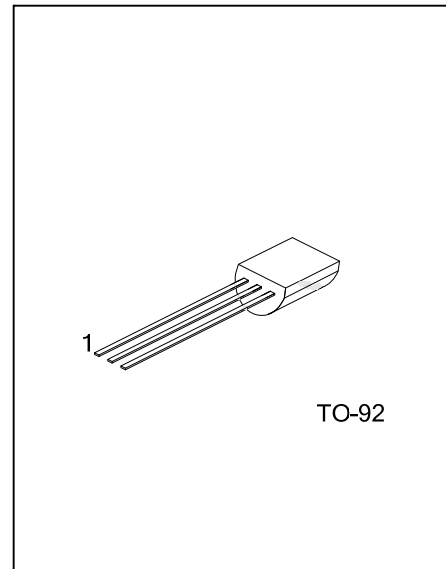

■ **ORDERING INFORMATION**

Order Number		Package	Pin Assignment			Packing
Lead Free	Halogen Free		1	2	3	
HE8051L-x-T92-B	HE8051G-x-T92-B	TO-92	E	B	C	Tape Box
HE8051L-x-T92-K	HE8051G-x-T92-K	TO-92	E	B	C	Bulk

<p>HE8051L-x-T92-B</p>	<p>(1) B: Tape Box, K: Bulk</p> <p>(2) T92: TO-92</p> <p>(3) x: refer to Classification of <math>h_{FE2}</math></p> <p>(4) L: Lead Free, G: Halogen Free</p>
------------------------	--

■ **MARKING**

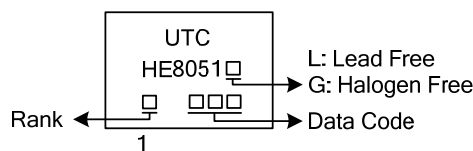

■ ABSOLUTE MAXIMUM RATINGS ( $T_A=25^\circ\text{C}$ , unless otherwise specified)

PARAMETER	SYMBOL	RATINGS	UNIT
Collector-Base Voltage	$V_{CBO}$	40	V
Collector-Emitter Voltage	$V_{CEO}$	25	V
Emitter-Base Voltage	$V_{EBO}$	6	V
Collector Dissipation ( $T_A=25^\circ\text{C}$ )	$P_C$	1	W
Collector Current	$I_C$	1.5	A
Junction Temperature	$T_J$	+150	$^\circ\text{C}$
Storage Temperature	$T_{STG}$	-40 ~ +150	$^\circ\text{C}$

Note: Absolute maximum ratings are those values beyond which the device could be permanently damaged. Absolute maximum ratings are stress ratings only and functional device operation is not implied.

■ ELECTRICAL CHARACTERISTICS ( $T_A=25^\circ\text{C}$ , unless otherwise specified)

PARAMETER	SYMBOL	TEST CONDITIONS	MIN	TYP	MAX	UNIT
Collector-Base Breakdown Voltage	$BV_{CBO}$	$I_C=100\mu\text{A}$ , $I_E=0$	40			V
Collector-Emitter Breakdown Voltage	$BV_{CEO}$	$I_C=2\text{mA}$ , $I_B=0$	25			V
Emitter-Base Breakdown Voltage	$BV_{EBO}$	$I_E=100\mu\text{A}$ , $I_C=0$	6			V
Collector Cut-Off Current	$I_{CBO}$	$V_{CB}=35\text{V}$ , $I_E=0$			100	nA
Emitter Cut-Off Current	$I_{EBO}$	$V_{EB}=6\text{V}$ , $I_C=0$			100	nA
DC Current Gain	$h_{FE1}$	$V_{CE}=1\text{V}$ , $I_C=5\text{mA}$	45	135		
	$h_{FE2}$	$V_{CE}=1\text{V}$ , $I_C=100\text{mA}$	85	160	500	
	$h_{FE3}$	$V_{CE}=1\text{V}$ , $I_C=800\text{mA}$	40	110		
Collector-Emitter Saturation Voltage	$V_{CE(SAT)}$	$I_C=800\text{mA}$ , $I_B=80\text{mA}$			0.5	V
Base-Emitter Saturation Voltage	$V_{BE(SAT)}$	$I_C=800\text{mA}$ , $I_B=80\text{mA}$			1.2	V
Base-Emitter Voltage	$V_{BE}$	$V_{CE}=1\text{V}$ , $I_C=10\text{mA}$			1.0	V
Current Gain Bandwidth Product	$f_T$	$V_{CE}=10\text{V}$ , $I_C=50\text{mA}$	100			MHz
Output Capacitance	$C_{ob}$	$V_{CB}=10\text{V}$ , $I_E=0$ , $f=1\text{MHz}$		9.0		pF

■ CLASSIFICATION OF  $h_{FE2}$

RANK	C	D	E
RANGE	120-200	160-300	250-500

■ TYPICAL CHARACTERISTICS

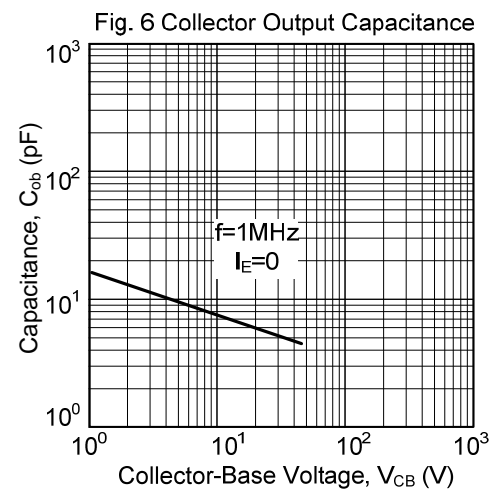
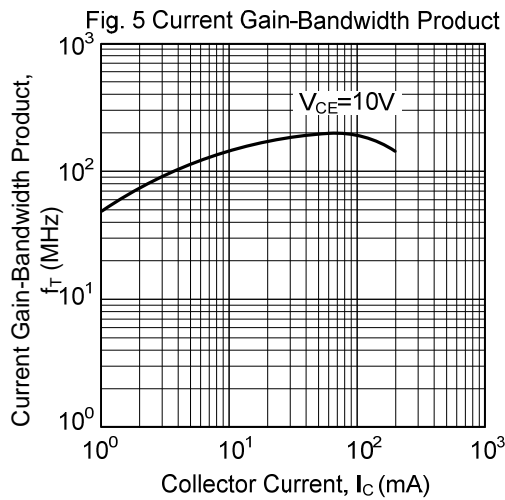
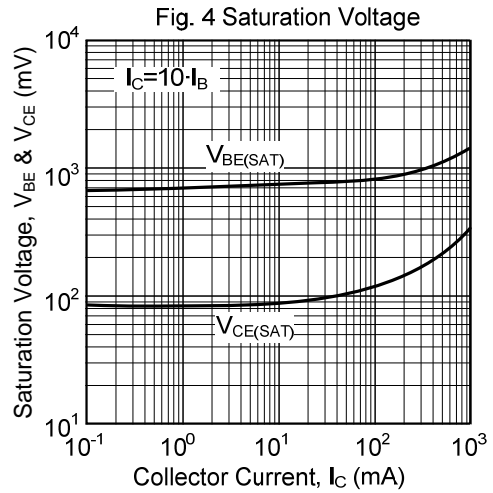
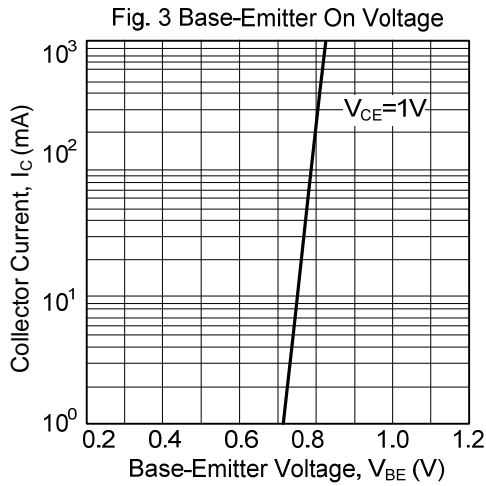
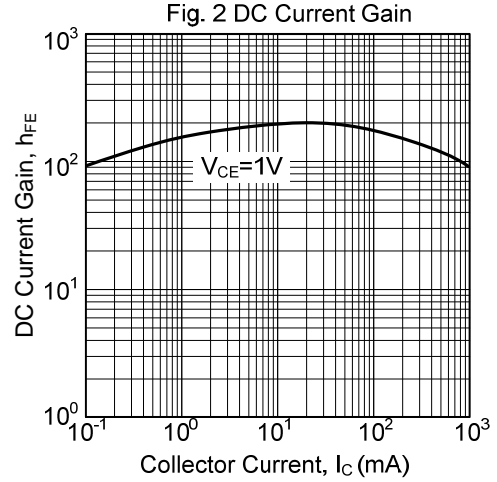
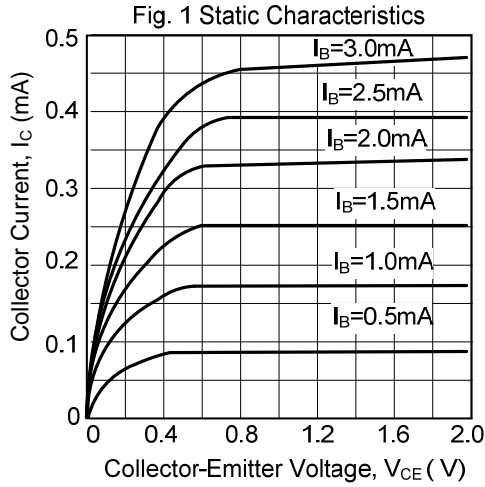

UTC assumes no responsibility for equipment failures that result from using products at values that exceed, even momentarily, rated values (such as maximum ratings, operating condition ranges, or other parameters) listed in products specifications of any and all UTC products described or contained herein. UTC products are not designed for use in life support appliances, devices or systems where malfunction of these products can be reasonably expected to result in personal injury. Reproduction in whole or in part is prohibited without the prior written consent of the copyright owner. The information presented in this document does not form part of any quotation or contract, is believed to be accurate and reliable and may be changed without notice.