

$V_{(BR)DSS}$	$R_{DS(on)MAX}$	I_D
50V	3.5Ω@ 10V	0.22A
	6.0Ω@4.5V	

Features

- 1) Low on-resistance.
- 2) Fast switching speed.
- 3) Drive circuits can be simple.
- 4) Parallel use is easy.
- 5) ESD protected 2KV HBM

Applications

Interfacing, switching (50V, 100mA)

ORDERING INFORMATION

Type No.	Marking	Package Code
BSS138	SS/J1	SOT-23

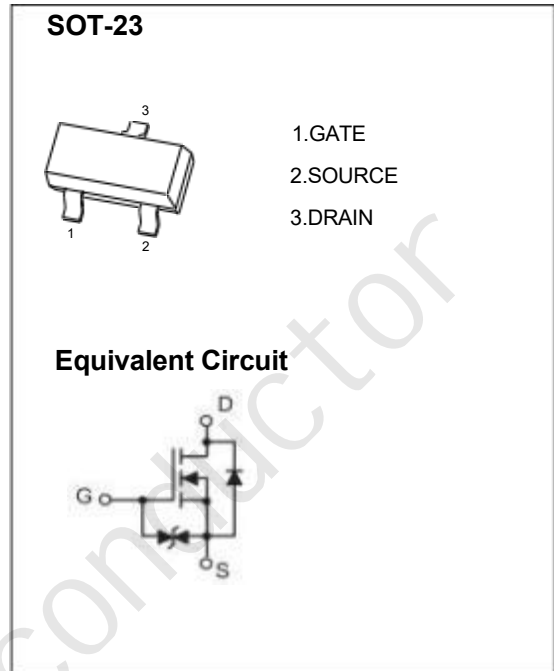
Absolute Maximum Ratings $T_A=25^{\circ}C$ unless otherwise noted

Symbol	Parameter	Ratings	Units
V_{DSS}	Drain-Source Voltage	50	V
V_{GSS}	Gate-Source Voltage	±20	V
I_D	Drain Current – Continuous (Note 1)	0.22	A
	– Pulsed	0.88	
P_D	Maximum Power Dissipation (Note 1)	0.36	W
	Derate Above 25°C	2.8	mW/°C
T_J, T_{STG}	Operating and Storage Junction Temperature Range	-55 to +150	°C
T_L	Maximum Lead Temperature for Soldering Purposes 1/16" from Case for 10 Seconds	300	°C

Thermal Characteristics

$R_{\theta JA}$	Thermal Resistance, Junction-to-Ambient (Note 1)	350	°C/W
-----------------	--	-----	------

Package Marking and Ordering Information

Device Marking	Device	Reel Size	Tape width	Quantity
SS	BSS138	7"	8mm	3000 units

$T_A = 25^\circ\text{C}$ unless otherwise noted

Symbol	Parameter	Test Conditions	Min	Typ	Max	Units
Off Characteristics						
BV_{DSS}	Drain–Source Breakdown Voltage	$V_{GS} = 0\text{ V}, I_D = 250\ \mu\text{A}$	50			V
$\frac{\Delta BV_{DSS}}{\Delta T_J}$	Breakdown Voltage Temperature Coefficient	$I_D = 250\ \mu\text{A}$, Referenced to 25°C		72		$\text{mV}/^\circ\text{C}$
I_{DSS}	Zero Gate Voltage Drain Current	$V_{DS} = 50\text{ V}, V_{GS} = 0\text{ V}$			0.5	μA
		$V_{DS} = 30\text{ V}, V_{GS} = 0\text{ V}$			100	nA
I_{GSS}	Gate–Body Leakage.	$V_{GS} = \pm 20\text{ V}, V_{DS} = 0\text{ V}$			± 100	nA
On Characteristics (Note 2)						
$V_{GS(th)}$	Gate Threshold Voltage	$V_{DS} = V_{GS}, I_D = 1\text{ mA}$	0.8	1.3	1.6	V
$\frac{\Delta V_{GS(th)}}{\Delta T_J}$	Gate Threshold Voltage Temperature Coefficient	$I_D = 1\text{ mA}$, Referenced to 25°C		-2		$\text{mV}/^\circ\text{C}$
$R_{DS(on)}$	Static Drain–Source On–Resistance	$V_{GS} = 10\text{ V}, I_D = 0.22\text{ A}$			3.5	Ω
		$V_{GS} = 4.5\text{ V}, I_D = 0.22\text{ A}$			6.0	
$I_{D(on)}$	On–State Drain Current	$V_{GS} = 10\text{ V}, V_{DS} = 5\text{ V}$	0.2			A
g_{FS}	Forward Transconductance	$V_{DS} = 10\text{ V}, I_D = 0.22\text{ A}$	0.12			S
Dynamic Characteristics						
C_{iss}	Input Capacitance	$V_{DS} = 25\text{ V}, V_{GS} = 0\text{ V}, f = 1.0\text{ MHz}$		27		pF
C_{oss}	Output Capacitance			13		pF
C_{rss}	Reverse Transfer Capacitance			6		pF
R_G	Gate Resistance	$V_{GS} = 15\text{ mV}, f = 1.0\text{ MHz}$		9		Ω
Switching Characteristics (Note 2)						
$t_{d(on)}$	Turn–On Delay Time	$V_{DD} = 30\text{ V}, I_D = 0.29\text{ A}, V_{GS} = 10\text{ V}, R_{GEN} = 6\ \Omega$		2.5	5	ns
t_r	Turn–On Rise Time			9	18	ns
$t_{d(off)}$	Turn–Off Delay Time			20	36	ns
t_f	Turn–Off Fall Time			7	14	ns
Q_g	Total Gate Charge	$V_{DS} = 25\text{ V}, I_D = 0.22\text{ A}, V_{GS} = 10\text{ V}$		1.7	2.4	nC
Q_{gs}	Gate–Source Charge			0.1		nC
Q_{gd}	Gate–Drain Charge			0.4		nC
Drain–Source Diode Characteristics and Maximum Ratings						
I_S	Maximum Continuous Drain–Source Diode Forward Current				0.22	A
V_{SD}	Drain–Source Diode Forward Voltage	$V_{GS} = 0\text{ V}, I_S = 0.44\text{ A}$ (Note 2)		0.8	1.4	V

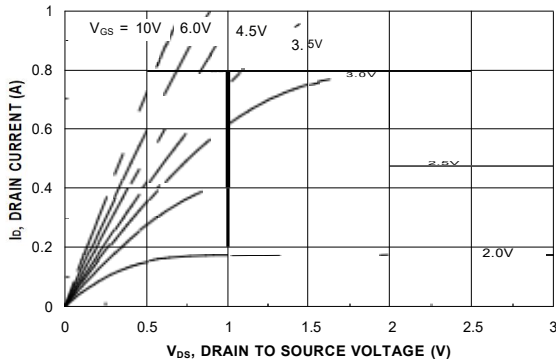
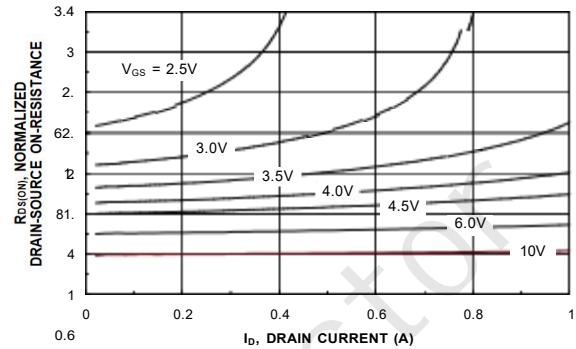
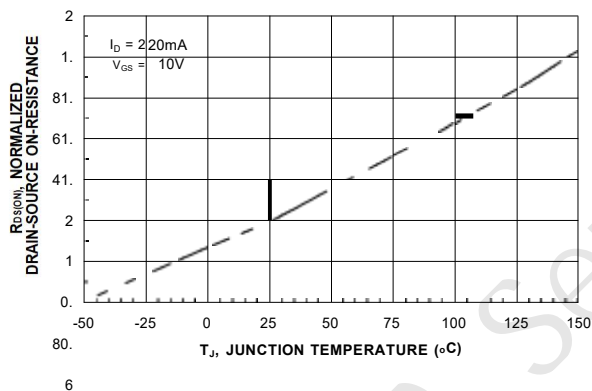
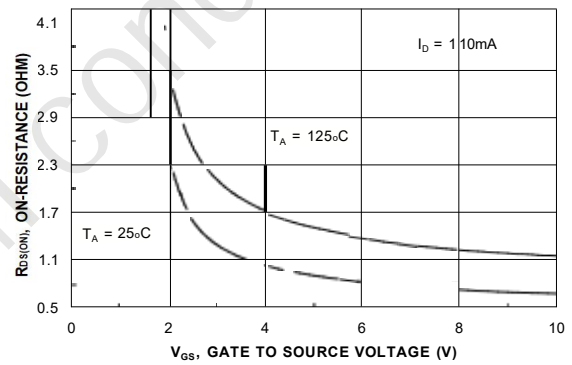
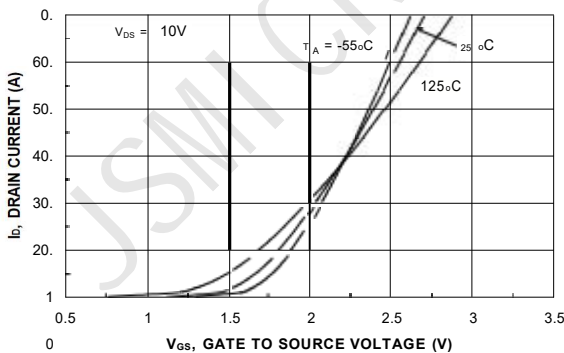
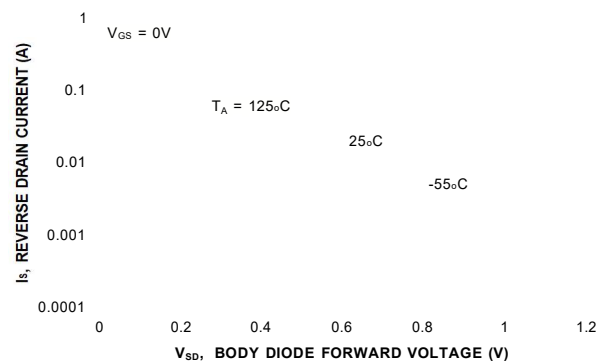
Typical Characteristics

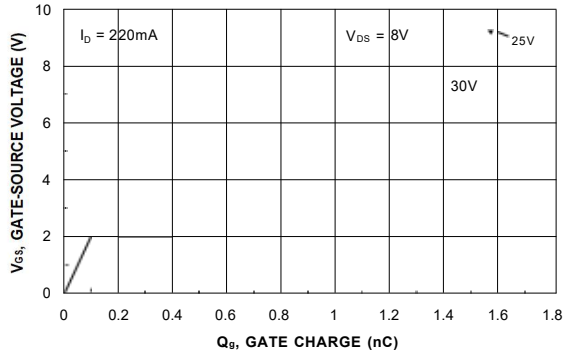
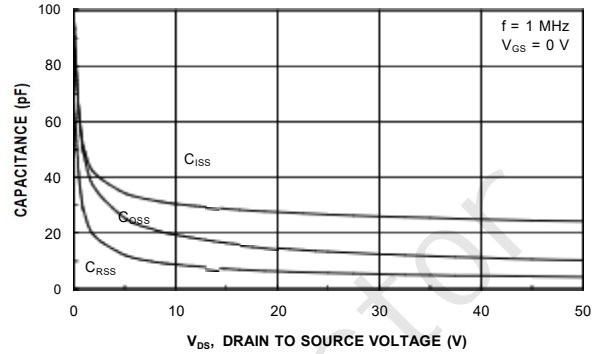
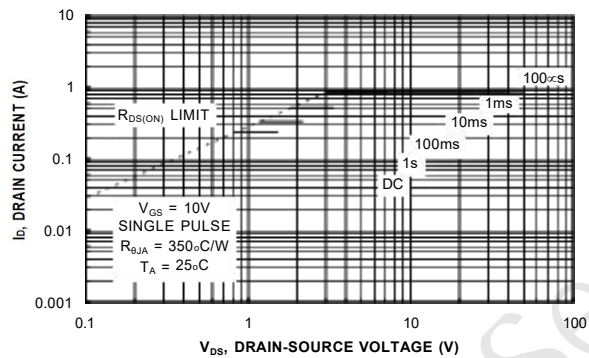
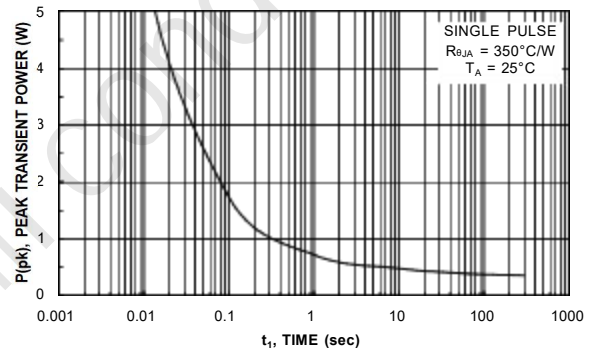
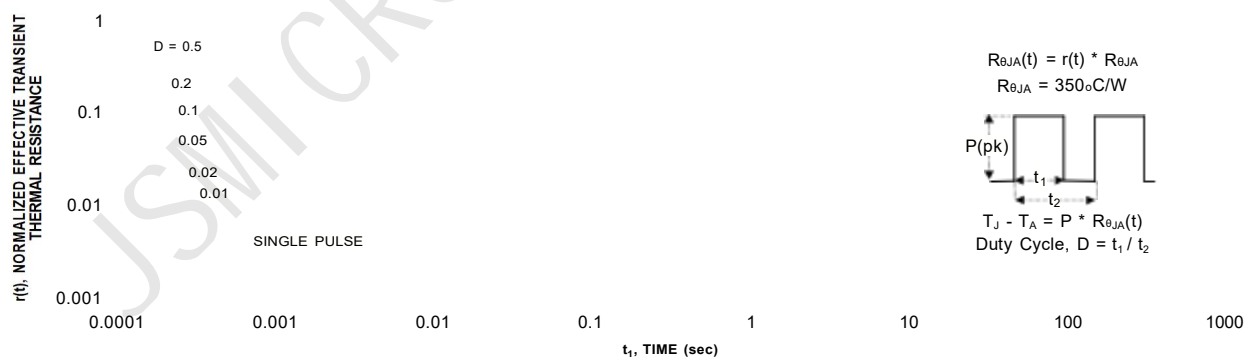
Figure 1. On-Region Characteristics.

Figure 2. On-Resistance Variation with Drain Current and Gate Voltage.

Figure 3. On-Resistance Variation with Temperature.

Figure 4. On-Resistance Variation with Gate-to-Source Voltage.

Figure 5. Transfer Characteristics.

Figure 6. Body Diode Forward Voltage Variation with Source Current and Temperature.

Typical Characteristics

Figure 7. Gate Charge Characteristics.

Figure 8. Capacitance Characteristics.

Figure 9. Maximum Safe Operating Area.

Figure 10. Single Pulse Maximum Power Dissipation.

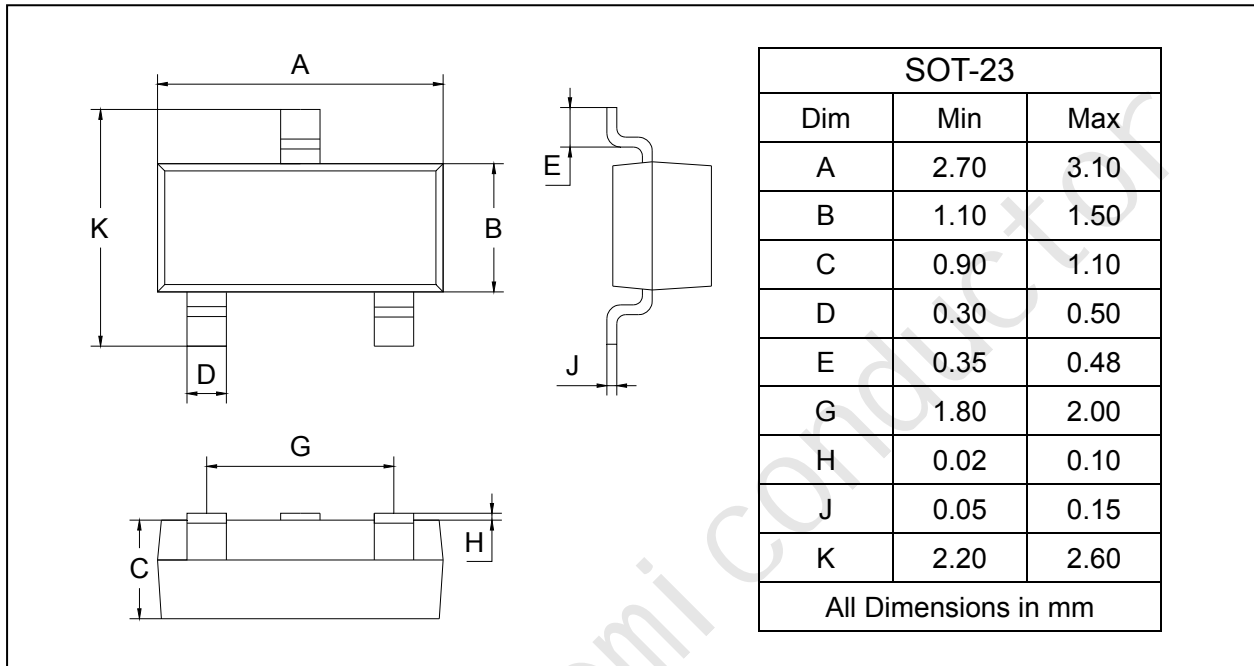
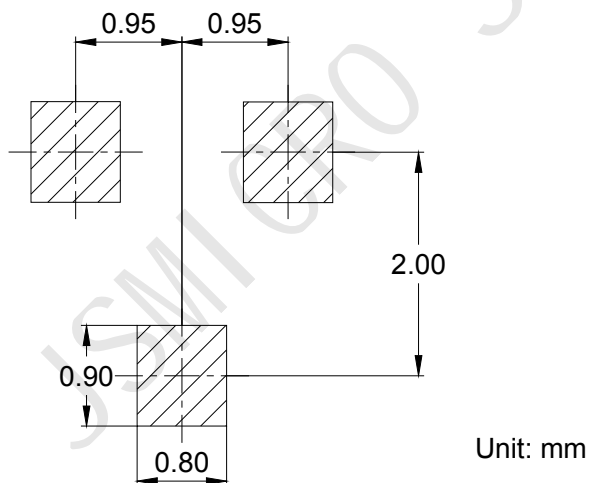
Figure 11. Transient Thermal Response Curve.

Thermal characterization performed using the conditions described in Note 1a.
 Transient thermal response will change depending on the circuit board design.

PACKAGE OUTLINE

Plastic surface mounted package

SOT-23

SOLDERING FOOTPRINT

PACKAGE INFORMATION

Device	Package	Shipping
BSS138	SOT-23	3000 pcs / Tape & Reel