

RoHS

CAD GENERATED DRAWING. DON'T CHANGE BY HAND.

REV.	ECN. NO.	APPD.

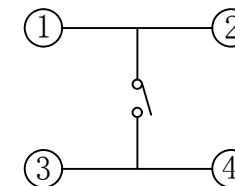
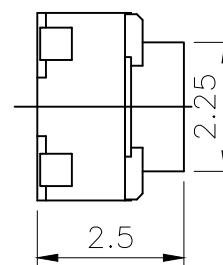
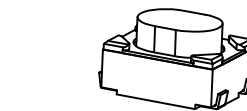
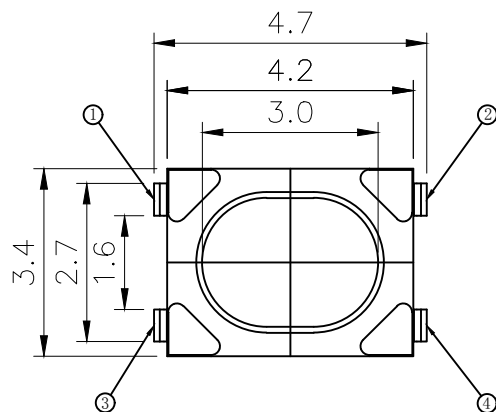
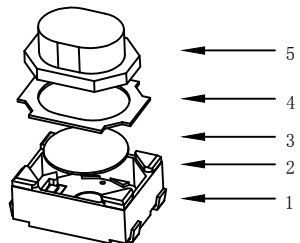

CIRCUIT DIAGRAM

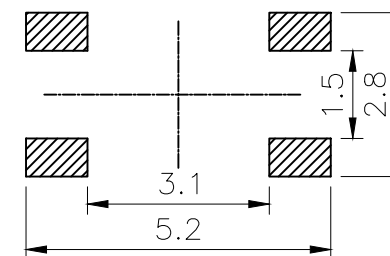

PCB. WELDING DRAWING

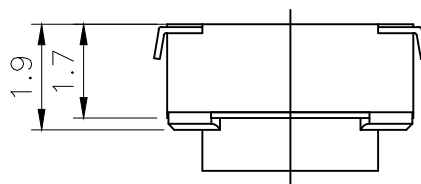

Specification

Rate voltage.current	50mA DC12V
Contact resistance	≤100mΩ
Operating force	600±50gf
Travel	0.20±0.10mm
Insulated resistance	≥100MΩ
Dielectric strength	≥250VAC/1min
Life cycle	≥100000次

5	Button	1	PPA	White
4	Cover	1	Phosphor copper	Copper tin plating
3	Shrapnel	1	Stainless steel	Silver
2	Housing	1	LCP	White
1	Cards	1	Phosphor copper	Silver
ITEM	PART NAME	Q' TY	MATERIAL	FINSH/COLOR

X.	±0.50	X. °	± 2°
.X	±0.30	.X°	± 1°
.XX	±0.10	.XX°	± 0.5°
.XXX	±0.05		

THESE DRAWINGS AND SPECIFICATIONS ARE THE PROPERTY OF YIYUAN TECHNOLOGY CO.,LTD AND SHALL NOT BE REPRODUCED, COPIED OR USED IN ANY MANNER WITHOUT THE PRIOR WRITTEN CONSENT OF YIYUAN TECHNOLOGY CO.,LTD

UNITS	mm	深圳市怡远科技有限公司 SHENZHEN YIYUAN TECHNOLOGY CO.,LTD
MAT'L	— / —	
FINISH	— / —	PART NO. YTS-A016-4
Q' TY	— / —	APPD: ROGER
		CHKD: ROC
		DR: BILLY WANG 2020/08/21
TITLE:		TACTILE SWITCH
DWG NO.:		YTS-A016-4
		SCALE SHEET REV.
		1/1 1/1 A1