

# T18-2 Epoxy Encapsulated Right-Angle Sensor

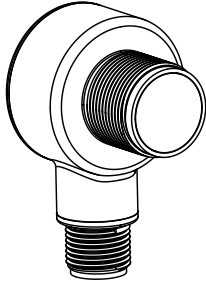

## Datasheet

Next Generation of Self-Contained dc-Operated Sensors



- Complete family of sensors, all housed in the compact right angle 18 mm threaded housing designed for long service life in wet environments
- ECO-Lab certified chemically robust epoxy encapsulated plastic sensors for wash-down applications typically found in the food and beverage industry
- Epoxy encapsulation of electronics provides a redundant seal in addition to plastic ultrasonic weld joints for maximum reliability in wet thermal shock environments
- Permanent laser etched product marking will not wear off after repeated cleaning cycles
- Food grade plastic materials used for all exposed surfaces
- Hygienic shape for easier cleaning of the sensor
- Powerful and bright visible red emitter beam for easy alignment and set-up
- Highly visible output and dual-function power and stability indicators
- Advanced ASIC technology makes sensor resistant to optical and electrical noise source
- Wide operating temperature range: -40 °C to +70 °C (-40 °F to +158 °F)



### WARNING: Not To Be Used for Personnel Protection

Never use this device as a sensing device for personnel protection. Doing so could lead to serious injury or death. This device does not include the self-checking redundant circuitry necessary to allow its use in personnel safety applications. A sensor failure or malfunction can cause either an energized or de-energized sensor output condition.

## Models

Integral 4-pin M12/Euro-style quick disconnect models are listed.

- To order the 2 m (6 ft) cable model, replace the suffix "-Q8" with "-2M".
- To order the 9 m (30 ft) cable model, replace the suffix "-Q8" with "-9M".

Models with a quick disconnect require a mating cordset.

Emitter/Receiver Models			
Model		Range	Output
T18-2NAEL-Q8	Emitter	25 m (82 ft)	None
T18-2NAEJ-Q8		25 m (82 ft) with beam inhibit	
T18-2NAES-Q8		25 m (82 ft) with adjustment	
T18-2VNRL-Q8	Receiver	25 m (82 ft)	Complementary NPN
T18-2VPRL-Q8			Complementary PNP
T18-2VNRS-Q8		25 m (82 ft) with adjustment	Complementary NPN
T18-2VPRS-Q8			Complementary PNP

Polarized Retroreflective Models		
Model	Range	Output
T18-2VNLP-Q8	6 m (19.7 ft) with BRT-84 reflector	Complementary NPN
T18-2VPLP-Q8		Complementary PNP
T18-2VNLPC-Q8	6 m (19.7 ft) with BRT-84 reflector, with adjustment	Complementary NPN
T18-2VPLPC-Q8		Complementary PNP



Diffuse Models		
Model	Range	Output
T18-2VNDL-Q8	750 mm (29.5 in) with adjustment	Complementary NPN
T18-2VPDL-Q8		Complementary PNP
T18-2VNDS-Q8	300 mm (11.8 in) with adjustment	Complementary NPN
T18-2VPDS-Q8		Complementary PNP

Fixed Field Models			
Models with Red Emitters	Models with Infrared Emitters	Range	Output
T18-2VNFF30-Q8	T18-2VNFF30IR-Q8	30 mm	Complementary NPN
T18-2VPFF30-Q8	T18-2VPFF30IR-Q8		Complementary PNP
T18-2VNFF50-Q8	T18-2VNFF50IR-Q8	50 mm	Complementary NPN
T18-2VPFF50-Q8	T18-2VPFF50IR-Q8		Complementary PNP
T18-2VNFF75-Q8	T18-2VNFF75IR-Q8	75 mm	Complementary NPN
T18-2VPFF75-Q8	T18-2VPFF75IR-Q8		Complementary PNP
T18-2VNFF100-Q8	T18-2VNFF100IR-Q8	100 mm	Complementary NPN
T18-2VPFF100-Q8	T18-2VPFF100IR-Q8		Complementary PNP
T18-2VNFF150-Q8	T18-2VNFF150IR-Q8	150 mm	Complementary NPN
T18-2VPFF150-Q8	T18-2VPFF150IR-Q8		Complementary PNP
T18-2VNFF200-Q8	T18-2VNFF200IR-Q8	200 mm	Complementary NPN
T18-2VPFF200-Q8	T18-2VPFF200IR-Q8		Complementary PNP

## Installing the T18-2 Epoxy Encapsulated Right-Angle Sensor

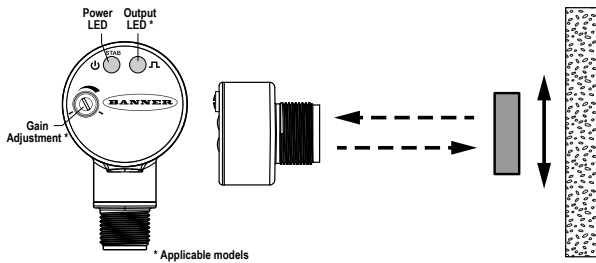

To install the T18-2 Epoxy Encapsulated Right-Angle Sensor:

1. Align the sensor as required for the application. For the most sensitive object detection, align the sensor so that the objects move across the sensor's axis.
2. Secure the sensor to a bracket.
3. Wire sensor as shown in the wiring diagrams.
4. Adjust the gain adjuster (sensitivity pot) if necessary.

## Wiring Diagrams

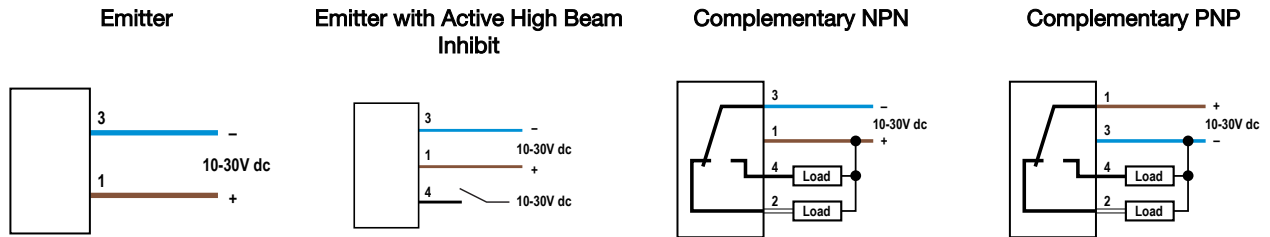

## Specifications

### Supply Voltage

10 V dc to 30 V dc for ambient temperature  $\leq 55\text{ }^{\circ}\text{C}$   
 10 V dc to 24 V dc for ambient temperature  $> 55\text{ }^{\circ}\text{C}$

### Supply Current (Exclusive of Load Current)

All models except FF IR:  $< 16\text{ mA}$   
 FF IR models:  $< 25\text{ mA}$

### Output Protection Circuitry

Protected against false pulse on power-up and continuous short circuit of outputs. Short circuit protection at elevated temperature may require a power cycle to reset.

### Supply Protection Circuitry

Protected against reverse polarity and transient voltages

### Output Rating

$\leq 50\text{ mA}$  total current for ambient temperatures  $> 55\text{ }^{\circ}\text{C}$   
 $\leq 100\text{ mA}$  total current through both outputs  $\leq 55\text{ }^{\circ}\text{C}$   
 OFF-State Leakage Current:  $< 50\text{ }\mu\text{A}$  at 30 V dc  
 ON-State Saturation Voltage:  $< 1.5\text{ V}$  at 10 mA;  $< 3.0\text{ V}$  at 100 mA

### Output Configuration

Complementary PNP or NPN by model number

### Emitter LED

Visible Red on most models  
 Infrared 850 nm on select fixed-field models to provide higher excess gain on blue and green targets

### Indicators

Two LEDs (1 green, 1 amber)  
 Green Solid: Indicates power applied and sensor ready  
 Green flashing: Indicates marginal sensing signal  
 Amber solid: Indicates Pin-4 (black wire) conducting

### Vibration and Mechanical Shock

All models meet Mil. Std. 202G requirements. Method 201A (Vibration; frequency 10 to 60 Hz, max., double amplitude 0.06 in acceleration 10G). Method 213B conditions H&I (Shock: 75G with unit operating; 100G for non-operation)

### Operating Conditions

$-40\text{ }^{\circ}\text{C}$  to  $+70\text{ }^{\circ}\text{C}$  ( $-40\text{ }^{\circ}\text{F}$  to  $+158\text{ }^{\circ}\text{F}$ )  
 95% at  $+50\text{ }^{\circ}\text{C}$  maximum relative humidity (non-condensing)

### Environmental Rating

IEC IP67 per IEC60529  
 IEC IP68 per IEC60529  
 DIN IP69K

### Certifications



Class 2 power

UL Environmental Rating: Type 1



Chemical compatibility certified

ECOLAB is a registered trademark of Ecolab USA Inc. All rights reserved.

### Output Response Time

Response is independent of signal strength  
 Opposed models: 1.5 milliseconds ON, 1 millisecond OFF  
 Polarized Retro, and Diffuse models: 1.5 milliseconds ON, 0.75 milliseconds OFF  
 Fixed Field models: 2 milliseconds ON, 2 milliseconds OFF  
 Delay on Power-up: 100 milliseconds; outputs do not conduct during this time

### Repeatability

Repeatability is independent of signal strength  
 Opposed models: 300 microseconds  
 Retro, Polarized Retro, and Diffuse models: 100 microseconds  
 Fixed Field models: 200 microseconds

### Adjustments

Diffuse (DL, DS), Emitter (ES), Receiver (RS), Polarized Retroreflective (LPC) models: Single turn sensitivity (gain) adjustment potentiometer  
 Emitter Beam Inhibit (EJ) models: Tie black wire to 10 to 30 V dc for beam inhibit

### Construction

Housing, M12 QD, and cover: Black or Yellow PBT polyester  
 Indicator light pipes: Translucent white PMMA (acrylic)  
 Indicator cover and gain pot driver: PBT polyester  
 Front window: PMMA

### Required Overcurrent Protection



**WARNING:** Electrical connections must be made by qualified personnel in accordance with local and national electrical codes and regulations.

Overcurrent protection is required to be provided by end product application per the supplied table.  
 Overcurrent protection may be provided with external fusing or via Current Limiting, Class 2 Power Supply.  
 Supply wiring leads  $< 24\text{ AWG}$  shall not be spliced.  
 For additional product support, go to [www.bannerengineering.com](http://www.bannerengineering.com).

Supply Wiring (AWG)	Required Overcurrent Protection (Amps)
20	5.0
22	3.0
24	2.0
26	1.0
28	0.8
30	0.5

Performance Curves

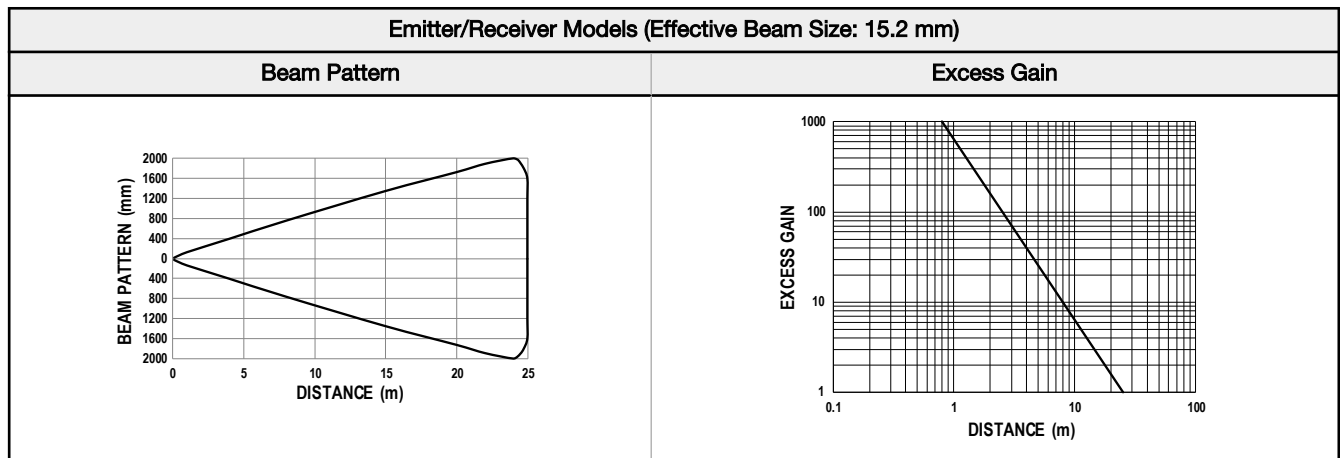
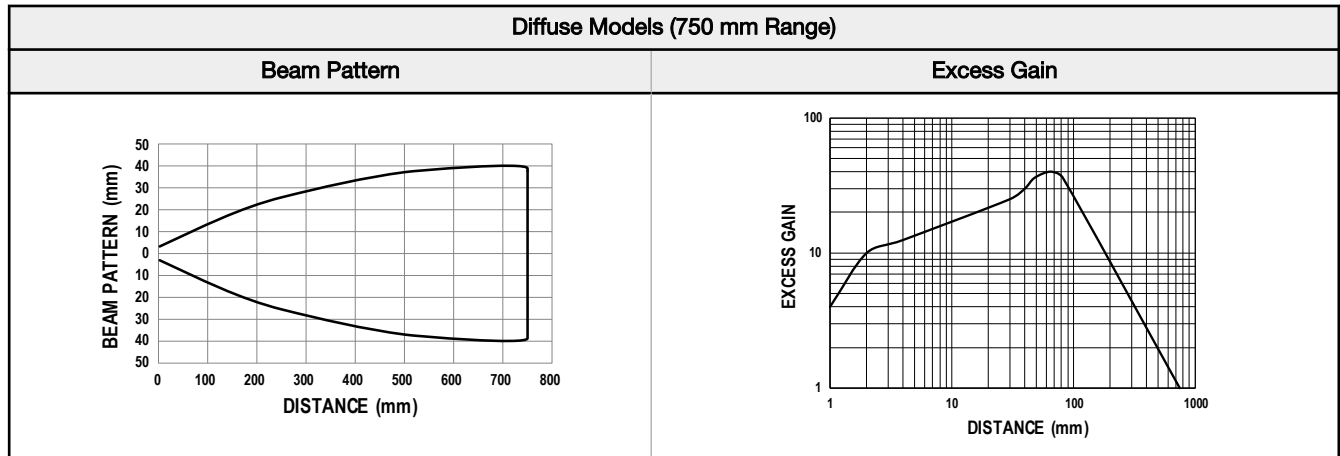
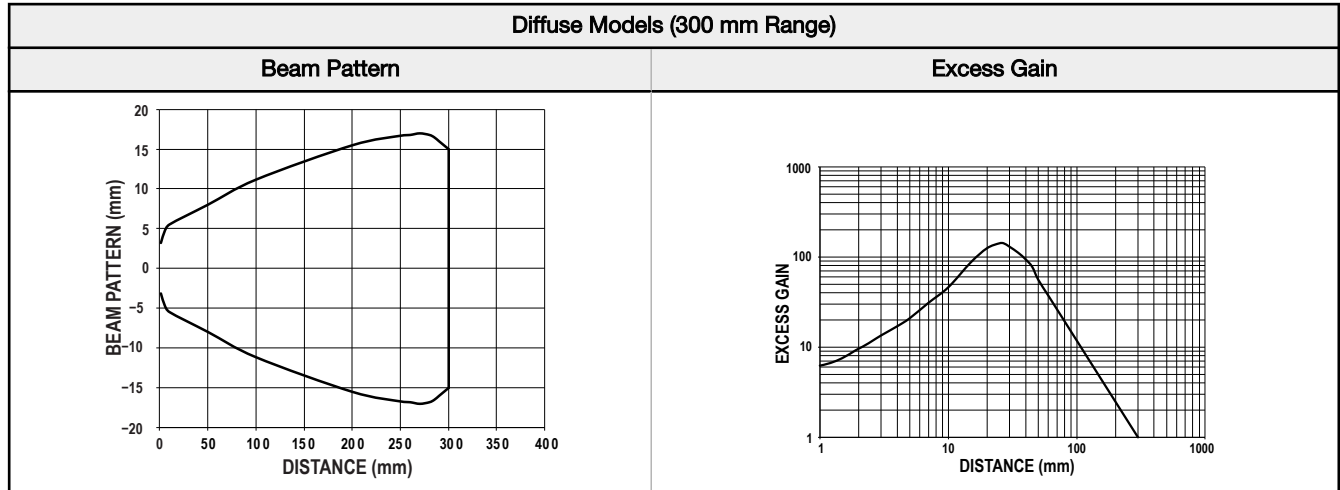

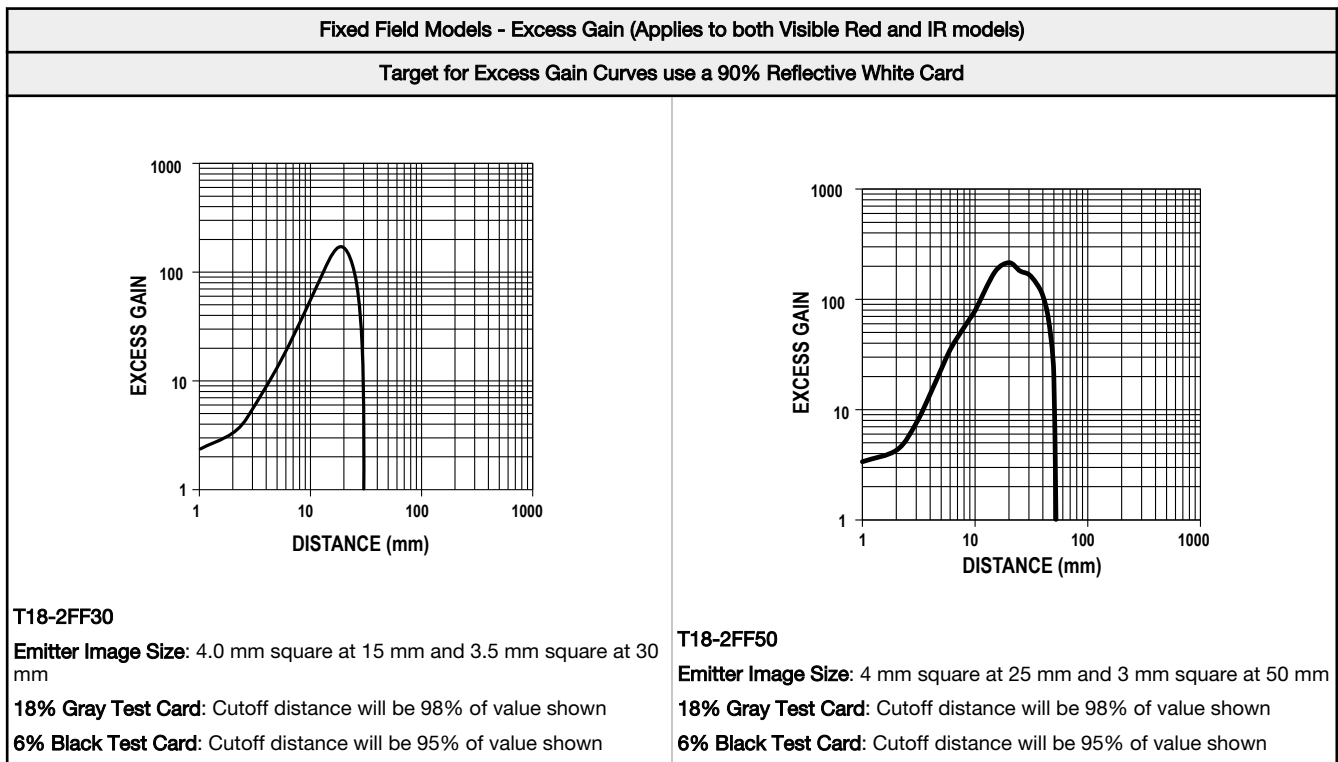
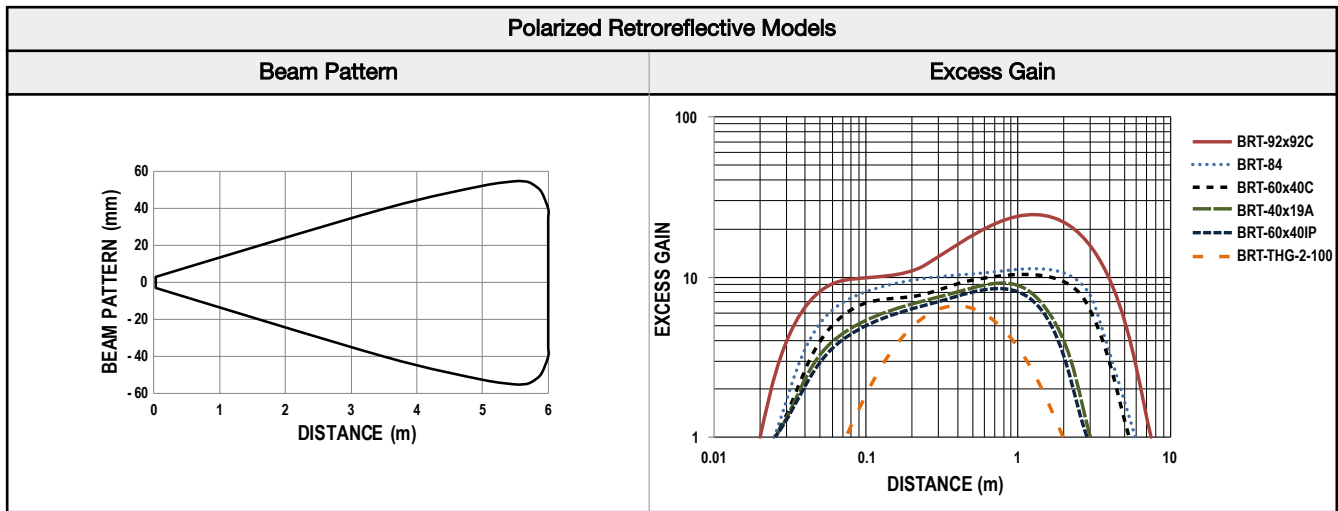

Fixed Field Models - Excess Gain (Applies to both Visible Red and IR models)	
Target for Excess Gain Curves use a 90% Reflective White Card	
<p><b>T18-2FF75</b>  <b>Emitter Image Size:</b> 4.5 mm square at 37 mm and 4.0 mm square at 75 mm  <b>18% Gray Test Card:</b> Cutoff distance will be 98% of value shown  <b>6% Black Test Card:</b> Cutoff distance will be 92% of value shown</p>	<p><b>T18-2FF100</b>  <b>Emitter Image Size:</b> 4.5 mm square at 50 mm and 4.5 mm square at 100 mm  <b>18% Gray Test Card:</b> Cutoff distance will be 95% of value shown  <b>6% Black Test Card:</b> Cutoff distance will be 90% of value shown</p>
<p><b>T18-2FF150</b>  <b>Emitter Image Size:</b> 5 mm square at 75 mm and 8 mm square at 150 mm  <b>18% Gray Test Card:</b> Cutoff distance will be 90% of value shown  <b>6% Black Test Card:</b> Cutoff distance will be 70% of value shown</p>	<p><b>T18-2FF200</b>  <b>Emitter Image Size:</b> 5 mm square at 100 mm and 8 mm square at 200 mm  <b>18% Gray Test Card:</b> Cutoff distance will be 85% of value shown  <b>6% Black Test Card:</b> Cutoff distance will be 60% of value shown</p>

Dimensions

All measurements are listed in millimeters [inches], unless noted otherwise.

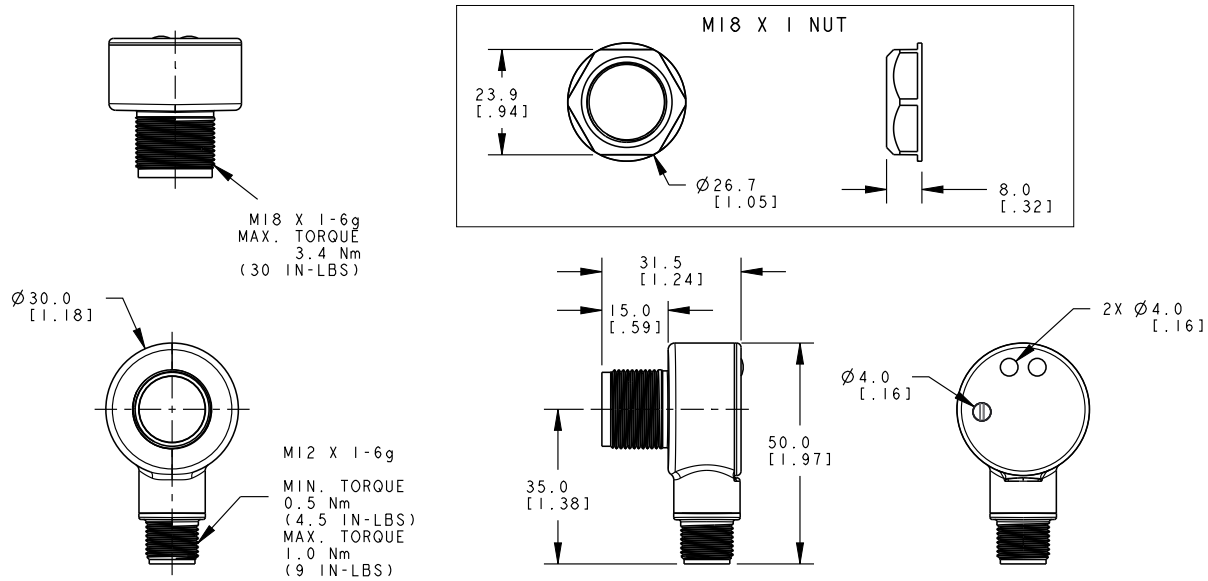

## Accessories

### Cordsets

All measurements are listed in millimeters, unless noted otherwise.

4-Pin Threaded M12/Euro-Style Cordsets—Washdown, Stainless Steel				
Model	Length	Style	Dimensions	Pinout (Female)
MQDC-WDSS-0406	1.83 m (6 ft)	Straight		<p>1 = Brown 2 = White 3 = Blue 4 = Black</p>
MQDC-WDSS-0415	4.57 m (15 ft)			
MQDC-WDSS-0430	9.14 m (30 ft)			

4-Pin Threaded M12/Euro-Style Cordsets				
Model	Length	Style	Dimensions	Pinout (Female)
MQDC-406	1.83 m (6 ft)	Straight		<p>1 = Brown 2 = White 3 = Blue 4 = Black</p>
MQDC-415	4.57 m (15 ft)			
MQDC-430	9.14 m (30 ft)			
MQDC-450	15.2 m (50 ft)	Right-Angle		<p>1 = Brown 2 = White 3 = Blue 4 = Black</p>
MQDC-406RA	1.83 m (6 ft)			
MQDC-415RA	4.57 m (15 ft)			
MQDC-430RA	9.14 m (30 ft)			
MQDC-450RA	15.2 m (50 ft)			

## Apertures

Model	Units	Aperture Description	Product
AP18SCN	3	Kit includes round apertures of 0.5 mm (0.02 in), 1.0 mm (0.04 in), and 2.5 mm (0.10 in) diameter.	
AP18SRN	3	Kit includes rectangular apertures of 0.5 mm (0.02 in), 1.0 mm (0.04 in), and 2.5 mm (0.10 in) wide. Each kit also includes a thread-on housing, Teflon® FEP® lens, and o-ring.	
APG18S	1	Kit with glass lens to protect plastic sensor lens from chemical environments and weld splatter damage.	

## Brackets

### SMB18A

- Right-angle mounting bracket with a curved slot for versatile orientation
- 12-ga. stainless steel
- 18 mm sensor mounting hole
- Clearance for M4 (#8) hardware

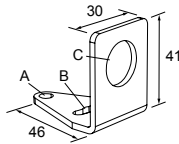

**Hole center spacing:** A to B = 24.2

**Hole size:** A =  $\varnothing$  4.6, B = 17.0 x 4.6, C =  $\varnothing$  18.5

### SMB18FA..

- Swivel bracket with tilt and pan movement for precision adjustment
- Easy sensor mounting to extruded rail T-slots
- Metric and inch size bolts available
- 18 mm sensor mounting hole

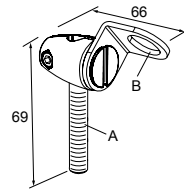

**Hole size:** B= $\varnothing$  18.1

Model	Bolt Thread (A)
SMB18FA	3/8 - 16 x 2 in
SMB18FAM10	M10 - 1.5 x 50
SMB18FAM12	n/a; no bolt included. Mounts directly to 12 mm (1/2 in) rods

### SMB18FA..-SS

- Swivel bracket with tilt and pan movement for precision adjustment
- Easy sensor mounting to extruded rail T-slots
- Stainless steel
- Metric and inch size bolts available
- 18 mm sensor mounting hole

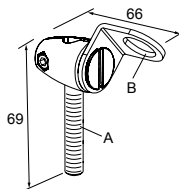

**Hole size:** B= $\varnothing$  18.1

Model	Bolt Thread (A)
SMB18FA-SS	3/8 - 16 x 2 in
SMB18FAM10-SS	M10 - 1.5 x 50
SMB18FAM12-SS	n/a; no bolt included. Mounts directly to 12 mm (1/2 in) rods

### ACC-T18-2-GSK-FDA-10 Gasket Kit

- FDA approved blue silicon
- 18 mm ID; 27 mm OD; 0.79 mm thick
- Quantity: 10

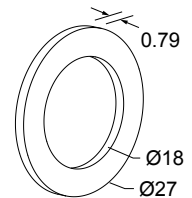

For additional brackets, check the current Banner catalog or visit [www.bannerengineering.com](http://www.bannerengineering.com). All measurements are listed in millimeters, unless noted otherwise.



## Reflectors

### BRT-2X2

- Square, acrylic target
- Reflectivity factor: 1.0
- Max. temperature: +50 °C (+122 °F)
- Optional brackets are available
- Approximate size: 51 mm x 51 mm

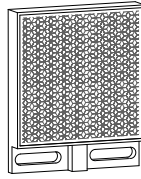

### BRT-84X84A

- Square, acrylic target
- Reflectivity Factor: 2.0
- Temperature: -20 °C to +60 °C (-4 °F to +140 °F)
- Approximate size: 84 mm x 84 mm

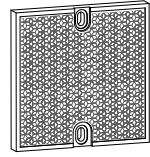

### BRT-40X19A

- Rectangular, acrylic target
- Reflectivity Factor: 1.3
- Temperature: -20 °C to +60 °C (-4 °F to +140 °F)
- Approximate size: 19 mm x 60 mm overall; 19 mm x 40 mm reflector

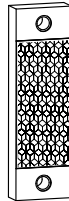

### BRT-60X40C

- Rectangular, acrylic target
- Reflectivity Factor: 1.4
- Temperature: -20 °C to +60 °C (-4 °F to +140 °F)
- Optional brackets are available
- Approximate size: 40 mm x 60 mm

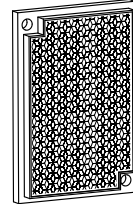

### BRT-60X40IP69K

- Rectangular, acrylic target (color is amber)
- Reflectivity Factor: 0.7
- Temperature: -20 °C to +140 °C (-4 °F to +284 °F)
- Chemically resistant
- IP69K washdown rated
- Optional brackets are available
- Approximate size: 40 mm x 60 mm

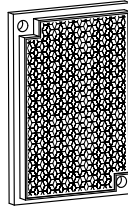

### BRT-60X40AF

- Rectangular, acrylic target
- Reflectivity Factor: 1.4
- Temperature: -20 °C to +60 °C (-4 °F to +140 °F)
- Anti-fogging coating for use around steam
- Optional brackets are available
- Approximate size: 40 mm x 60 mm

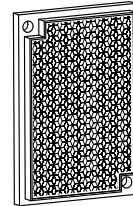

### BRT-84

- Round, acrylic target
- Reflectivity Factor: 1.4
- Temperature: -20 °C to +60 °C (-4 °F to +140 °F)
- Optional brackets are available
- Size: 84 mm diameter
- Mounting Hole: 4.5 mm diameter

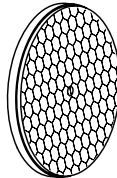

## Retroreflective Tape

Model	Reflectivity Factor	Maximum Temperature	Size
BRT-THG-2-100	0.7	+60 °C (+140 °F)	50 mm (2 in) wide, 2.5 m (100 in) long

## Banner Engineering Corp. Limited Warranty

---

Banner Engineering Corp. warrants its products to be free from defects in material and workmanship for one year following the date of shipment. Banner Engineering Corp. will repair or replace, free of charge, any product of its manufacture which, at the time it is returned to the factory, is found to have been defective during the warranty period. This warranty does not cover damage or liability for misuse, abuse, or the improper application or installation of the Banner product.

**THIS LIMITED WARRANTY IS EXCLUSIVE AND IN LIEU OF ALL OTHER WARRANTIES WHETHER EXPRESS OR IMPLIED (INCLUDING, WITHOUT LIMITATION, ANY WARRANTY OF MERCHANTABILITY OR FITNESS FOR A PARTICULAR PURPOSE), AND WHETHER ARISING UNDER COURSE OF PERFORMANCE, COURSE OF DEALING OR TRADE USAGE.**

This Warranty is exclusive and limited to repair or, at the discretion of Banner Engineering Corp., replacement. **IN NO EVENT SHALL BANNER ENGINEERING CORP. BE LIABLE TO BUYER OR ANY OTHER PERSON OR ENTITY FOR ANY EXTRA COSTS, EXPENSES, LOSSES, LOSS OF PROFITS, OR ANY INCIDENTAL, CONSEQUENTIAL OR SPECIAL DAMAGES RESULTING FROM ANY PRODUCT DEFECT OR FROM THE USE OR INABILITY TO USE THE PRODUCT, WHETHER ARISING IN CONTRACT OR WARRANTY, STATUTE, TORT, STRICT LIABILITY, NEGLIGENCE, OR OTHERWISE.**

Banner Engineering Corp. reserves the right to change, modify or improve the design of the product without assuming any obligations or liabilities relating to any product previously manufactured by Banner Engineering Corp. Any misuse, abuse, or improper application or installation of this product or use of the product for personal protection applications when the product is identified as not intended for such purposes will void the product warranty. Any modifications to this product without prior express approval by Banner Engineering Corp will void the product warranties. All specifications published in this document are subject to change; Banner reserves the right to modify product specifications or update documentation at any time. Specifications and product information in English supersede that which is provided in any other language. For the most recent version of any documentation, refer to: [www.bannerengineering.com](http://www.bannerengineering.com).

For patent information, see [www.bannerengineering.com/patents](http://www.bannerengineering.com/patents).