

FEATURES

- AC or Polarity Insensitive Inputs
- Continuous Forward Current, 130 mA
- Applications—Telecommunications
 - Ring Detection
 - Loop Current Detector
- Built-in Reverse Polarity Input Protection
- Improved CTR Symmetry
- Industry Standard DIP Package
- Underwriters Lab File #E52744
-  VDE Approval #0884 Applied For

DESCRIPTION

The IL255 is a bidirectional input optically coupled isolator consisting of two high current Gallium Arsenide infrared LEDs coupled to a silicon NPN phototransistor. The IL255 has a minimum CTR of 20%

This optocoupler is ideal for applications requiring AC signal detection and monitoring.

Maximum Ratings

Emitter

Peak Pulsed Current (1 μ s, 300 pps) 3 A
 Continuous Forward Current 130 mA RMS
 Power Dissipation at 25°C 175 mW
 Derate Linearly from 25°C 2.3 mW/°C

Detector

Collector-Emitter Breakdown Voltage 30 V
 Emitter-Base Breakdown Voltage 5 V
 Collector-Base Breakdown Voltage 70 V
 Power Dissipation at 25°C 200 mW
 Derate Linearly from 25°C 2.6 mW/°C

Package

Isolation Test Voltage 5300 VAC_{RMS}
 Between Emitter and Detector
 Refer to Standard Climate
 23°C/50%RH, DIN 50014
 Creepage min. 7 mm
 Clearance min. 7 mm
 Isolation Resistance
 $V_{IO}=500$ V, $T_A=25^\circ\text{C}$ $\geq 10^{12}$ Ω
 $V_{IO}=500$ V, $T_A=100^\circ\text{C}$ $\geq 10^{11}$ Ω
 Total Dissipation at 25°C 250 mW
 Derate Linearly from 25°C 3.3 mW/°C
 Storage Temperature -55°C to +150°C
 Operating Temperature -55°C to +100°C
 Lead Soldering Time at 260°C 10 sec.

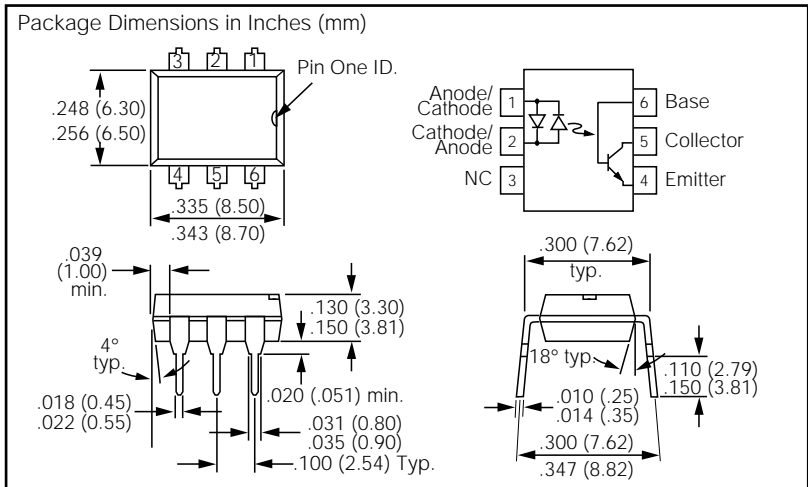

Electrical Characteristics ($T_A=25^\circ\text{C}$)

Parameter	Min.	Typ.	Max.	Unit	Test Condition		
Emitter							
Forward Voltage		1.4	1.7	V	$I_F = \pm 100$ mA		
Detector							
BV_{CEO}	30	50		V	$I_C = 10$ mA		
BV_{ECO}	7	10		V	$I_E = 10$ μ A		
BV_{CBO}	70			V	$I_C = 100$ μ A		
BV_{EBO}	7			V	$I_E = 100$ μ A		
I_{CEO}		5	50	nA	$V_{CE} = 10$ V		
Package							
Parameter	Device	Symbol	Min.	Typ.	Max.	Unit	Test Condition
Current Transfer Ratio	IL255	CTR	20			%	$I_F = \pm 10$ mA, $V_{CE} = 10$ V
	IL255-1		20		80	%	$I_F = \pm 100$ mA, $V_{CE} = 2$ V
	IL255-2		50			%	$I_F = \pm 10$ mA, $V_{CE} = 10$ V
Current Transfer Ratio Symmetry	IL255		0.33		3.0		$I_F = \pm 10$ mA, $V_{CE} = 10$ V
	IL255-1						
	IL255-2		0.5	1.0	2.0		$I_F = \pm 10$ mA, $V_{CE} = 10$ V
Collector-emitter Saturation Voltage	IL255	$V_{CE(sat)}$			0.4	V	$I_F = \pm 10$ mA, $I_C = 0.5$ mA
	IL255-1			0.1	0.2	V	$I_F = \pm 100$ mA, $I_C = 1$ mA
	IL255-2				0.4	V	$I_F = \pm 16$ mA, $I_C = 2$ mA

Figure 1. LED forward current versus forward voltage

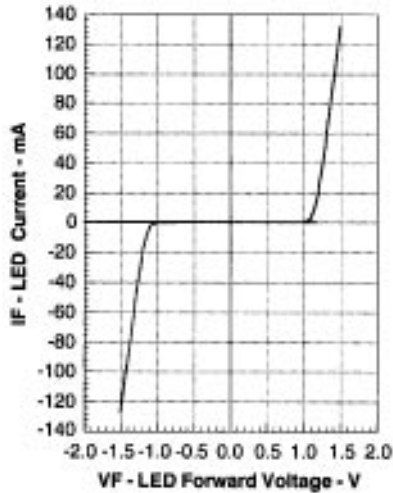

Figure 2. Maximum LED current versus ambient temperature

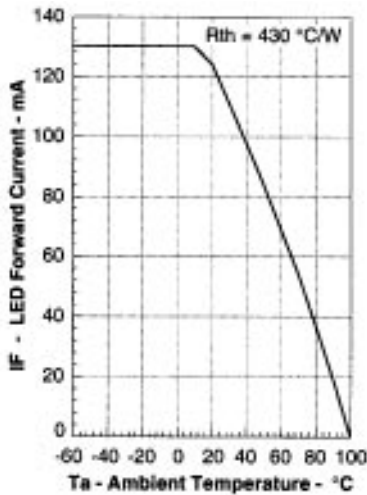

Figure 7. Collector-emitter current versus LED collector-emitter voltage

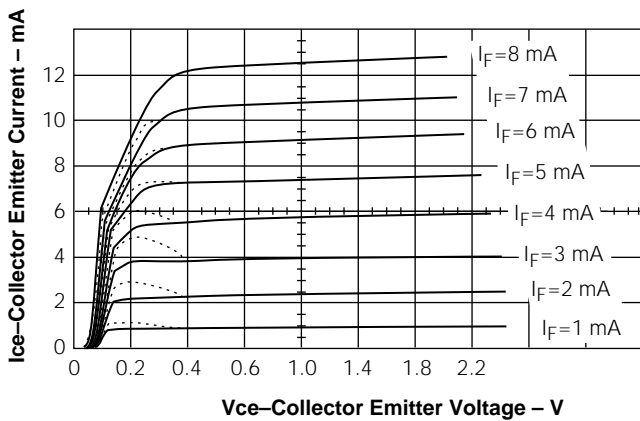

Figure 3. Maximum LED power dissipation

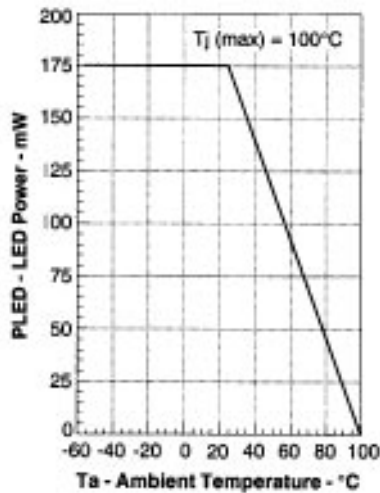

Figure 4. Current transfer ratio versus LED current and collector-emitter voltage

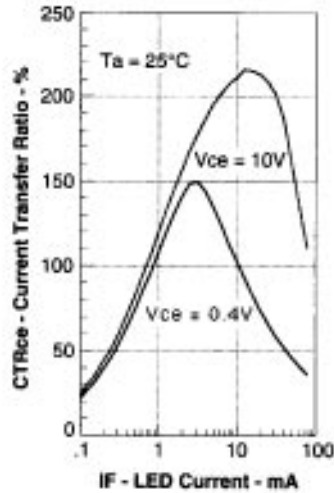

Figure 5. Saturated and non-saturated collector-emitter current versus LED current

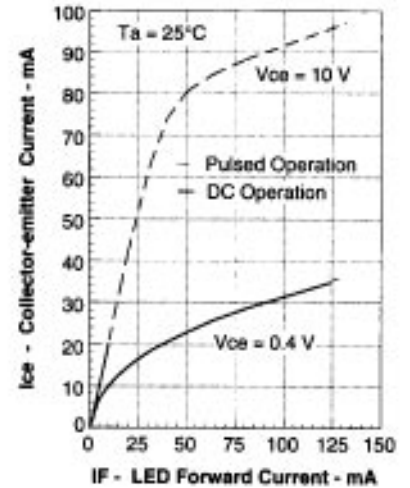

Figure 6. Saturated and non-saturated collector-emitter current versus LED current

