

**Amplifier, Power, 1.0 W  
4.4-7.0 GHz**

**MAAP-000073-PKG003**

Rev -  
Preliminary Datasheet

**Features**

- ◆ **1.0 Watt Saturated Output Power Level**
- ◆ **Variable Drain Voltage (6-10V) Operation**
- ◆ **MSAG™ Process**

**Description**

The MAAP-000073-PKG003 is a 3-stage 1.0 W power amplifier with on-chip bias networks in a 20 lead, 5 mm PQFN package, allowing easy assembly. This product is fully matched to 50 ohms on both the input and output. It can be used as a power amplifier stage or as a driver stage in high power applications.

Each device is 100% RF tested to ensure performance compliance. The part is fabricated using M/A-COM's GaAs Multifunction Self-Aligned Gate (MSAG) Process.

The 5 mm PQFN package has a lead-free finish of leads that are RoHS compliant and is compatible with a 260°C reflow temperature. The package also features low lead inductance and an excellent thermal path. The MTTF is 1,000,000 hours at 170°C.

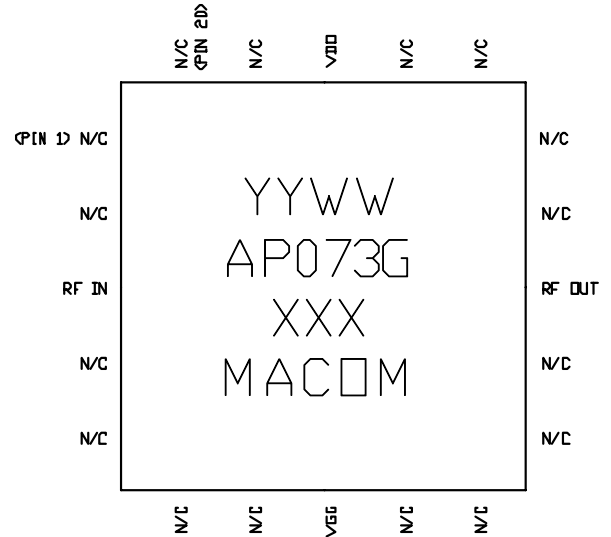

**Primary Applications**

- ◆ **Point-to-Point Radio**
- ◆ **5 and 6 GHz Bands**

**Also Available in:**

Description	Die	Ceramic Package	Ceramic Pkg Sample Board	Die Sample Board
Part Number	MAAPGM0073-DIE	MAAPGM0073	MAAP-000073-SMB003	MAAP-000073-SMB004

**Electrical Characteristics:  $T_C = 35^\circ C^1$ ,  $Z_0 = 50 \Omega$ ,  $V_{DD} = 8V$ ,  $I_{DQ} = 330mA^2$ ,  $P_{in} = 8dBm$ ,  $R_G = 220\Omega$**

Parameter	Symbol	Typical	Units
Bandwidth	f	4.4-7.0	GHz
Output Power	$P_{OUT}$	30	dBm
1-dB Compression Point	$P_{1dB}$	29	dBm
Small Signal Gain	G	26	dB
Input VSWR	VSWR	1.3:1	
Output VSWR	VSWR	2.5:1	
Gate Current	$I_{GG}$	5.0	mA
Drain Current	$I_{DD}$	460	mA
Output Third Order Intercept	TOI	38	dBm
Output Third Order Intermod, $P_{out} = 19 \text{ dBm (DCL)}$	IMD3	40	dBc

1.  $T_C$  = Case Temperature
2. Adjust  $V_{GG}$  between -2.5 and -1.2V to achieve specified  $I_{DQ}$ .

### Maximum Ratings<sup>3</sup>

Parameter	Symbol	Absolute Maximum	Units
Input Power	$P_{IN}$	12.0	dBm
Drain Supply Voltage	$V_{DD}$	+12.0	V
Gate Supply Voltage	$V_{GG}$	-3.0	V
Quiescent Drain Current (No RF)	$I_{DQ}$	520	mA
Quiescent DC Power Dissipated (No RF)	$P_{DISS}$	2.8	W
Junction Temperature	$T_J$	170	°C
Storage Temperature	$T_{STG}$	-55 to +150	°C

3. Operation beyond these limits may result in permanent damage to the part.

### Recommended Operating Conditions<sup>4</sup>

Characteristic	Symbol	Min	Typ	Max	Unit
Drain Voltage	$V_{DD}$	6.0	8.0	10.0	V
Gate Voltage	$V_{GG}$	-2.5	-2.0	-1.2	V
Input Power	$P_{IN}$		6.0	8.0	dBm
Thermal Resistance	$\Theta_{JC}$		34.8		°C/W
Case Temperature	$T_C$			Note 5	°C

4. Operation outside of these ranges may reduce product reliability.

5. Case Temperature =  $170^{\circ}\text{C} - \Theta_{JC} * V_{DD} * I_{DQ}$



### Operating Instructions

This device is static sensitive. Please handle with care. To operate the device, follow these steps.

1. Apply  $V_{GG} = -2\text{ V}$ ,  $V_{DD} = 0\text{ V}$ .
2. Ramp  $V_{DD}$  to desired voltage, typically 8.0 V.
3. Adjust  $V_{GG}$  to set  $I_{DQ}$ , (approximately @  $-2\text{ V}$ ).
4. Set RF input.
5. Power down sequence in reverse. Turn  $V_{GG}$  off last.

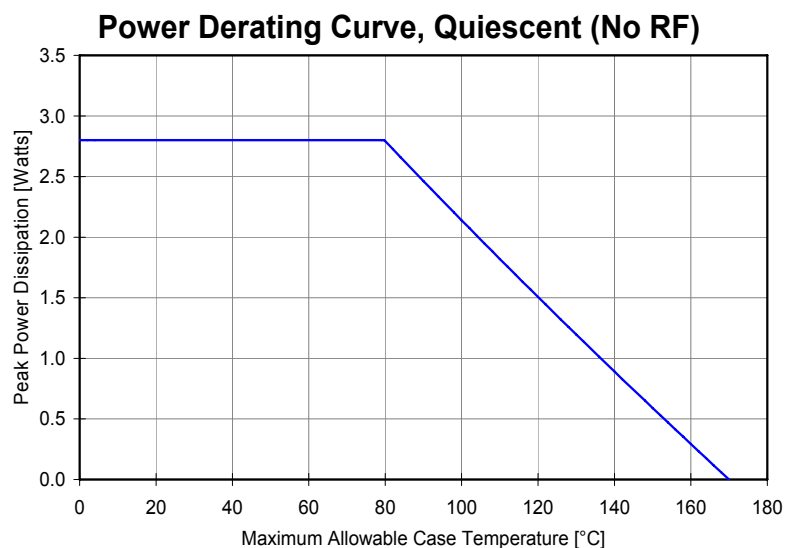

**Amplifier, Power, 1.0 W  
4.4-7.0 GHz**

**MAAP-000073-PKG003**

Rev -  
Preliminary Datasheet

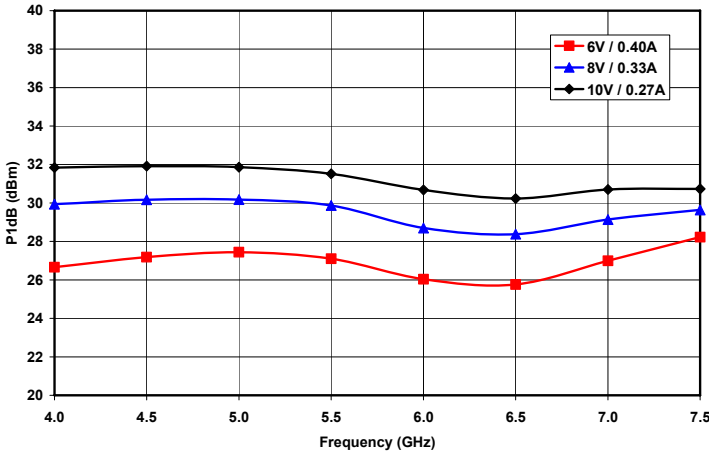

Figure 1. P1dB vs. Frequency and Quiescent Bias Condition (VDD / IDQ)

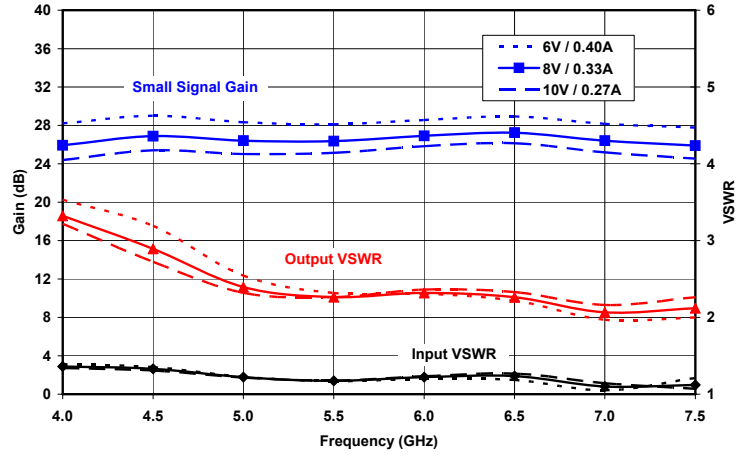

Figure 2. Small Signal Gain and Input & Output VSWR vs. Frequency and Quiescent Bias (Vdd / IDQ)

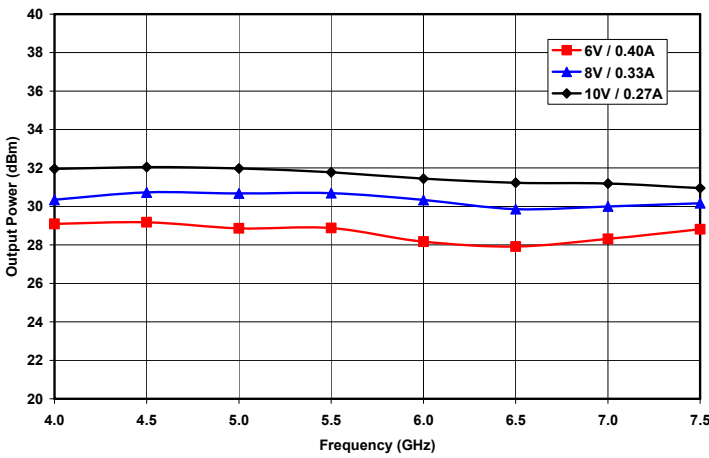

Figure 3. Saturated Output Power vs. Frequency and Quiescent Bias Condition (VDD / IDQ)

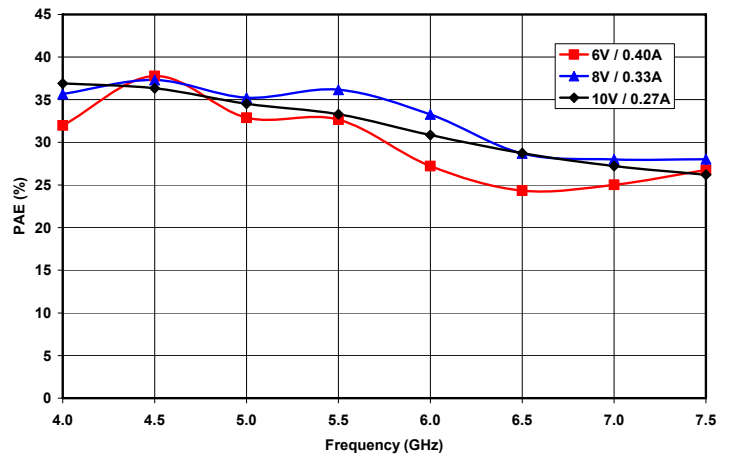

Figure 4. Saturated Power Added Efficiency vs. Frequency and Quiescent Bias Condition (VDD / IDQ)

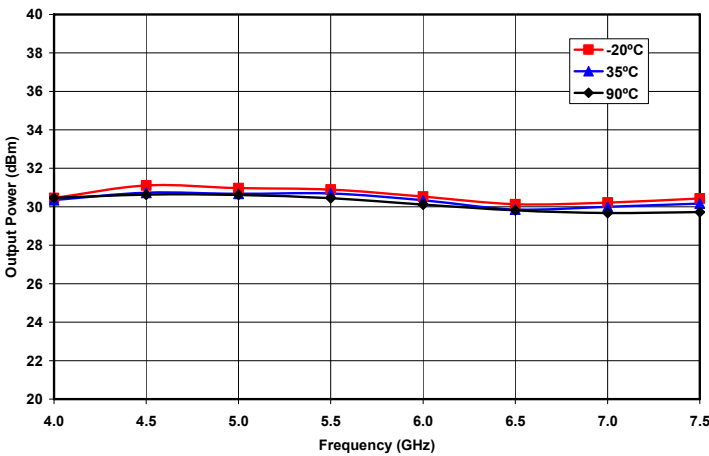

Figure 5. Saturated Output Power vs. Frequency and Case Temperature at VD = 8V and IDQ = 0.33A

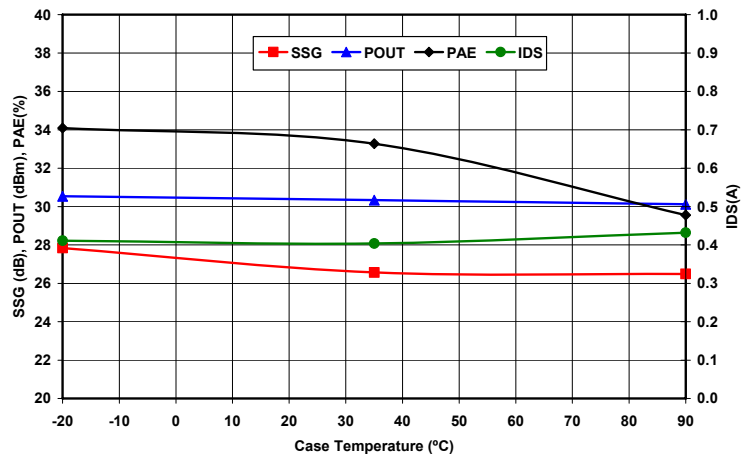

Figure 6. Small Signal Gain & Saturated Output Power, Power Added Efficiency and Drain Current vs. Case Temperature at 6.0 GHz, VD = 8V, and IDQ = 0.33A

**Amplifier, Power, 1.0 W  
4.4-7.0 GHz**

**MAAP-000073-PKG003**

Rev -  
Preliminary Datasheet

**VD = 6V**

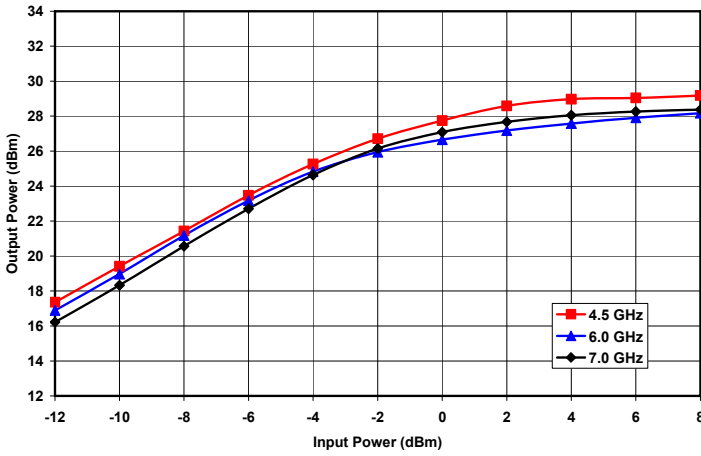

Figure 7. Output Power vs. Input Power and Frequency at VD = 6V and IDQ = 0.40A

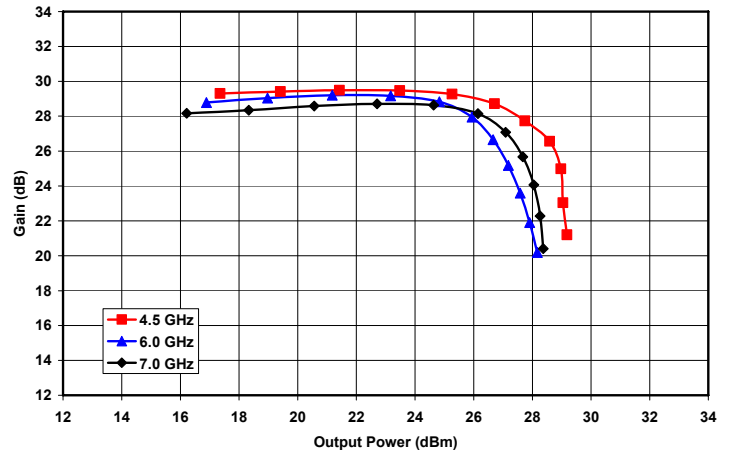

Figure 8. Gain vs. Output Power and Frequency at VD = 6V and IDQ = 0.40A

**VD = 8V**

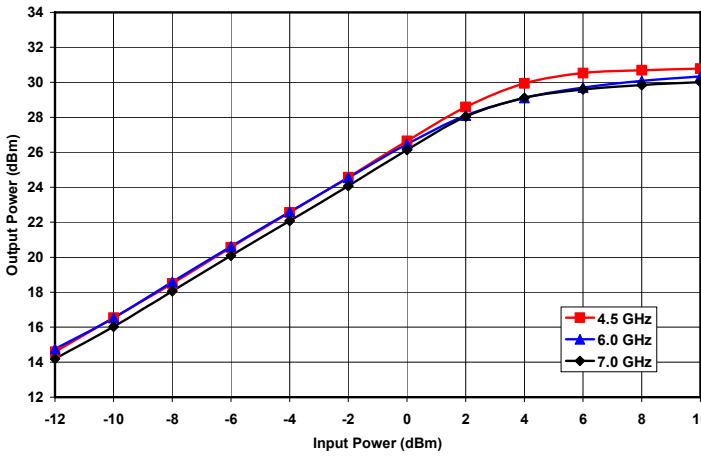

Figure 9. Output Power vs. Input Power and Frequency at VD = 8V and IDQ = 0.33A

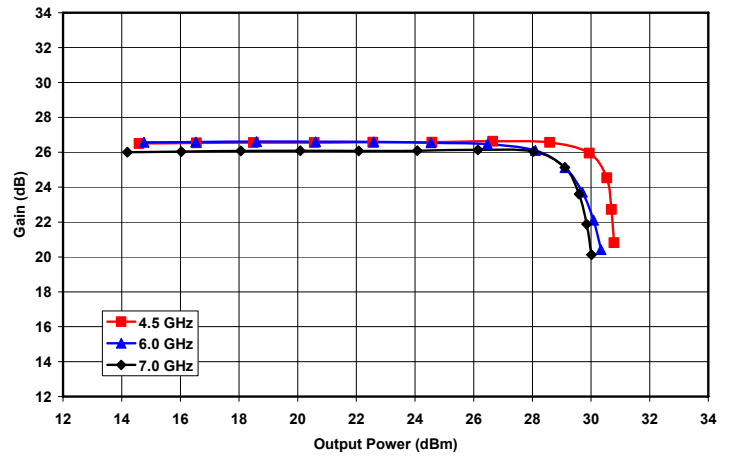

Figure 10. Gain vs. Output Power and Frequency at VD = 8V and IDQ = 0.33A

**VD = 10V**

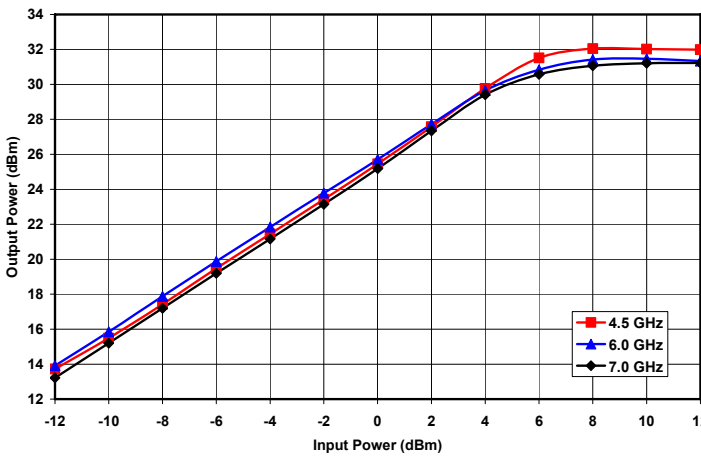

Figure 11. Output Power vs. Input Power and Frequency at VD = 10V and IDQ = 0.27A

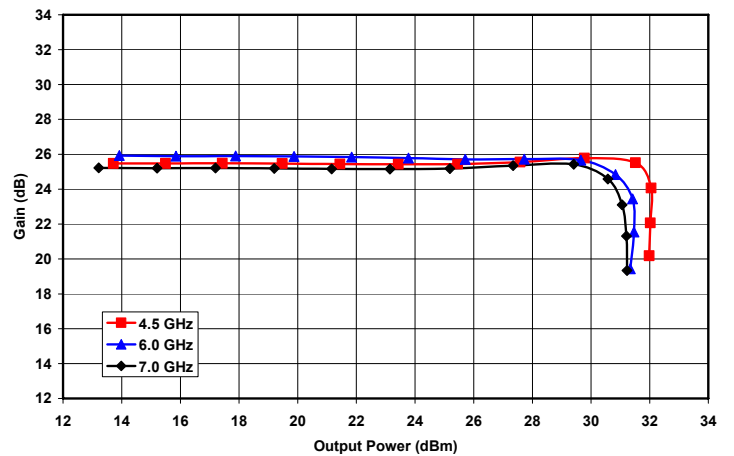

Figure 12. Gain vs. Output Power and Frequency at VD = 10V and IDQ = 0.27A

**Amplifier, Power, 1.0 W  
4.4-7.0 GHz**

**MAAP-000073-PKG003**

Rev -  
Preliminary Datasheet

**VD = 6V**

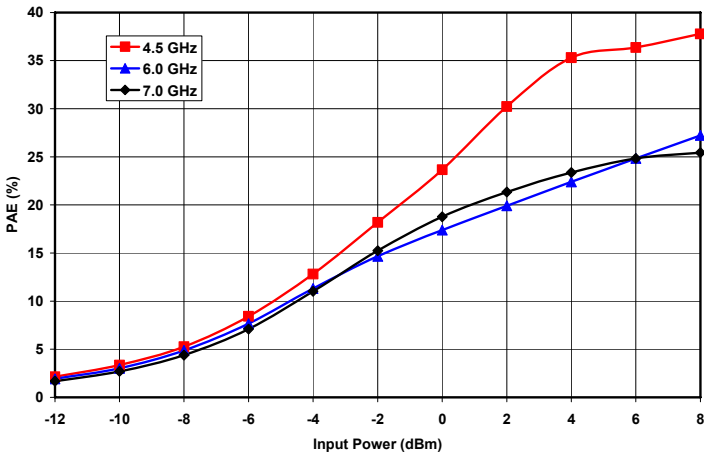

Figure 13. Power Added Efficiency vs. Input Power and Frequency at VD = 6V and IDQ = 0.40A

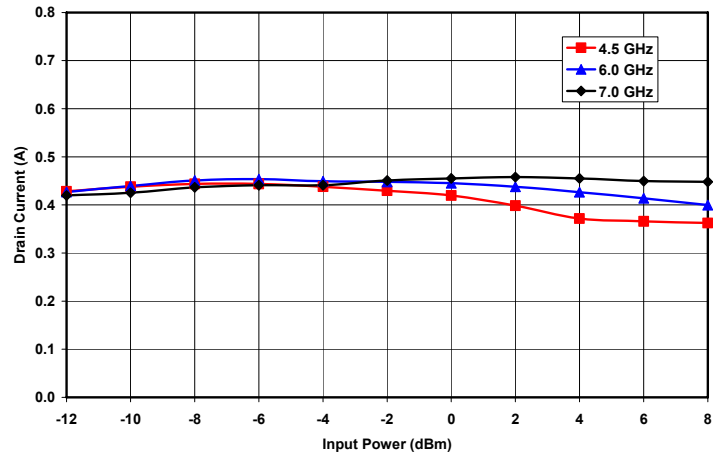

Figure 14. Drain Current vs. Input Power and Frequency at VD = 6V and IDQ = 0.40A

**VD = 8V**

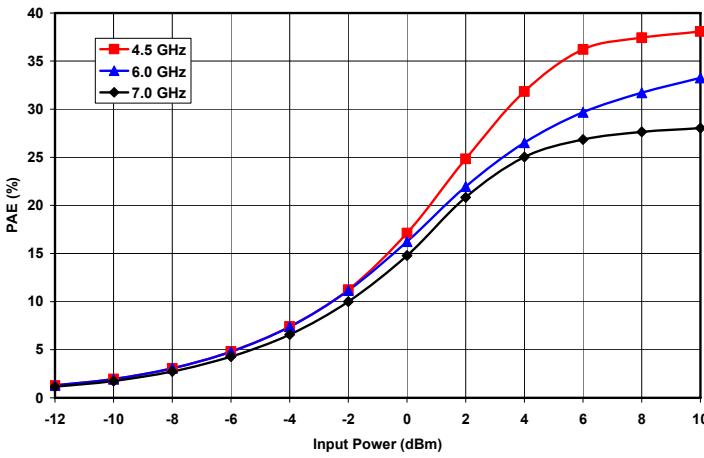

Figure 15. Power Added Efficiency vs. Input Power and Frequency at VD = 8V and IDQ = 0.33A

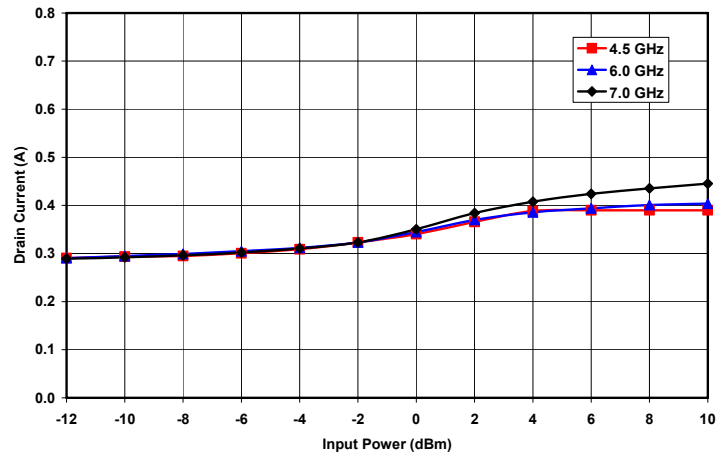

Figure 16. Drain Current vs. Input Power and Frequency at VD = 8V and IDQ = 0.33A

**VD = 10V**

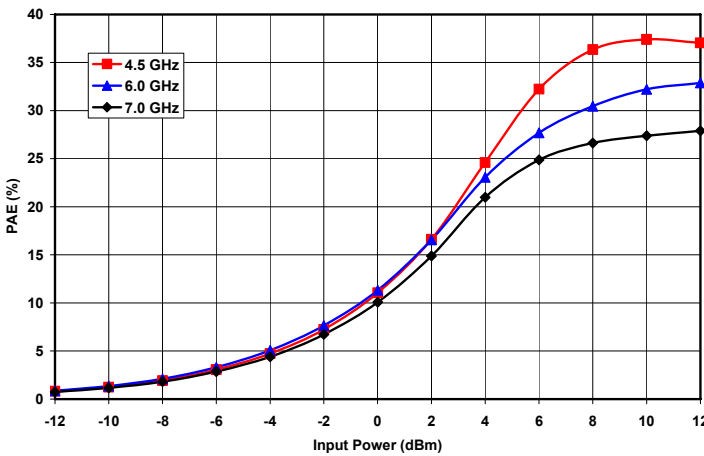

Figure 17. Power Added Efficiency vs. Input Power and Frequency at VD = 10V and IDQ = 0.27A

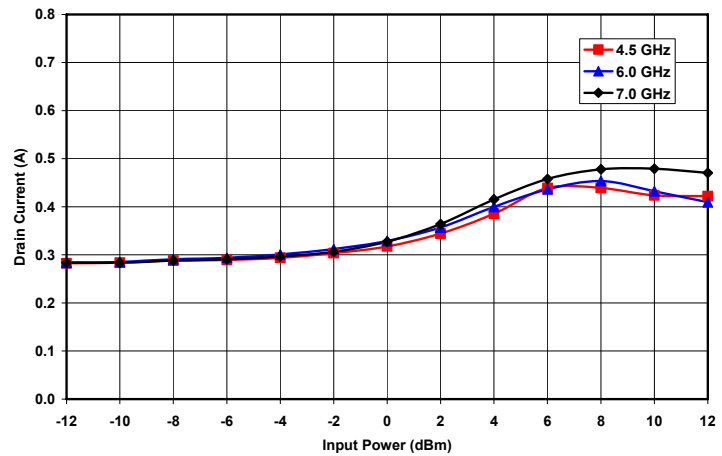

Figure 18. Drain Current vs. Input Power and Frequency at VD = 10V and IDQ = 0.27A

**Amplifier, Power, 1.0 W  
4.4-7.0 GHz**

**MAAP-000073-PKG003**

Rev -  
Preliminary Datasheet

**VD = 6V**

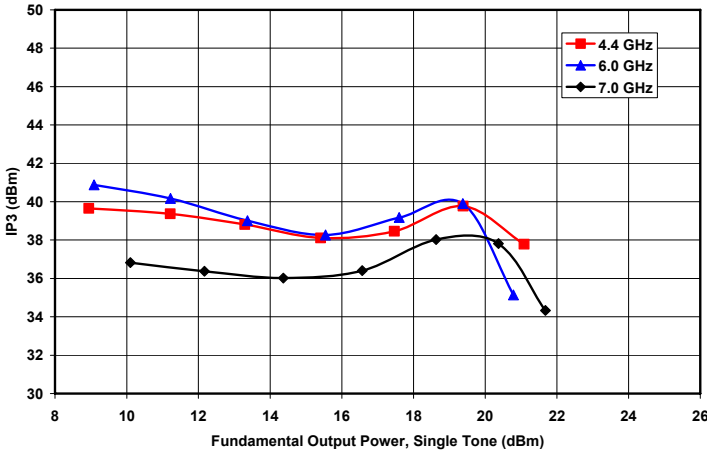

Figure 19. Third Order Intercept vs. Output Power and Frequency at VD = 6V and IDQ = 0.40A

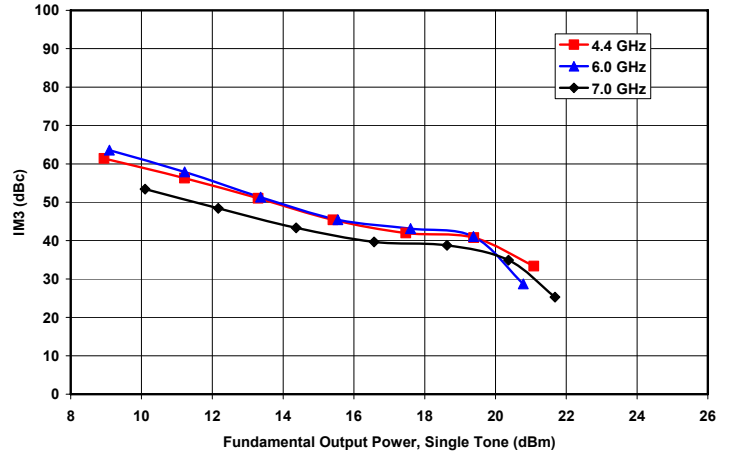

Figure 20. Third Order Intermod vs. Output Power and Frequency at VD = 6V and IDQ = 0.40A

**VD = 8V**

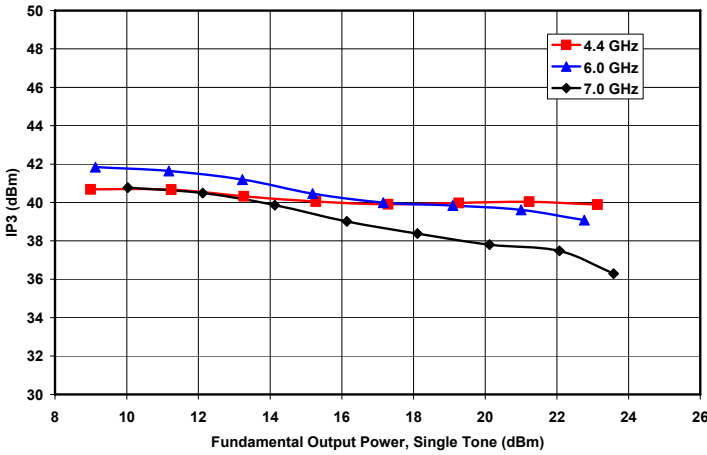

Figure 21. Third Order Intercept vs. Output Power and Frequency at VD = 8V and IDQ = 0.33A

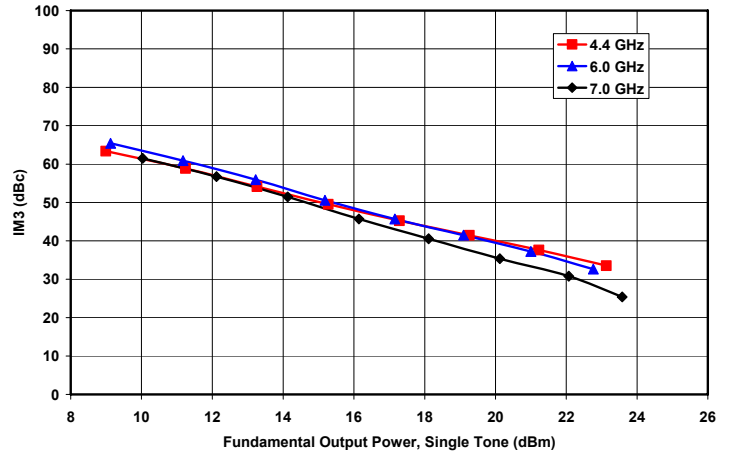

Figure 22. Third Order Intermod vs. Output Power and Frequency at VD = 8V and IDQ = 0.33A

**VD = 10V**

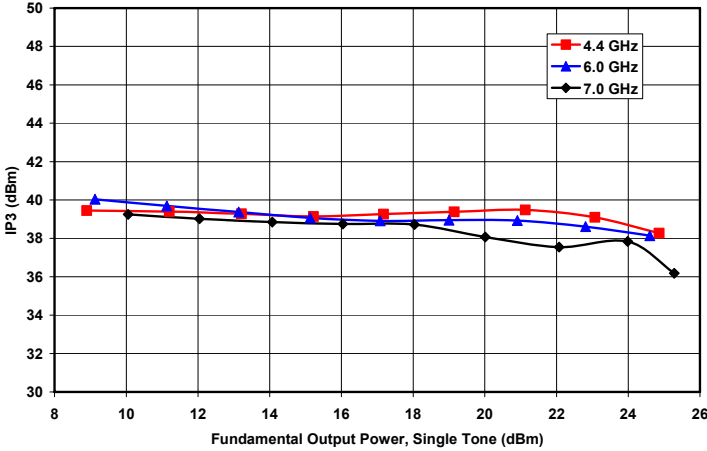

Figure 23. Third Order Intercept vs. Output Power and Frequency at VD = 10V and IDQ = 0.27A

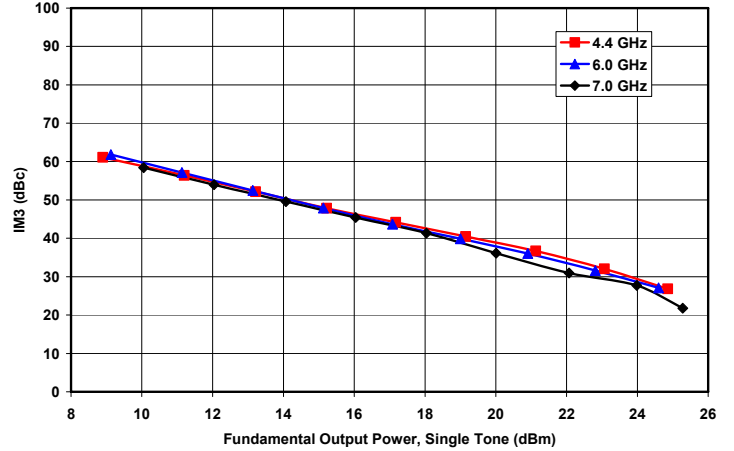

Figure 24. Third Order Intermod vs. Output Power and Frequency at VD = 10V and IDQ = 0.27A

**Amplifier, Power, 1.0 W  
4.4-7.0 GHz**

**MAAP-000073-PKG003**

Rev -  
Preliminary Datasheet

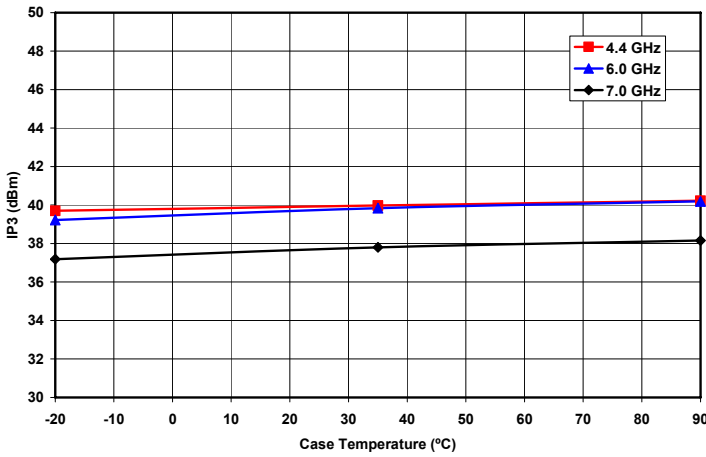

Figure 25. Third Order Intercept vs. Case Temperature and Frequency at Single Carrier Output Power Level = 19 dBm, VD = 8V and IDQ = 0.33A

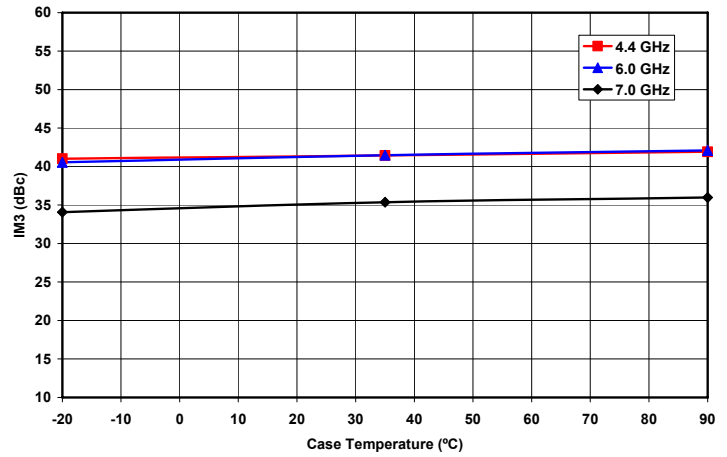
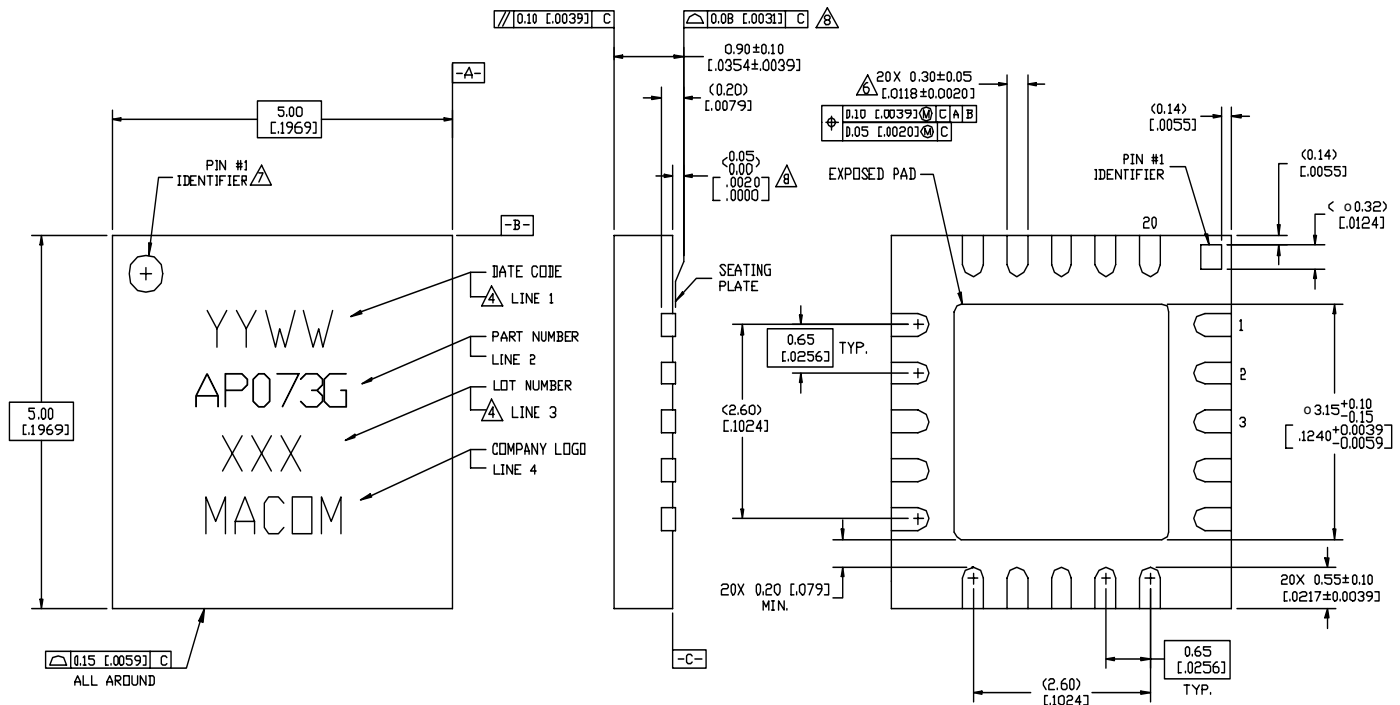

Figure 26. Third Order Intermod vs. Case Temperature and Frequency at Single Carrier Output Power Level = 19 dBm, VD = 8V and IDQ = 0.33A

**Amplifier, Power, 1.0 W  
4.4-7.0 GHz**

**MAAP-000073-PKG003**

Rev -  
Preliminary Datasheet



**Figure 27. 5x5 mm 20-Lead MLP.**

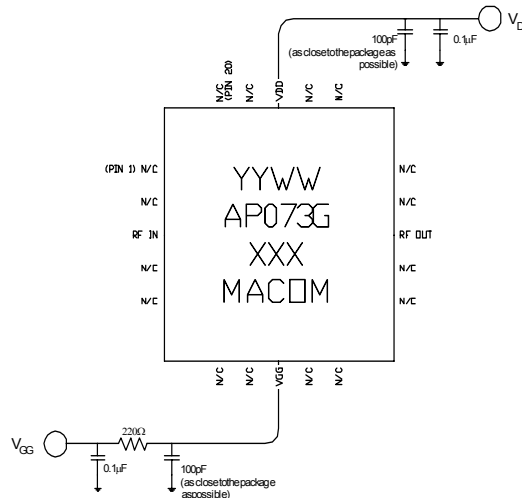

**Figure 28. Recommended Bias Configuration.**

Note: The exposed pad centered on the package bottom must be connected to RF and dc ground for proper electrical and thermal operation.

Refer to M/A-COM Application Note **Surface Mounting Instructions for PQFN Packages #S2083\*** for assembly guidelines.

**Additional Precaution: All parts must receive a bake-out of 125°C for 24 hours prior to any solder reflow operation.**

\*Application Notes can be found by going to the Site Search Page of M/A-COM's web page (<http://www.macom.com/Application%20Notes/index.htm>) and searching for the required Application Note.



Amplifier, Power, 1.0 W  
4.4-7.0 GHz

MAAP-000073-PKG003

Rev -  
Preliminary Datasheet

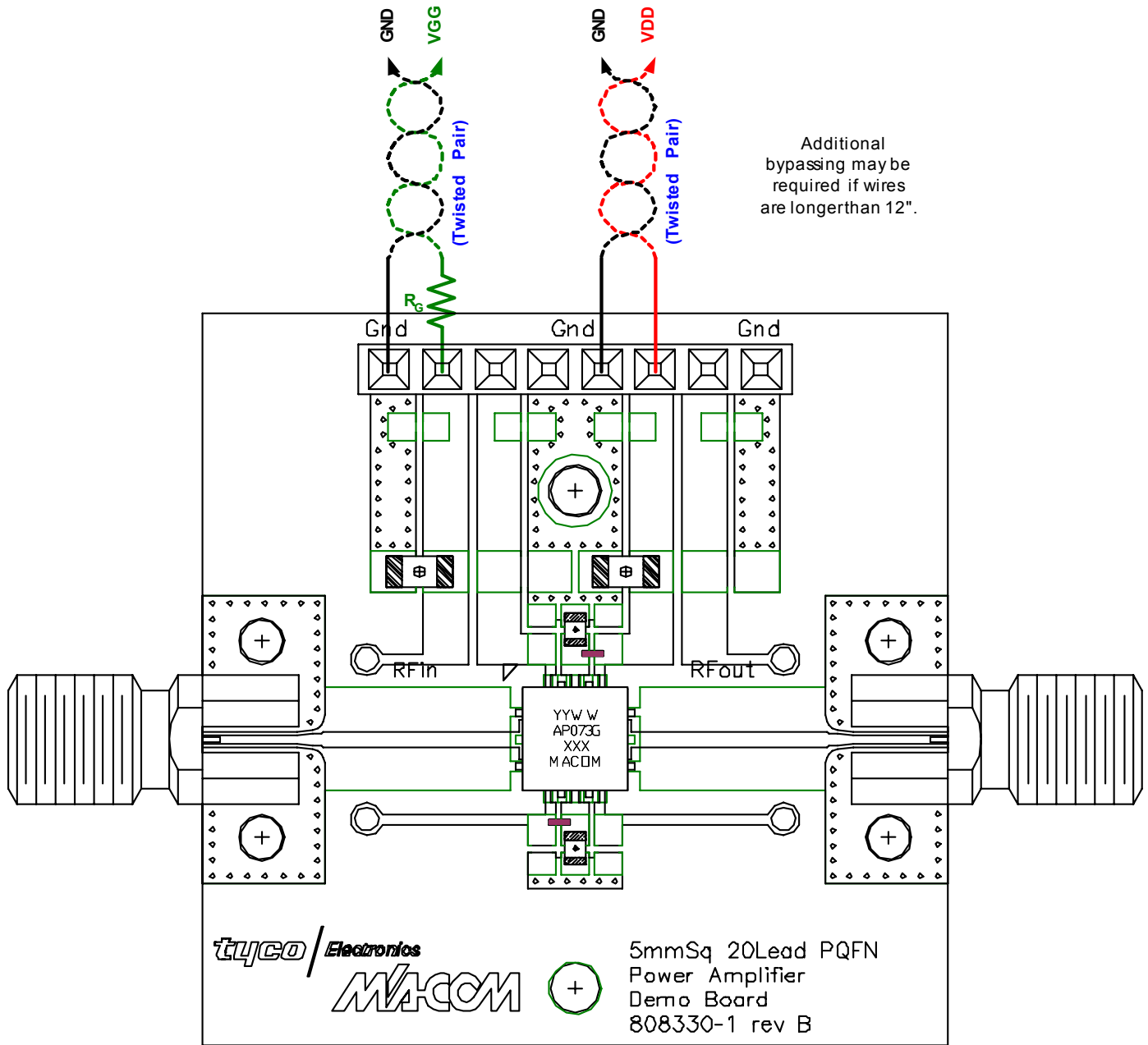

Figure 29. Demonstration Board P/N MAAP-000073-SMB003 (available upon request).