

HPI - 6FFR4

The HPI - 6FFR4 is a high - output, high - speed silicon PIN photodiode mounted in a sidelooking package. The photodiode is small size, low profile and easy mounting.

FEATURES

- High - output power
- High - speed response
- Wide angular response
- Low - cost
- Sidelooking plastic package

APPLICATIONS

- Remote control sensors
- Optical switches
- Photocoupler

DIMENSIONS

(Unit : mm)

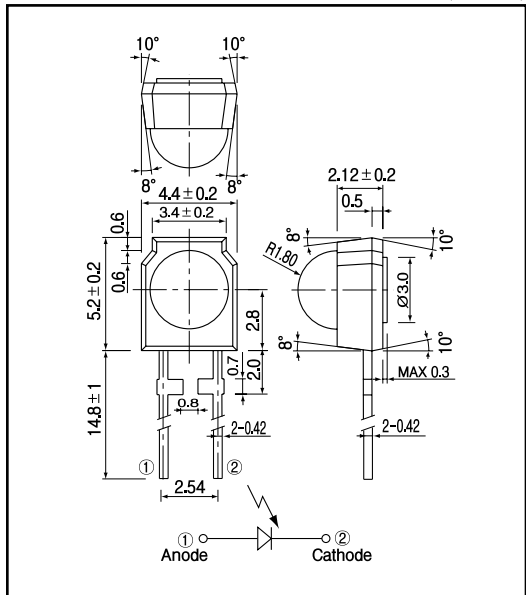

MAXIMUM RATINGS

(Ta=25)

Item	Symbol	Rating	Unit
Reverse voltage	V_R	35	V
Operating temp.	$T_{opr.}$	- 30 +70	
Storage temp.	$T_{stg.}$	- 40 +80	
Soldering temp.*1	$T_{sol.}$	260	

*1.For MAX.5 seconds at the position of 2 mm from the package

ELECTRO-OPTICAL CHARACTERISTICS

(Ta=25)

Item	Symbol	Conditions	Min.	Typ.	Max.	Unit.
Open circuit voltage	V_{oc}	$E_v = 1,000lx^2$		0.38		V
Short circuit current	I_{sc}			20		μA
Curve factor	C.F.	$V_R = 10V$			10	nA
Dark current	I_d		0.55			-
Capacitance	C_t	$V = 0V, f = 1MHz$		16		pF
Temperature coefficient of V_{oc}	t			- 2.2		mV/
Temperature coefficient of I_{sc}	t			0.18		%/
Spectral sensitivity				880 1050		nm
Peak wavelength	λ_p			1,000		nm
Half angle				± 35		deg

*2.Color temp.=2856K standard Tungsten lamp

PIN Photodiode

HPI - 6FFR4

Light current Vs. Forward voltage

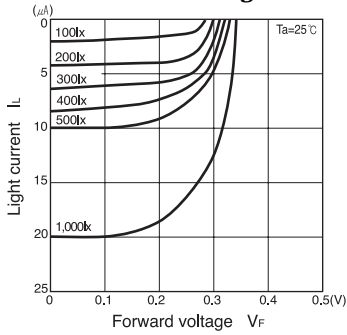

Short circuit current I_sc Vs. Illuminance E_v

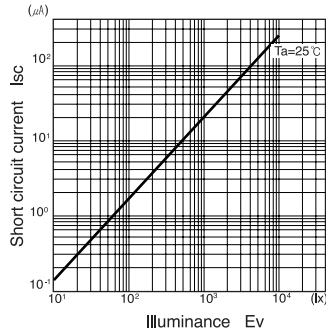

Dark current I_d Vs. Ambient temperature T_a

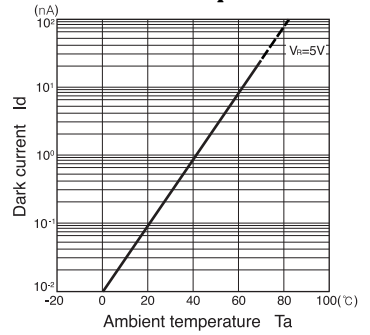

Relative sensitivity S Vs. Wavelength λ

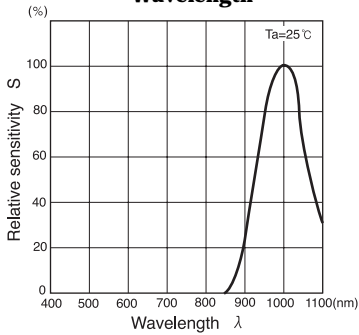

Dark current I_d Vs. Reverse voltage V_R

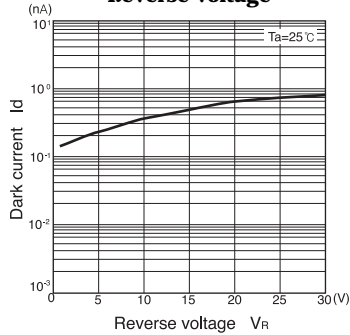

Radiant Pattern

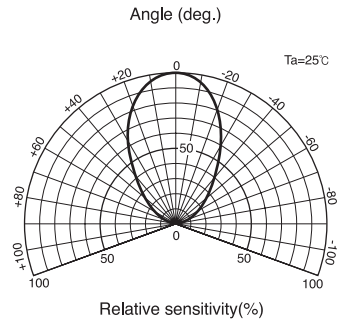

Capacitance between terminals C_t Vs. Reverse voltage V_R

