

# Cree® Screen Master® 4-mm Oval LED

## C4SMK-RJS/GJS/BJS

## C4SMJ-RJS

### Data Sheet

This oval LED is specifically designed for full color video screens, variable-message signs and passenger-information signs. The oval-shaped radiation pattern and high luminous intensity ensure that these devices are excellent for wide-field-of-view outdoor applications where a wide viewing angle and readability in sunlight are essential

These lamps are made with an advanced optical-grade epoxy that offers superior high-temperature and high-moisture-resistance performance in outdoor signal and sign applications. The encapsulation resin contains anti-UV material in order to reduce the effects of long-term exposure to direct sunlight.



#### FEATURES

- Size (mm): 4
- Color and Typical Dominant Wavelength (nm):
  - » Red (621)
  - » Green (527)
  - » Blue (470)
- Luminous Intensity (mcd)
  - » C4SMK - Red (550-2130)  
Green (1100-4180)  
Blue (390-1520)
  - » C4SMJ - Red (390-1520)
- Lead-Free
- RoHS-Compliant

#### APPLICATIONS

- Electronic Signs & Signals (ESS)
- Full-Color Video Screen
- Motorway Signs
- Variable-Message Sign (VMS)
- Advertising Signs
- Petrol Signs



## Absolute Maximum Ratings ( $T_A = 25^\circ\text{C}$ )

Items	Symbol	Absolute Maximum Rating		Unit
		Red	Blue and Green	
Forward Current	$I_F$	50 <sup>Note1</sup>	35	mA
Peak Forward Current <sup>Note2</sup>	$I_{FP}$	200	100	mA
Reverse Voltage	$V_R$	5	5	V
Power Dissipation	$P_D$	130	140	mW
Operation Temperature	$T_{opr}$	-40 ~ +95		$^\circ\text{C}$
Storage Temperature	$T_{stg}$	-40 ~ +100		$^\circ\text{C}$
Lead Soldering Temperature	$T_{sol}$	Max. 260 $^\circ\text{C}$ for 3 sec. max. (3 mm from the base of the epoxy bulb)		
Electrostatic Discharge Classification (MIL-STD-883E)	ESD	Class 2		

### Note:

1. For long-term performance, the drive currents between 10 mA and 30 mA are recommended. Please contact a Cree sales representative for more information on recommended drive conditions.
2. Pulse width  $\leq 0.1$  msec, duty  $\leq 1/10$ .

## Typical Electrical & Optical Characteristics ( $T_A = 25^\circ\text{C}$ )

Characteristics	Color	Symbol	Condition	Unit	Minimum	Typical	Maximum
Forward Voltage	Red	$V_F$	$I_F = 20$ mA	V		2.0	2.6
	Green	$V_F$	$I_F = 20$ mA	V		3.4	4.0
	Blue	$V_F$	$I_F = 20$ mA	V		3.2	4.0
Reverse Current	Red	$I_R$	$V_R = 5$ V	$\mu\text{A}$			100
	Blue/Green	$I_R$	$V_R = 5$ V	$\mu\text{A}$			100
Dominant Wavelength	Red	$\lambda_D$	$I_F = 20$ mA	nm	619	621	624
	Green	$\lambda_D$	$I_F = 20$ mA	nm	520	527	535
	Blue	$\lambda_D$	$I_F = 20$ mA	nm	460	470	475
Luminous Intensity	C4SMK- Red	$I_V$	$I_F = 20$ mA	mcd	550	1300	
	C4SMJ - Red	$I_V$	$I_F = 20$ mA	mcd	390	800	
	Green	$I_V$	$I_F = 20$ mA	mcd	1100	2900	
	Blue	$I_V$	$I_F = 20$ mA	mcd	390	780	



## Intensity Bin Limit ( $I_F = 20 \text{ mA}$ )

Red: C4SMK

Bin Code	Sub-bin	Min. (mcd)	Max. (mcd)
R0	R1	550	605
	R2	605	660
	R3	660	715
	R4	715	770
S0	S1	770	852
	S2	852	934
	S3	934	1017
	S4	1017	1100
T0	T1	1100	1205
	T2	1205	1310
	T3	1310	1415
	T4	1415	1520
U0	U1	1520	1672
	U2	1672	1824
	U3	1824	1976
	U4	1976	2130

Green: C4SMK

Bin Code	Sub-bin	Min. (mcd)	Max. (mcd)
T0	T1	1100	1205
	T2	1205	1310
	T3	1310	1415
	T4	1415	1520
U0	U1	1520	1672
	U2	1672	1824
	U3	1824	1976
	U4	1976	2130
V0	V1	2130	2347
	V2	2347	2564
	V3	2564	2781
	V4	2781	3000
W0	W1	3000	3295
	W2	3295	3590
	W3	3590	3885
	W4	3885	4180

Blue: C4SMK

Bin Code	Sub-bin	Min. (mcd)	Max. (mcd)
Q0	Q1	390	430
	Q2	430	470
	Q3	470	510
	Q4	510	550
R0	R1	550	605
	R2	605	660
	R3	660	715
	R4	715	770
S0	S1	770	852
	S2	852	934
	S3	934	1017
	S4	1017	1100
T0	T1	1100	1205
	T2	1205	1310
	T3	1310	1415
	T4	1415	1520

Red: C4SMJ

Bin Code	Sub-bin	Min. (mcd)	Max. (mcd)
Q0	Q1	390	430
	Q2	430	470
	Q3	470	510
	Q4	510	550
R0	R1	550	605
	R2	605	660
	R3	660	715
	R4	715	770
S0	S1	770	852
	S2	852	934
	S3	934	1017
	S4	1017	1100
T0	T1	1100	1205
	T2	1205	1310
	T3	1310	1415
	T4	1415	1520

Tolerance of measurement of luminous intensity is  $\pm 15\%$

## Color Bin Limit ( $I_F = 20 \text{ mA}$ )

Red

Bin Code	Min.(nm)	Max.(nm)
RB	619	624

Green

Bin Code	Min.(nm)	Max.(nm)
G7	520	525
G8	525	530
G9	530	535

Blue

Bin Code	Min.(nm)	Max.(nm)
B3	460	465
B4	465	470
B5	470	475

Tolerance of measurement of dominant wavelength is  $\pm 1 \text{ nm}$



## Order Code Table\*

### C4SMK

Color	Kit Number	Luminous Intensity (mcd)		Dominant Wavelength				Pack- age
		Min.	Max.	Color Bin	Min. (nm)	Color Bin	Max. (nm)	
Red	C4SMK-RJS-CR0U0BB1	550	2130	RB	619	RB	624	Bulk
Red	C4SMK-RJS-CS24QBB1	Any 4 consecutive sub-bins: S2 (852) - T3 (1415)		RB	619	RB	624	Bulk
Red	C4SMK-RJS-CS44QBB1	Any 4 consecutive sub-bins: S4 (1017) - U1 (1672)		RB	619	RB	624	Bulk
Red	C4SMK-RJS-CT24QBB1	Any 4 consecutive sub-bins: T2 (1205) - U3 (1976)		RB	619	RB	624	Bulk
Red	C4SMK-RJS-CR0U0BB2	550	2130	RB	619	RB	624	Ammo
Red	C4SMK-RJS-CS24QBB2	Any 4 consecutive sub-bins: S2 (852) - T3 (1415)		RB	619	RB	624	Ammo
Red	C4SMK-RJS-CS44QBB2	Any 4 consecutive sub-bins: S4 (1017) - U1 (1672)		RB	619	RB	624	Ammo
Red	C4SMK-RJS-CT24QBB2	Any 4 consecutive sub-bins: T2 (1205) - U3 (1976)		RB	619	RB	624	Ammo

Color	Kit Number	Luminous Intensity (mcd)		Dominant Wavelength				Pack- age
		Min.	Max.	Color Bin	Min. (nm)	Color Bin	Max. (nm)	
Green	C4SMK-GJS-CT0W0791	1100	4180	G7	520	G9	535	Bulk
Green	C4SMK-GJS-CU34Q7S1	Any 4 consecutive sub-bins:U3 (1824) - V4 (3000)		Any 1 color bin from G7 (520 nm) to G9 (535 nm)				Bulk
Green	C4SMK-GJS-CU34Q7T1	Any 4 consecutive sub-bins: U3 (1824) - V4 (3000)		Any 1 color bin from G7 (520 nm) to G8 (530 nm)				Bulk
Green	C4SMK-GJS-CU34Q8T1	Any 4 consecutive sub-bins: U3 (1824) - V4 (3000)		Any 1 color bin from G8 (525 nm) to G9 (535 nm)				Bulk
Green	C4SMK-GJS-CV14Q7S1	Any 4 consecutive sub-bins:V1 (2130) - W2 (3590)		Any 1 color bin from G7 (520 nm) to G9 (535 nm)				Bulk
Green	C4SMK-GJS-CV14Q7T1	Any 4 consecutive sub-bins:V1 (2130) - W2 (3590)		Any 1 color bin from G7 (520 nm) to G8 (530 nm)				Bulk
Green	C4SMK-GJS-CV14Q8T1	Any 4 consecutive sub-bins:V1 (2130) - W2 (3590)		Any 1 color bin from G8 (525 nm) to G9 (535 nm)				Bulk
Green	C4SMK-GJS-CV34Q7S1	Any 4 consecutive sub-bins:V3 (2564) - W4 (4180)		Any 1 color bin from G7 (520 nm) to G9 (535 nm)				Bulk
Green	C4SMK-GJS-CV34Q7T1	Any 4 consecutive sub-bins:V3 (2564) - W4 (4180)		Any 1 color bin from G7 (520 nm) to G8 (530 nm)				Bulk
Green	C4SMK-GJS-CV34Q8T1	Any 4 consecutive sub-bins:V3 (2564) - W4 (4180)		Any 1 color bin from G8 (525 nm) to G9 (535 nm)				Bulk
Green	C4SMK-GJS-CT0W0792	1100	4180	G7	520	G9	535	Ammo
Green	C4SMK-GJS-CU34Q7S2	Any 4 consecutive sub-bins:U3 (1824) - V4 (3000)		Any 1 color bin from G7 (520 nm) to G9 (535 nm)				Ammo
Green	C4SMK-GJS-CU34Q7T2	Any 4 consecutive sub-bins: U3 (1824) - V4 (3000)		Any 1 color bin from G7 (520 nm) to G8 (530 nm)				Ammo
Green	C4SMK-GJS-CU34Q8T2	Any 4 consecutive sub-bins: U3 (1824) - V4 (3000)		Any 1 color bin from G8 (525 nm) to G9 (535 nm)				Ammo
Green	C4SMK-GJS-CV14Q7S2	Any 4 consecutive sub-bins:V1 (2130) - W2 (3590)		Any 1 color bin from G7 (520 nm) to G9 (535 nm)				Ammo
Green	C4SMK-GJS-CV14Q7T2	Any 4 consecutive sub-bins:V1 (2130) - W2 (3590)		Any 1 color bin from G7 (520 nm) to G8 (530 nm)				Ammo
Green	C4SMK-GJS-CV14Q8T2	Any 4 consecutive sub-bins:V1 (2130) - W2 (3590)		Any 1 color bin from G8 (525 nm) to G9 (535 nm)				Ammo
Green	C4SMK-GJS-CV34Q7S1	Any 4 consecutive sub-bins:V3 (2564) - W4 (4180)		Any 1 color bin from G7 (520 nm) to G9 (535 nm)				Ammo
Green	C4SMK-GJS-CV34Q7T1	Any 4 consecutive sub-bins:V3 (2564) - W4 (4180)		Any 1 color bin from G7 (520 nm) to G8 (530 nm)				Ammo
Green	C4SMK-GJS-CV34Q8T1	Any 4 consecutive sub-bins:V3 (2564) - W4 (4180)		Any 1 color bin from G8 (525 nm) to G9 (535 nm)				Ammo



## Order Code Table\*

Color	Kit Number	Luminous Intensity (mcd)		Dominant Wavelength				Pack- age
		Min.	Max.	Color Bin	Min. (nm)	Color Bin	Max. (nm)	
Blue	C4SMK-BJS-CQ0T0351	390	1520	B3	460	B5	475	Bulk
Blue	C4SMK-BJS-CQ34Q3S1	Any 4 consecutive sub-bins: Q3 (470) - R4 (770)		Any 1 color bin from B3 (460 nm) to B5 (475 nm)				Bulk
Blue	C4SMK-BJS-CQ34Q4T1	Any 4 consecutive sub-bins: Q3 (470) - R4 (770)		Any 1 color bin from B4 (465 nm) to B5 (475 nm)				Bulk
Blue	C4SMK-BJS-CR14Q3S1	Any 4 consecutive sub-bins: R1 (550) - S2 (934)		Any 1 color bin from B3 (460 nm) to B5 (475 nm)				Bulk
Blue	C4SMK-BJS-CR14Q4T1	Any 4 consecutive sub-bins: R1 (550) - S2 (934)		Any 1 color bin from B4 (465 nm) to B5 (475 nm)				Bulk
Blue	C4SMK-BJS-CR34Q3S1	Any 4 consecutive sub-bins: R3 (660) - S4(1100)		Any 1 color bin from B3 (460 nm) to B5 (475 nm)				Bulk
Blue	C4SMK-BJS-CR34Q4T1	Any 4 consecutive sub-bins: R3 (660) - S4(1100)		Any 1 color bin from B4 (465 nm) to B5 (475 nm)				Bulk
Blue	C4SMK-BJS-CS14Q3S1	Any 4 consecutive sub-bins: S1 (770) - T2(1310)		Any 1 color bin from B3 (460 nm) to B5 (475 nm)				Bulk
Blue	C4SMK-BJS-CS14Q4T1	Any 4 consecutive sub-bins: S1 (770) - T2(1310)		Any 1 color bin from B4 (465 nm) to B5 (475 nm)				Bulk
Blue	C4SMK-BJS-CQ0T0352	390	1520	B3	460	B5	475	Ammo
Blue	C4SMK-BJS-CQ34Q3S2	Any 4 consecutive sub-bins: Q3 (470) - R4 (770)		Any 1 color bin from B3 (460 nm) to B5 (475 nm)				Ammo
Blue	C4SMK-BJS-CQ34Q4T2	Any 4 consecutive sub-bins: Q3 (470) - R4 (770)		Any 1 color bin from B4 (465 nm) to B5 (475 nm)				Ammo
Blue	C4SMK-BJS-CR14Q3S2	Any 4 consecutive sub-bins: R1 (550) - S2 (934)		Any 1 color bin from B3 (460 nm) to B5 (475 nm)				Ammo
Blue	C4SMK-BJS-CR14Q4T2	Any 4 consecutive sub-bins: R1 (550) - S2 (934)		Any 1 color bin from B4 (465 nm) to B5 (475 nm)				Ammo
Blue	C4SMK-BJS-CR34Q3S2	Any 4 consecutive sub-bins: R3 (660) - S4(1100)		Any 1 color bin from B3 (460 nm) to B5 (475 nm)				Ammo
Blue	C4SMK-BJS-CR34Q4T2	Any 4 consecutive sub-bins: R3 (660) - S4(1100)		Any 1 color bin from B4 (465 nm) to B5 (475 nm)				Ammo
Blue	C4SMK-BJS-CS14Q3S2	Any 4 consecutive sub-bins: S1 (770) - T2(1310)		Any 1 color bin from B3 (460 nm) to B5 (475 nm)				Ammo
Blue	C4SMK-BJS-CS14Q4T2	Any 4 consecutive sub-bins: S1 (770) - T2(1310)		Any 1 color bin from B4 (465 nm) to B5 (475 nm)				Ammo

## C4SMJ

Color	Kit Number	Luminous Intensity (mcd)		Dominant Wavelength				Pack- age
		Min.	Max.	Color Bin	Min. (nm)	Color Bin	Max. (nm)	
Red	C4SMJ-RJS-CQ0T0BB1	390	1520	RB	619	RB	624	Bulk
Red	C4SMJ-RJS-CR34QBB1	Any 4 consecutive sub-bins: R3 (660) - S4 (1100)		RB	619	RB	624	Bulk
Red	C4SMJ-RJS-CS14QBB1	Any 4 consecutive sub-bins: S1 (770) - T2 (1310)		RB	619	RB	624	Bulk
Red	C4SMJ-RJS-CS34QBB1	Any 4 consecutive sub-bins: S3 (934) - T4 (1520)		RB	619	RB	624	Bulk
Red	C4SMJ-RJS-CQ0T0BB2	390	1520	RB	619	RB	624	Ammo
Red	C4SMJ-RJS-CR34QBB2	Any 4 consecutive sub-bins: R3 (660) - S4 (1100)		RB	619	RB	624	Ammo
Red	C4SMJ-RJS-CS14QBB2	Any 4 consecutive sub-bins: S1 (770) - T2 (1310)		RB	619	RB	624	Ammo
Red	C4SMJ-RJS-CS34QBB2	Any 4 consecutive sub-bins: S3 (934) - T4 (1520)		RB	619	RB	624	Ammo

### Notes:

1. The above kit numbers represent order codes that include multiple intensity-bin and color-bin codes. Only one intensity-sub-bin code and one color-bin code will be shipped on each reel. Selected single intensity-bin, single color-bin codes will be orderable in certain quantities. For example, any four consecutive sub-bins from V1 to W2 mean only one intensity bin with four sub-bins of the following brightness ranges (V1-V4, V2-W1, V3-W2) will be shipped by Cree. For example, any one-color bin from G7 to G9 means only one color bin (G7 or G8 or G9) will be shipped by Cree.
2. Please refer to the "Cree LED Lamp Reliability Test Standards" document for reliability test conditions.
3. Please refer to the "Cree LED Lamp Soldering & Handling" document for information about how to use this LED product safely.

# Graphs

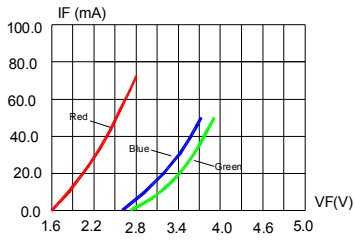

FIG.1 FORWARD CURRENT VS. FORWARD VOLTAGE.

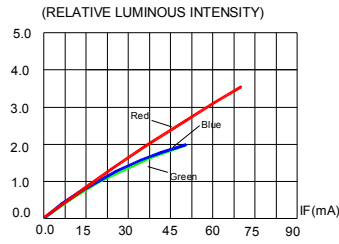

FIG.2 RELATIVE LUMINOUS INTENSITY VS. FORWARD CURRENT

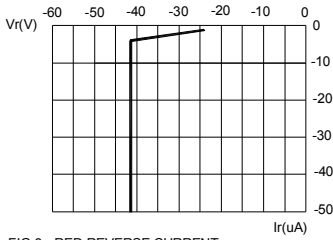

FIG.3a RED REVERSE CURRENT VS. REVERSE VOLTAGE.

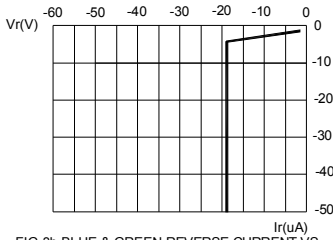

FIG.3b BLUE & GREEN REVERSE CURRENT VS. REVERSE VOLTAGE.

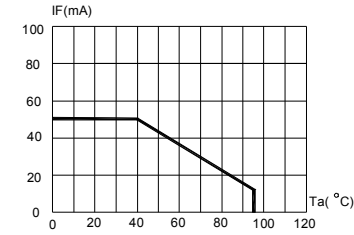

FIG.4a RED MAXIMUM FORWARD DC CURRENT VS AMBIENT TEMPERATURE (Tjmax=105°C)

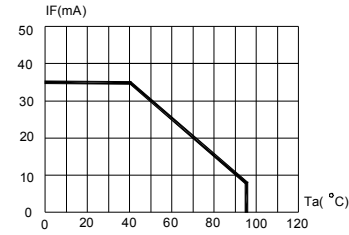

FIG.4b BLUE & GREEN MAXIMUM FORWARD DC CURRENT VS AMBIENT TEMPERATURE (Tjmax=105°C)

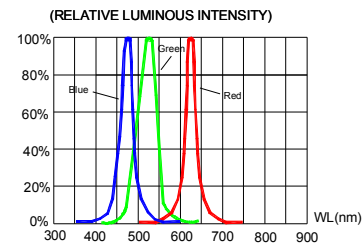

FIG.5 RELATIVE LUMINOUS INTENSITY VS. WAVELENGTH.

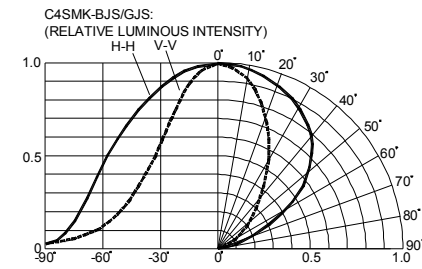
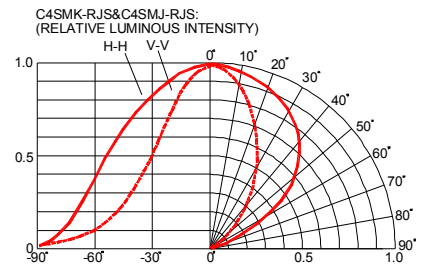

FIG.6 RED & BLUE&GREEN FAR FIELD PATTERN



The above data are collected from statistical figures that do not necessarily correspond to the actual parameters of each single LED. Hence, these data will be changed without further notice.

## Mechanical Dimensions

All dimensions are in mm. Tolerance is  $\pm 0.25$  mm unless otherwise noted.

An epoxy meniscus may extend about 1.5 mm down the leads.

Burr around bottom of epoxy may be 0.5 mm max.

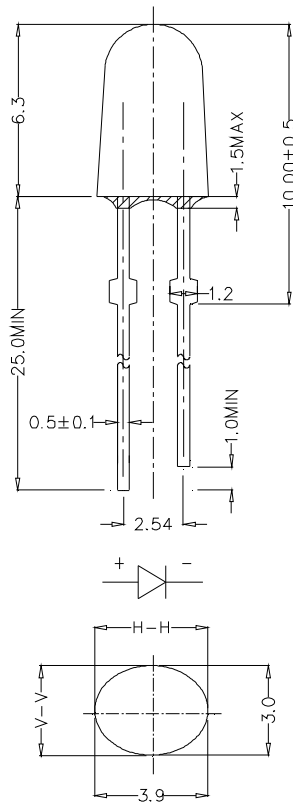

## Notes

### RoHS Compliance

The levels of environmentally sensitive, persistent biologically toxic (PBT), persistent organic pollutants (POP), or otherwise restricted materials in this product are below the maximum concentration values (also referred to as the threshold limits) permitted for such substances, or are used in an exempted application, in accordance with EU Directive 2002/95/EC on the restriction of the use of certain hazardous substances in electrical and electronic equipment (RoHS), as amended through April 21, 2006.

### Vision Advisory Claim

Users should be cautioned not to stare at the light of this LED product. The bright light can damage the eye.



## Kit Number System

Cree LED lamps are tested and sorted into performance bins. A bin is specified by ranges of color, forward voltage, and brightness. Sorted LEDs are packaged for shipping in various convenient options. Please refer to the "Cree LED Lamp Packaging Standard" document for more information about shipping and packaging options.

Cree LEDs are sold by order codes in combinations of bins called kits. Order codes are configured in the following manner:

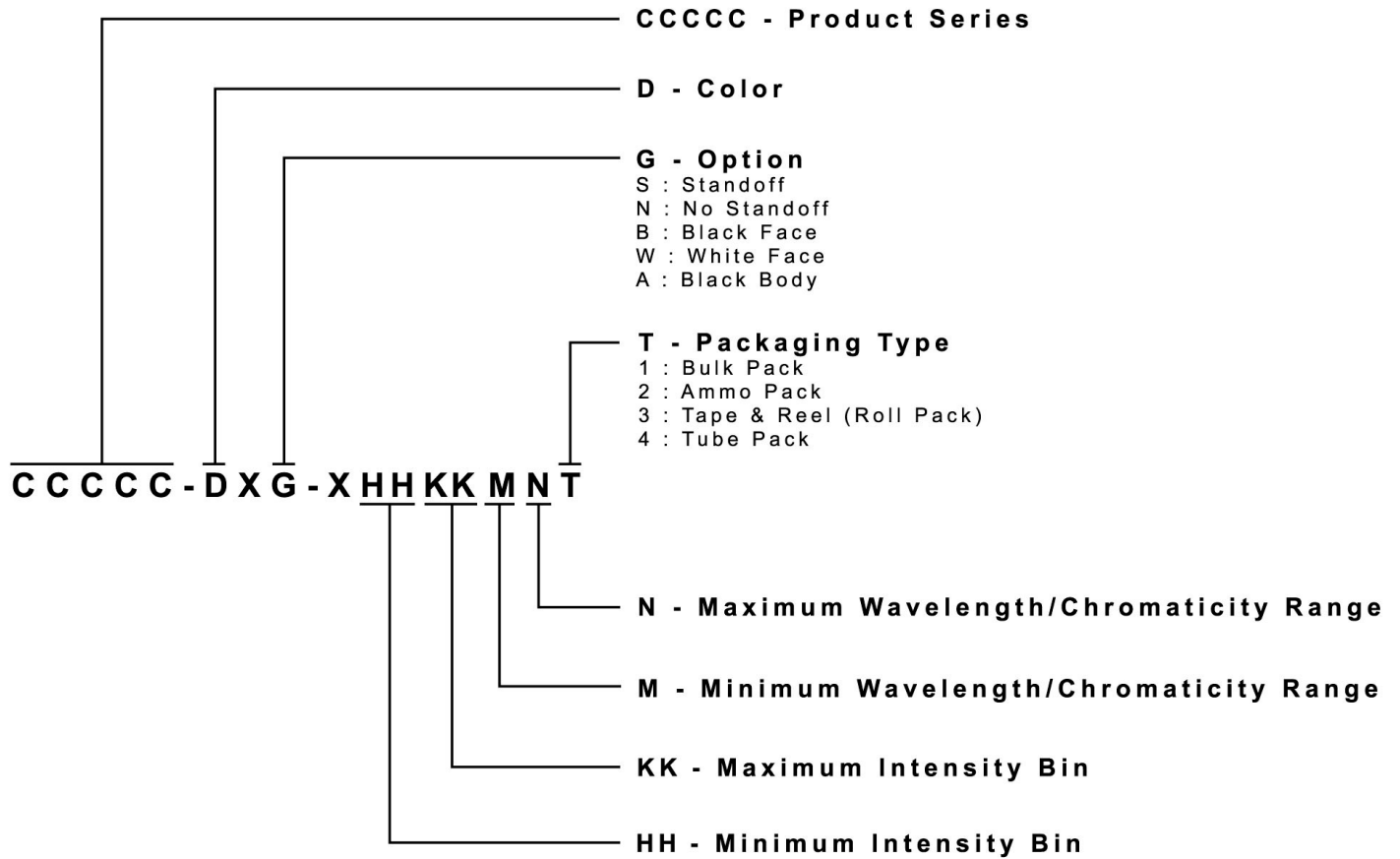



## Package

### Features:

- The LEDs are packed in cardboard boxes after packaging in normal or anti-electrostatic bags.
- Cardboard boxes will be used to protect the LEDs from mechanical shock during transportation.
- The boxes are not water resistant, and they must be kept away from water and moisture.
- There are two types of packaging: Bulk Pack and Ammo Pack.
- Max 500 pcs per bulk and max 3000 pcs per ammo.

### Bulk Pack Packaging Type:

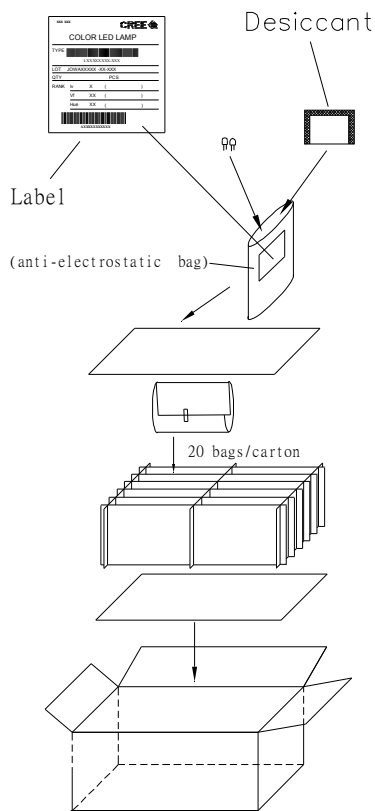

### Ammo Pack Packaging Type:

