

DC-DC Converter UNIT

KAW Series (30 W WIDE INPUT RANGE DC-DC CONVERTER)

FEATURES

- SIX-SIDE SHIELDED CASE
- 9-18V,18-36V,36-72V WIDE INPUT RANGE
- SHORT CIRCUIT PROTECTION
- REMOTE ON/OFF AND TRIM
- NO EXTERNAL COMPONENTS REQUIRED
- TYPICAL EFFICIENCY 80%
- 100% BURNED IN
- INDUSTRY STANDARD PACKAGE
- MTBF > 700,000 HOURS



● OUTPUT SPECIFICATIONS

Voltage Setpoint Accuracy	+/-2% max
Temperature Coefficient	+/-0.03%/°C
Ripple & Noise (20MHz BW)	100mVp-p max
Line Regulation ¹	+/-0.2% max
Load Regulation ²	+/-0.2% max
Short Circuit Protection	Continuous
OverVoltage Protection	Built-in

External Trim Adj. Range +/-10%

● ENVIRONMENTAL SPECIFICATIONS

Operating Temperature	-25 °C to +71 °C
Storage Temperature	-55 °C to +100 °C
Cooling	Free-Air Convection

ALL SPECIFICATIONS TYPICAL AT NOMINAL LINE, FULL LOAD , AND 25 °C UNLESS OTHERWISE NOTED.

● INPUT SPECIFICATIONS

Input Voltage Range	2:1 INPUT RANGE
Input Filter	Pi Network

● GENERAL SPECIFICATIONS

Efficiency	75% min
Transient Response(Full to 1/2 Load)	<500uSec
Isolation Voltage ³	1000 VDC min
Isolation Resistance	10 ⁹ ohms min
Switching Frequency	100 KHz min
MTBF	700,000 Hours
Weight	110g Typ
Case Material	Six-Side Shielded Case
Case Size	50.8mm*50.8mm*21mm

¹ High Line to Low Line.

² Load Regulation is for output load current change from 10% to 100%.

³ For 10 seconds

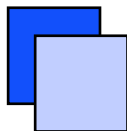

DC-DC Converter UNIT

KAW Series (30 W WIDE INPUT RANGE DC-DC CONVERTER)

● SELECTION GUIDE 2:1 30W OUTPUT

MODEL NUMBER	INPUT VOLTAGE (VDC)	OUTPUT VOLTAGE (VDC)	OUTPUT CURRENT (mA)	INPUT ⁴ CURRENT(mA)		EFF (%) ⁵	ISOLATION (VDC)
				FULL LOAD	NO LOAD		
				KAWS-1205	9-18		
KAWS-1212	9-18	12	2500	3086	40	81	1000
KAWS-1215	9-18	15	2000	3096	38	81	1000
KAWD-1205	9-18	+/-5	+/-2500	2637	40	79	1000
KAWD-1212	9-18	+/-12	+/-1250	3125	40	80	1000
KAWD-1215	9-18	+/-15	+/-1000	3125	38	80	1000
KAWS-2405	18-36	5	5000	1302	20	80	1000
KAWS-2412	18-36	12	2500	1470	18	85	1000
KAWS-2415	18-36	15	2000	1470	18	85	1000
KAWD-2405	18-36	+/-5	+/-2500	1302	20	80	1000
KAWD-2412	18-36	+/-12	+/-1250	1470	18	85	1000
KAWD-2415	18-36	+/-15	+/-1000	1470	18	85	1000
KAWS-4805	36-72	5	5000	651	10	80	1000
KAWS-4812	36-72	12	2500	762	9	82	1000
KAWS-4815	36-72	15	2000	762	9	82	1000
KAWD-4805	36-72	+/-5	+/-2500	651	10	80	1000
KAWD-4812	36-72	+/-12	+/-1250	762	9	82	1000
KAWD-4815	36-72	+/-15	+/-1000	762	9	82	1000

Note: Other input to output voltages may be available. Please contact factory.

⁴ NOMINAL INPUT VOLTAGE.

⁵ NOMINAL INPUT VOLTAGE, FULL LOAD.



DC-DC Converter UNIT

KAW Series (30 W WIDE INPUT RANGE DC-DC CONVERTER)

● SIMPLIFIED SCHEMATIC

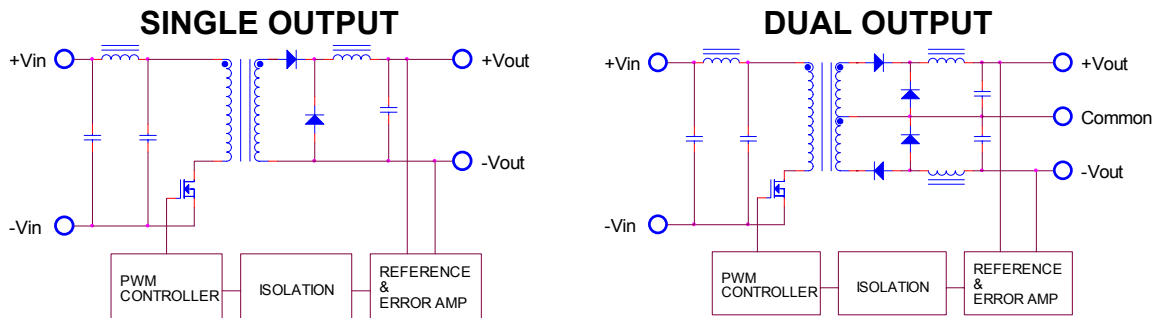

● MECHANICAL DIMENSIONS

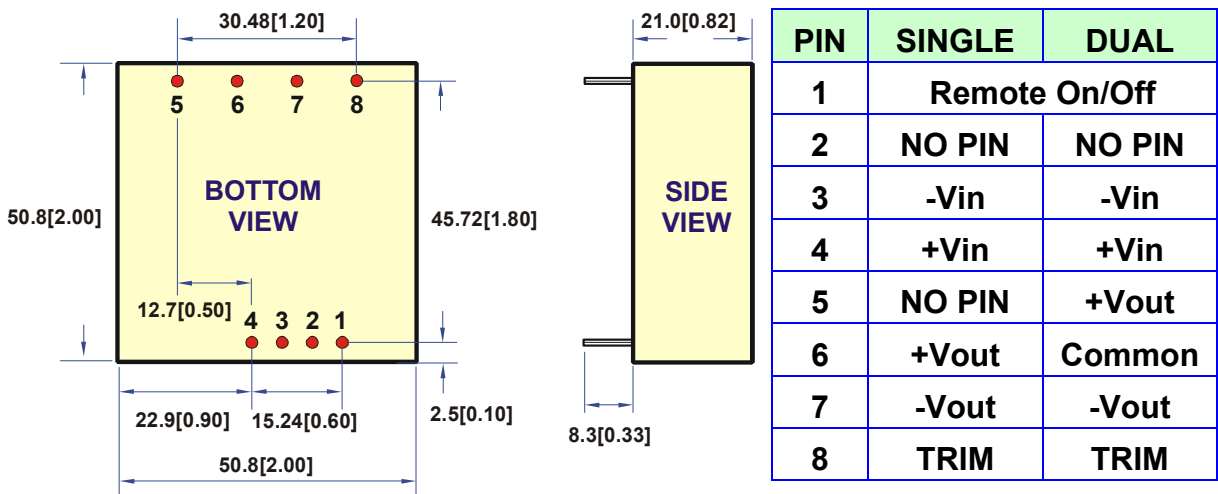

All dimensions are in millimeters[inches]

Remote On/Off Control			
Control Input	PIN1	Control Common	PIN3
Control Voltage		Converter Shutdown Idle Current	10mA
ON	>+2.5VDC or Open Circuit	Logic Compatibility	CMOS or Open
OFF	<+0.8VDC or Jumper to PIN3		Collector TTL



DC-DC Converter UNIT

KAW Series (30 W WIDE INPUT RANGE DC-DC CONVERTER)

● RECOMMENDED FOOTPRINT DETAILS

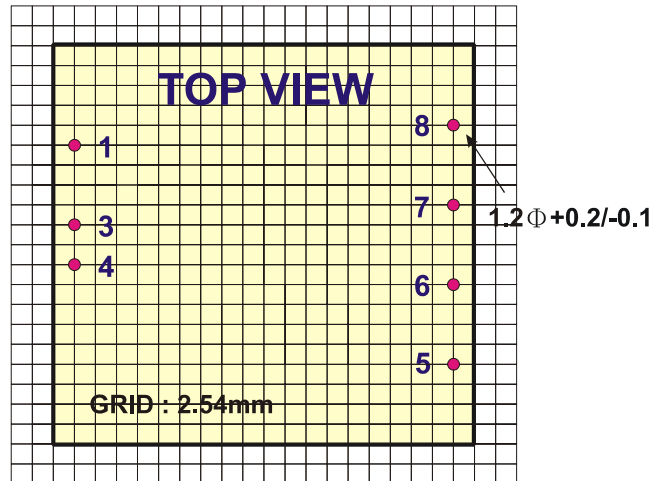

● TYPICAL APPLICATIONS

SINGLE OUTPUT

DUAL OUTPUT

FIXED VOLTAGE OUTPUT

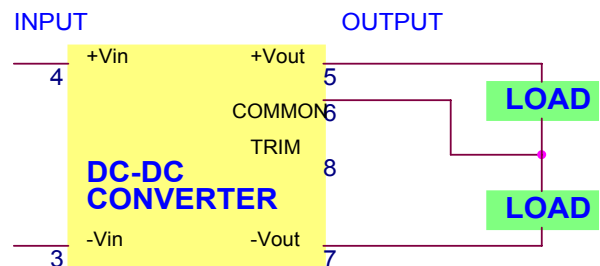
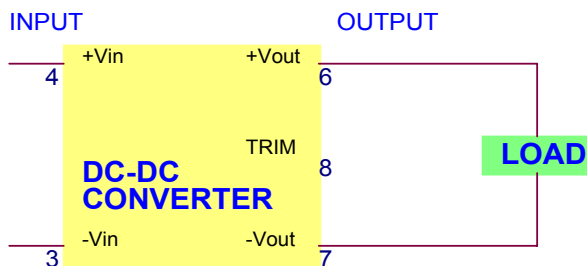

TRIM CONNECTIONS USING A TRIMPOT

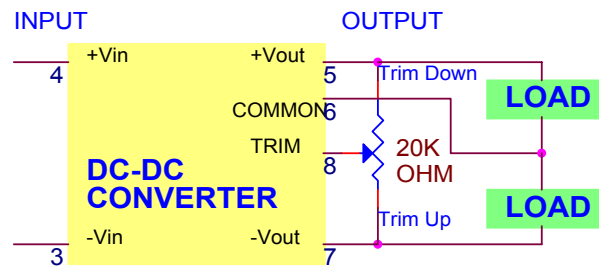
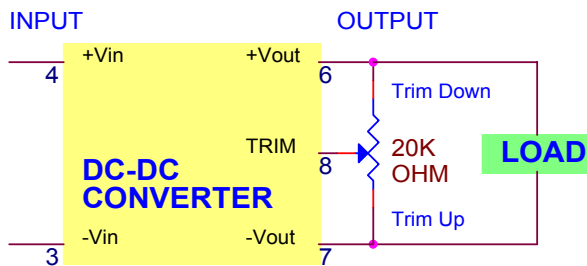

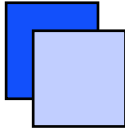

DC-DC Converter UNIT

KAW Series (30 W WIDE INPUT RANGE DC-DC CONVERTER)

FIXED-VALUE TRIM DOWN RESISTOR

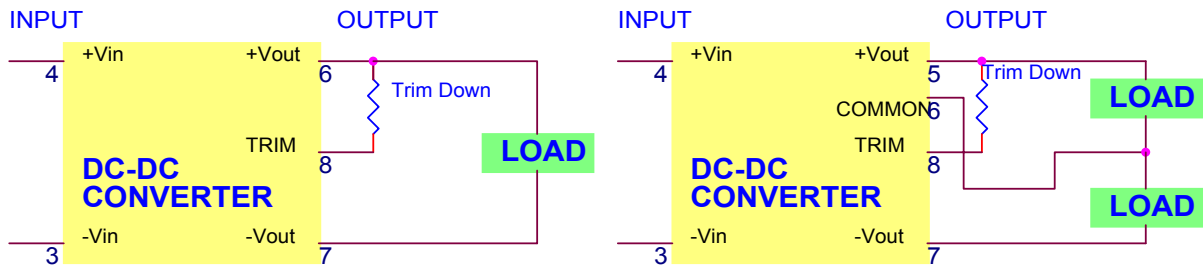

FIXED-VALUE TRIM UP RESISTOR

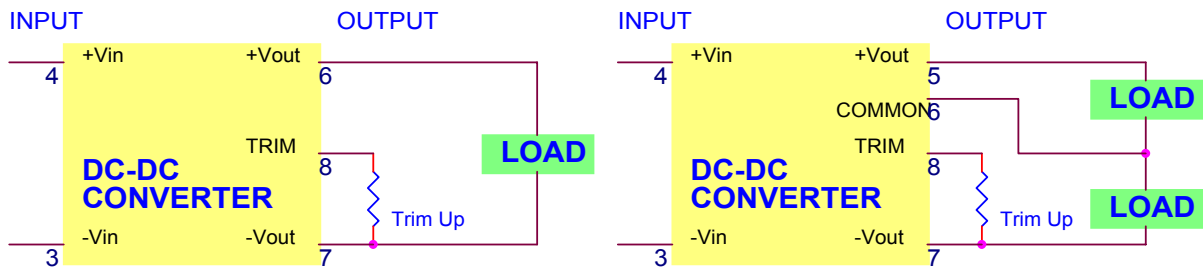

● TEMPERATURE DERATING

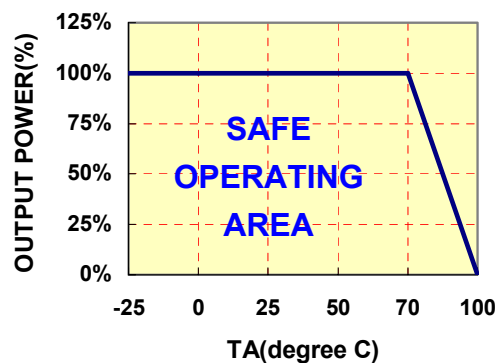

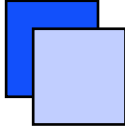

DC-DC Converter UNIT

KAW Series (30 W WIDE INPUT RANGE DC-DC CONVERTER)

KAW SERIES APPLICATION NOTES:

EXTERNAL CAPACITANCE REQUIREMENTS:

No external capacitance is required for operation of the KAW series.

To meet the reflected ripple requirements of the converter, an input impedance of less than 0.5 ohm from DC to 220KHz is required.

External output capacitance is not required for operation, however it is recommended that 10uF tantalum and 0.1uF ceramic capacitance be selected for reduced system noise.

Additional output capacitance may be added for increased filtering, but should not exceed 2200uF.

Negative Outputs:

A negative output voltage may be obtained by connecting the +OUT to circuit ground and connecting -OUT as the negative output.

FOR MORE INFORMATION CALL:

Power Systems – The Power Solution

Ilfeld-Auenstein (Germany) Dörnet 8 Tel: + 49 / 70 62 / 67 59 – 6 Fax: + 49 / 70 62 / 67 59 -80

E-mail: Info@Power-Systems.de Home Page: www.Power-Systems.de
