

PCB LAYOUT - COMPONENT VIEW

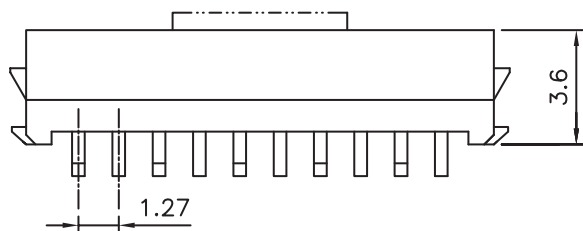

Pick & Place Pad

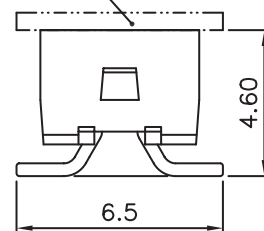

MATERIAL:
 HOUSING MATERIAL: PA6T
 FLAMABILITY RATING: UL94-V0
 COLOR: RED
 CONTACT MATERIAL: PHOSPHOR BRONZE
 CONTACT TYPE: STAMPED
 CONTACT PLATING: MATT TIN OVER NICKEL
 QUALITY CLASS: 25 MATING CYCLES
 PITCH: 2.54 MM PER ROW

ENVIRONMENTAL:
 OPERATING TEMPERATURE: -40°C UP TO 105°C
 COMPLIANCE: LEAD FREE AND ROHS

ELECTRICAL:
 CURRENT RATING: 1.5A PER PIN (PCB PIN)
 WORKING VOLTAGE: 100VAC
 INSULATION RESISTANCE: >1000MOHM
 DIELECTRIC WITHSTANDING VOLT.: 500VAC/MN
 CONTACT RESISTANCE: 10mOHM MAX

STANDARD
 RoHS CERTIFIED: E323964 / MOD. NUMBER 69035728xx7x

SOLDERING:
 REFLOW PROCESS ONLY

DIMENSION:
 DIM.A= 1.27 x No. of Spaces
 DIM.B= DIM.A + 3.30
 DIM.C= DIM.A + 4.30

AVAILABLE
 xx : 4 TO 26 CIRCUITS

PACKAGING:
 TAPE & REEL

RoHS Compliant			
H	06-MAR-13	C DIM ADD	QL
REV	DATE	FILE	BY

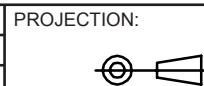

GENERAL TOLERANCE
 .X = +/- 0.2
 .XX = +/- 0.15



APPROVAL: RJ

UNIT: MM
 SCALE:
 SHEET: 1/2
 DRAW: EAGER

DESCRIPTION: MM MALE SMT CONNECTOR WITHOUT LATCH AND WITHOUT POLARIZATION

WERI PART NO: 690 357 28 xx 76

SIZE
A4

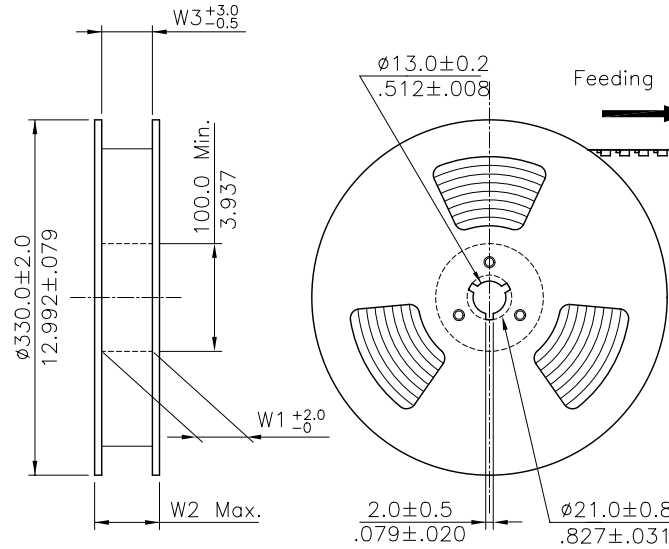

NOTES:

1. 10 sprocket hole pitch cumulative tolerance ± 0.20 mm.
2. Carrier camber not to exceed 1 mm in 100 mm.
3. Material :Transparent Anti-static Polysyrene.
4. All dimensions meet EIA-481-3 requirements.
5. Thickness : 0.40 ± 0.05 mm.
6. Packing length per 22" Reel : 30.6 Meters.
7. Component load per 13" Reel :1000 pcs.

Circuits	Dimension					Packing (Reel/Caton)
	E	F	W1	W2	W3	
4	16.0(.630)	-	16.5(.650)	22.5(.886)	16.5(.650)	11
6~10	24.0(.945)	-	24.5(.965)	30.5(1.201)	24.5(.965)	9
10~14	32.0(1.260)	28.40(1.118)	32.5(1.280)	38.5(1.516)	32.5(1.280)	7
16~22	44.0(1.732)	40.40(1.596)	44.5(1.752)	50.5(1.988)	44.5(1.752)	5
24~26	56.0(2.205)	52.40(2.063)	56.5(2.224)	62.5(2.461)	56.5(2.224)	4

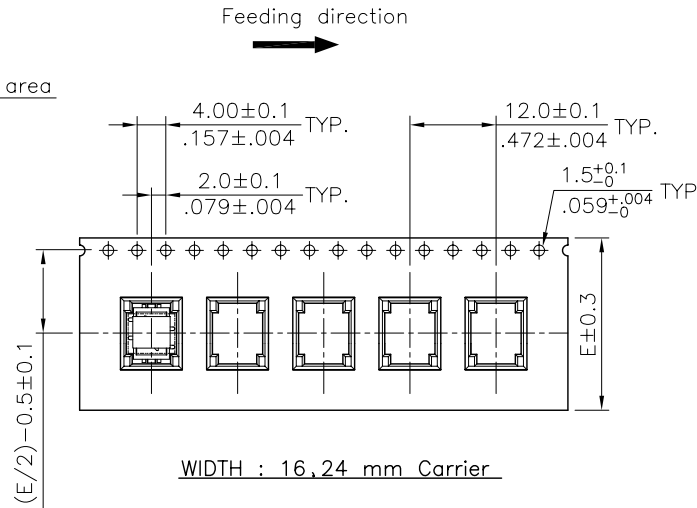
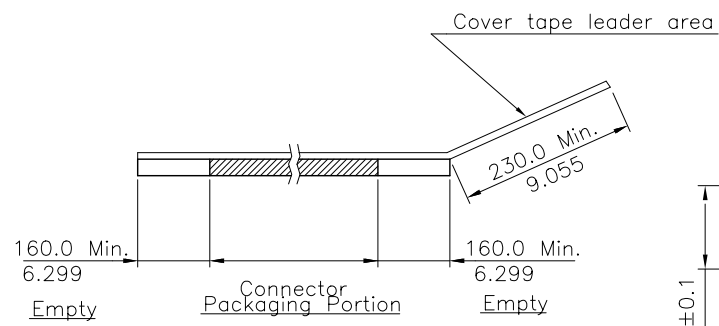

WIDTH : 16,24 mm Carrier

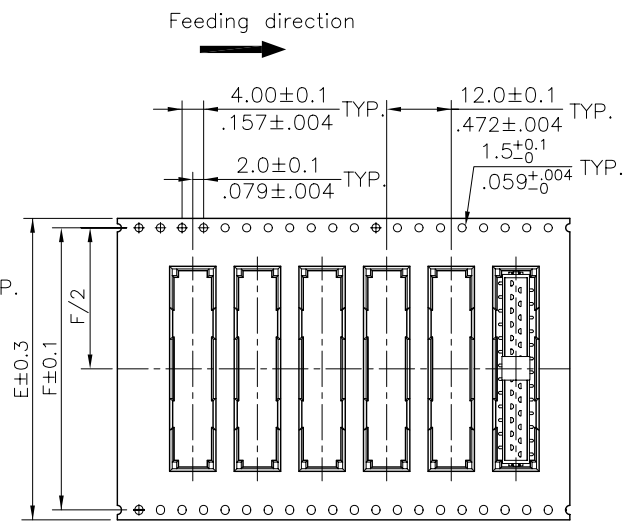

WIDTH : 32.44.56 mm Carrier

RoHS Compliant				PROJECTION: 	GENERAL TOLERANCE .X = \pm 0.2 .XX = \pm 0.15		DESCRIPTION: MM MALE SMT CONNECTOR WITHOUT LATCH AND POLARIZATION	SIZE A4
G								
F				APPROVAL: RJ	UNIT: MM	WERI PART NO: 690 357 28 xx 76		
E					SCALE:			
D					SHEET: 2/2			
C					DRAW: EAGER			
B								
A								
REV	DATE	FILE	BY					