



UF201 THRU UF207

ULTRA FAST RECOVERY SILICON RECTIFIER

Reverse Voltage - 50 to 1000 Volts Forward Current - 2.0 Ampere

FEATURES

- The plastic package carries Underwriters Laboratory Flammability Classification 94V-0
- Ultra fast switching for high efficiency
- Low reverse leakage
- High forward surge current capability
- High temperature soldering guaranteed:
250°C/10 seconds, 0.375" (9.5mm) lead length, 5 lbs. (2.3kg) tension

MECHANICAL DATA

Case: JEDEC DO-15 molded plastic body
Terminals: Plated axial leads, solderable per MIL-STD-750, Method 2026
Polarity: Color band denotes cathode end
Mounting Position: Any
Weight: 0.014 ounce, 0.40 grams

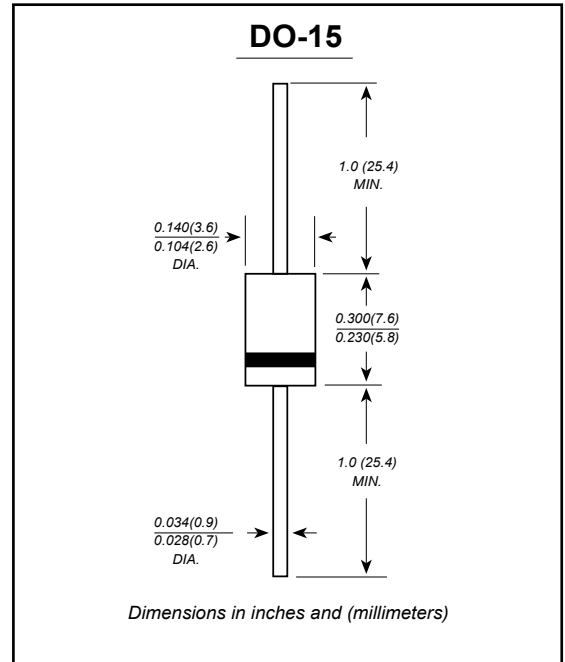

MAXIMUM RATINGS AND ELECTRICAL CHARACTERISTICS

Ratings at 25°C ambient temperature unless otherwise specified.
 Single phase half-wave 60Hz, resistive or inductive load, for capacitive load current derate by 20%.

Characteristic	SYMBOLS	UF 201	UF 202	UF 203	UF 204	UF 205	UF 206	UF 207	UNITS
Maximum repetitive peak reverse voltage	V_{RRM}	50	100	200	400	600	800	1000	V
Maximum RMS voltage	V_{RMS}	35	70	140	280	420	560	700	V
Maximum DC blocking voltage	V_{DC}	50	100	200	400	600	800	1000	V
Maximum average forward rectified current 0.375" (9.5mm) lead length at $T_A=50^\circ\text{C}$	$I_{(AV)}$	2.0							A
Peak forward surge current 8.3ms single half sine-wave superimposed on rated load (JEDEC Method)	I_{FSM}	60.0							A
Maximum instantaneous forward voltage at 2.0A	V_F	1.0		1.30		1.70		V	
Maximum DC reverse current $T_A=25^\circ\text{C}$ at rated DC blocking voltage $T_A=100^\circ\text{C}$	I_R	5.0 100.0							μA
Maximum reverse recovery time (NOTE 1)	t_{rr}	50				75			ns
Typical junction capacitance (NOTE 2)	C_J	50				30			pF
Typical thermal resistance (NOTE 3)	$R_{\theta JA}$	50.0							$^\circ\text{C/W}$
Operating junction and storage temperature range	T_J, T_{STG}	-65 to +150							$^\circ\text{C}$

- Note:** 1. Reverse recovery condition $I_F=0.5\text{A}, I_R=1.0\text{A}, I_{rr}=0.25\text{A}$
 2. Measured at 1MHz and applied reverse voltage of 4.0V D.C.
 3. Thermal resistance from junction to ambient at 0.375" (9.5mm) lead length, P.C.B. mounted



UF201 THRU UF207

RATINGS AND CHARACTERISTIC CURVES

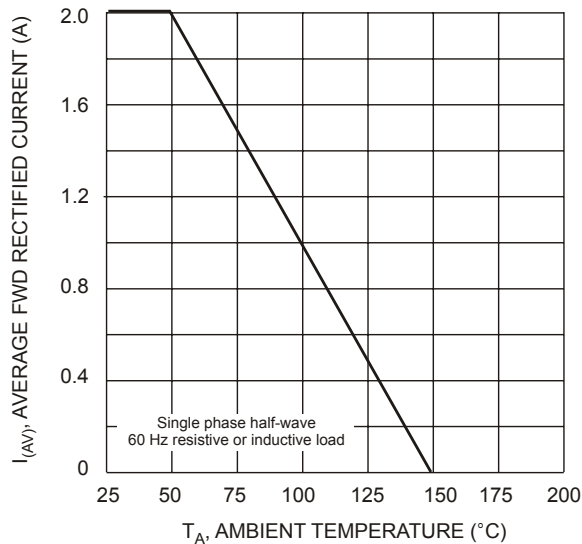

Fig. 1 Forward Current Derating Curve

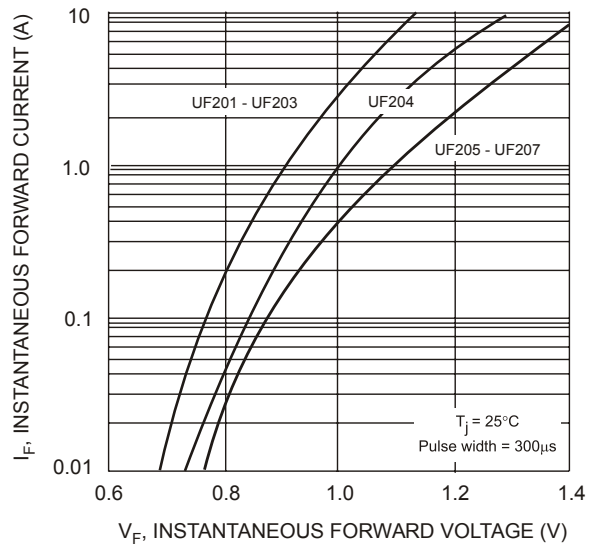

Fig. 2 Typical Forward Characteristics

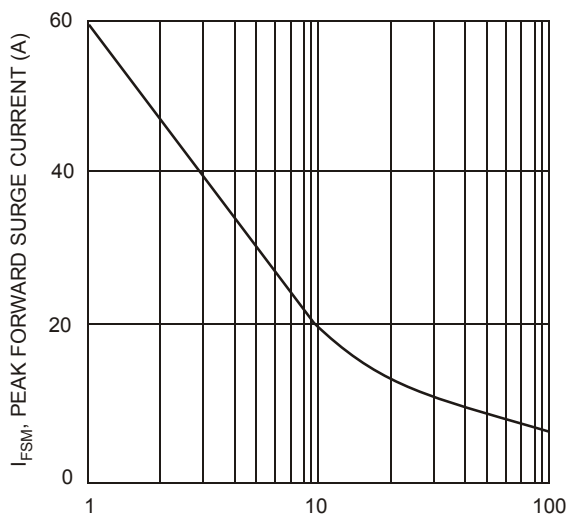

Fig. 3 Peak Forward Surge Current

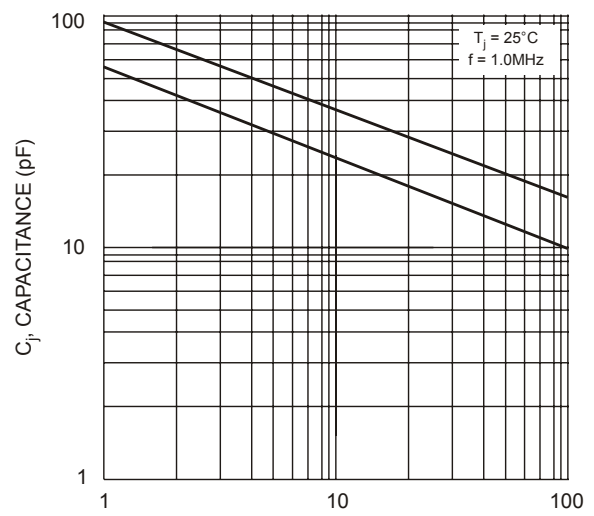
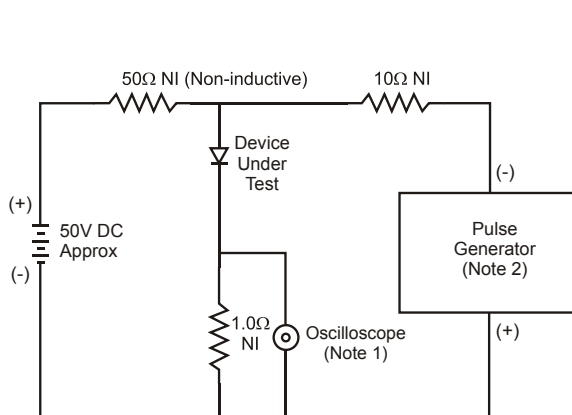
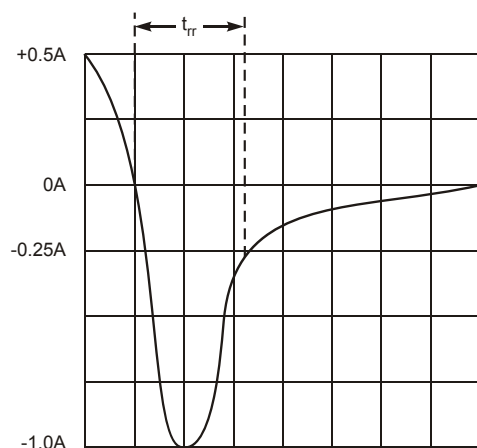

Fig. 4 Typical Junction Capacitance



- Notes:
1. Rise Time = 7.0ns max. Input Impedance = 1.0M Ω , 22pF.
 2. Rise Time = 10ns max. Input Impedance = 50 Ω .



Set time base for 50/100 ns/cm

Fig. 5 Reverse Recovery Time Characteristic and Test Circuit